

**Canon** EF LENS

**EF24-70mm f/2.8L II USM**



**ULTRASONIC**

**ENG**  
Instructions

## Thank you for purchasing a Canon product.

Canon's EF24-70mm f/2.8L II USM is a high-performance standard zoom lens, for use with EOS cameras.

- "USM" stands for Ultrasonic Motor.

### Features

---

1. Use of super UD lens elements, UD lens elements, and two types of aspherical lens elements giving superior definition.
2. Using a fluorine coating on the foremost and rearmost lens surfaces allows adhered dirt to be removed more easily than before.
3. Ultrasonic motor (USM) for fast, quiet autofocus.
4. Manual focusing is available after the subject comes into focus in autofocus mode (ONE SHOT AF).
5. Circular aperture for producing beautiful softfocus images.
6. Tight seal structure ensures excellent dustproof and drip-proof performance.

# Safety Precautions

## Handling Cautions

- **If the lens is taken from a cold environment into a warm one, condensation may develop on the lens surface and internal parts.** To prevent condensation in this case, first put the lens into an airtight plastic bag before taking it from a cold to warm environment. Then take out the lens after it has warmed gradually. Do the same when taking the lens from a warm environment into a cold one.
- Do not leave the lens in excessive heat such as in a car in direct sunlight. **High temperatures can cause the lens to malfunction.**

## Safety Precautions

- **Do not look at the sun or a bright light source through the lens or camera.** Doing so could result in loss of vision. Looking at the sun directly through the lens is especially hazardous.
- **Whether it is attached to the camera or not, do not leave the lens under the sun without the lens cap attached.** This is to prevent the lens from concentrating the sun's rays, which could cause a fire.

## Conventions used in this instruction



Warning to prevent lens or camera malfunction or damage.



Supplementary notes on using the lens and taking pictures.

## Safety Precautions

This device complies with Part 15 of the FCC Rules. Operation is subject to the following two conditions: (1) This device may not cause harmful interference, and (2) this device must accept any interference received, including interference that may cause undesired operation.

Do not make any changes or modifications to the equipment unless otherwise specified in the instructions. If such changes or modifications should be made, you could be required to stop operation of the equipment.

This equipment has been tested and found to comply with the limits for a class B digital device, pursuant to part 15 of the FCC Rules. These limits are designed to provide reasonable protection against harmful interference in a residential installation. This equipment generates, uses and can radiate radio frequency energy and, if not installed and used in accordance with the instructions, may cause harmful interference to radio communications.

However, there is no guarantee that interference will not occur in a particular installation. If this equipment does cause harmful interference to radio or television reception, which can be determined by turning the equipment off and on, the user is encouraged to try to correct the interference by one or more of the following measures:

- Reorient or relocate the receiving antenna.
- Increase the separation between the equipment and receiver.
- Consult the dealer or an experienced radio/TV technician for help.

---

This Class B digital apparatus complies with Canadian ICES-003.

---

# Nomenclature

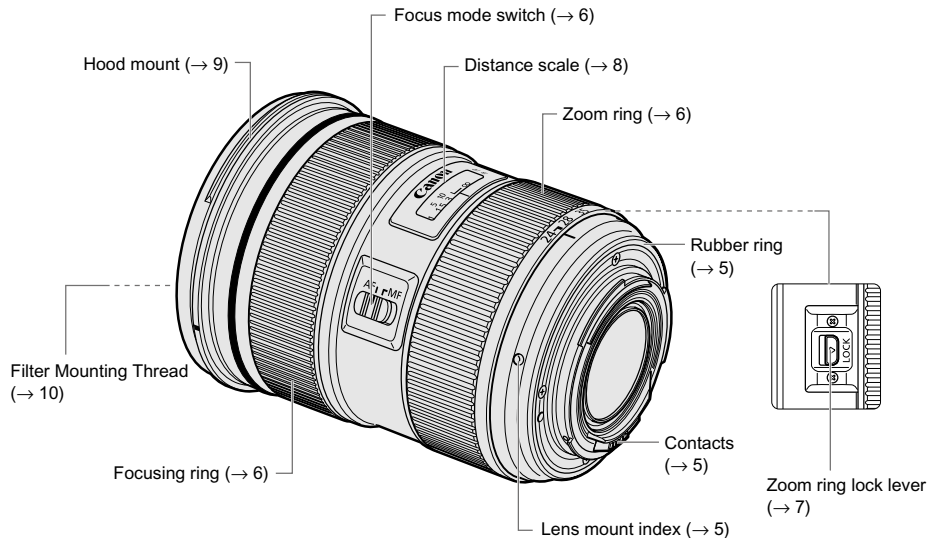

● For detailed information, reference page numbers are provided in parentheses (→ \*\*).

# 1. Mounting and Detaching the Lens

See your camera's instructions for details on mounting and detaching the lens.

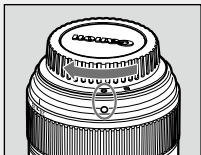
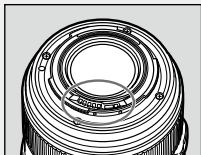

- After detaching the lens, place the lens with the rear end up to prevent the lens surface and contacts from getting scratched.
- If the contacts get soiled, scratched, or have fingerprints on them, corrosion or faulty connections can result. The camera and lens may not operate properly.
- If the contacts get soiled or have fingerprints on them, clean them with a soft cloth.
- If you remove the lens, cover it with the dust cap. To attach it properly, align the lens mount index and the  $\bigcirc$  index of the dust cap as shown in the diagram, and turn clockwise. To remove it, reverse the order.



The lens mount has a rubber ring for enhanced dust- and water-resistance. The rubber ring may cause slight abrasions around the camera's lens mount, but this will not cause any problems. If the rubber ring becomes worn, it is replaceable by a Canon Service Center at cost.

## 2. Setting the Focus Mode

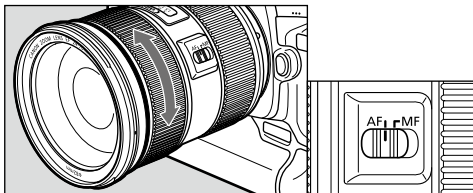

To shoot in autofocus (AF) mode, set the focus mode switch to AF.

To shoot in manual focus (MF) mode, set the focus mode switch to MF, and focus by turning the focusing ring.

The focusing ring always works, regardless of the focus mode.

 After autofocus in ONE SHOT AF mode, focus manually by pressing the shutter button halfway and turning the focusing ring. (Full-time manual focus)

## 3. Zooming

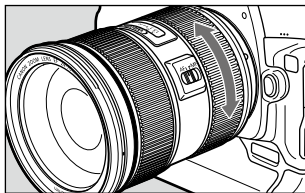

To zoom, rotate the zoom ring.

 Be sure to finish zooming before focusing. Zooming after focusing can affect the focus.

## 4. Fixing the Zoom Ring

The zoom ring can be fixed to keep the lens at the shortest point. This function is convenient for carrying a camera on a strap because it prevents the lens from extending.

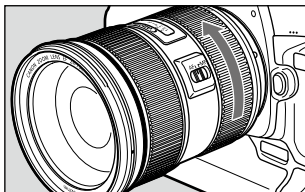
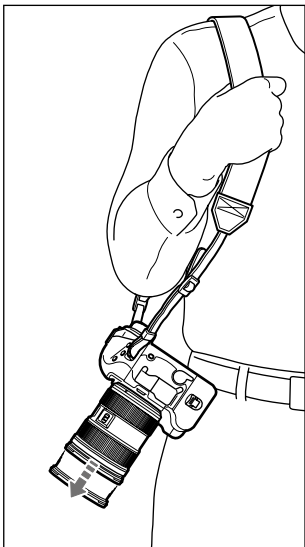

- 1 Rotate the zoom ring to the widest position (24 mm).

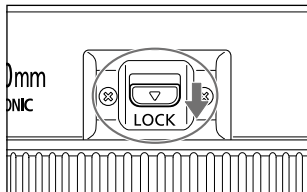

- 2 Slide the zoom ring lock lever in the direction indicated by the arrow.
  - To release the zoom ring, slide the zoom ring lock lever in the direction opposite to the arrow.

 The zoom ring can only be locked at maximum wide angle.



## 5. Infinity Compensation Mark

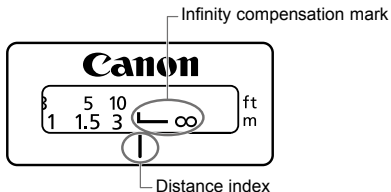

To compensate for shifting of the infinity focus point that results from changes in temperature. The infinity position at normal temperature is the point at which the vertical line of the distance scale L mark is aligned with the distance index.

- 🔧 For accurate focusing in MF on subjects at infinity distance, look through the viewfinder while rotating the focusing ring.

## 6. Hood

The EW-88C hood cuts out unwanted light and protects the front of the lens from rain, snow, and dust.

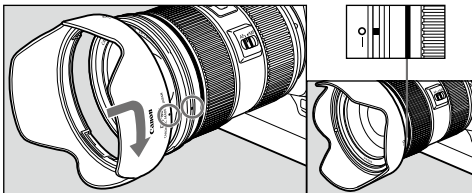

### ●Attaching

To attach the hood, align the hood's attachment position mark with the red dot on the front of the lens, then turn the hood as shown by the arrow until the lens' red dot is aligned with the hood's stop position mark.

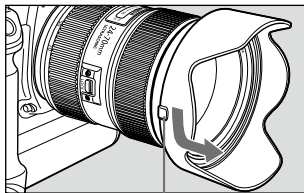

Button

### ●Removing

To remove the hood, hold down the button on the side and turn the hood in the direction of the arrow until the position mark on the hood aligns with the red dot. The hood can be reverse-mounted on the lens for storage.

ⓘ ● If the hood is not attached properly, vignetting (darkening of the perimeter of the picture) may occur.

● When attaching or detaching the hood, grasp the base of the hood to turn it. To prevent deformation, do not grasp the rim of the hood to turn it.

## 7. Filters (sold separately)

You can attach filters to the filter mounting thread on the front of the lens.

- Only one filter may be attached.
- If you need a polarizing filter, use the Canon Circular Polarizing Filter PL-C B (82 mm).
- To adjust the polarizing filter, first remove the lens hood.

## 8. Extension Tubes (Sold Separately)

You can attach extension tube EF12 II or EF25 II for magnified shots. The shooting distance and magnification are shown below.

		Focusing Distance Range (mm)		Magnification (×)	
		Close distance	Long distance	Close distance	Long distance
EF12 II	24mm	178	190	0.63	0.50
	70mm	259	523	0.45	0.18
EF25 II	24mm	Incompatible			
	70mm	229	331	0.74	0.41

 MF mode is recommended for accurate focusing.

# Specifications

<b>Focal Length/Aperture</b>	24-70mm f/2.8
<b>Lens Construction</b>	13 groups, 18 elements
<b>Minimum Aperture</b>	f/22
<b>Angle of View</b>	Diagonal: 84° – 34° Vertical: 53° – 19° 30' Horizontal: 74° – 29°
<b>Min. Focusing Distance</b>	0.38 m/1.25 ft.
<b>Max. Magnification</b>	0.21x (at 70 mm/2.76 inch)
<b>Field of View</b>	369 x 554 – 134 x 202 mm/14.53 x 21.81 – 5.28 x 7.95 inch (at 0.38 m/1.25 ft.)
<b>Filter Diameter</b>	82 mm/3.23 inch
<b>Max. Diameter and Length</b>	88.5 x 113.0 mm/3.48 x 4.45 inch
<b>Weight</b>	Approx. 805 g/28.4 oz
<b>Hood</b>	EW-88C
<b>Lens Cap</b>	E-82U/E-82 II
<b>Case</b>	LP1219

- The lens length is measured from the mount surface to the front end of the lens.  
Add 21.5 mm to include the E-82U lens cap and dust cap, and 24 mm for the E-82 II.
- The size and weight listed are for the lens only, except as indicated.
- Extenders cannot be used with this lens. In addition, there are no close-up lenses designed for use with this lens.
- Aperture settings are specified on the camera.
- All data listed is measured according to Canon standards.
- Product specifications and appearance are subject to change without notice.

**Canon**