

FUJINON

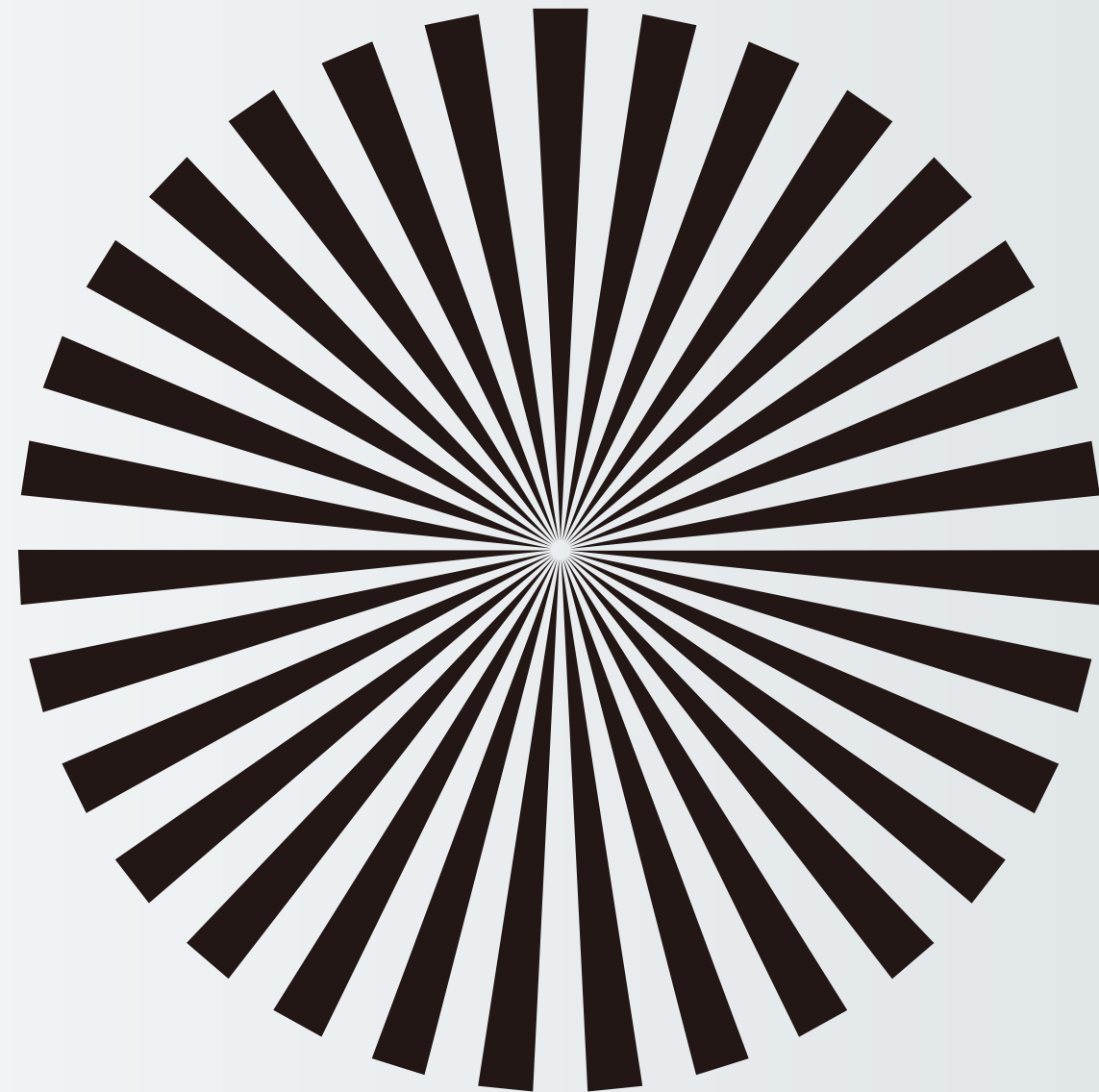

FUJIFILM
Value from Innovation



Focused on the Future
FUJINON

TELEVISION LENSES & CINE LENSES
2021

FUJIFILM

FUJIFILM Corporation

Optical Device & Electronic Imaging Product Division

http://www.fujifilm.com/products/optical_devices/tv_cine/

Due to a continuous process of product improvement, design and specification are subject to change without notice.



For Your Safety

Be certain to read the instruction for use before using any equipment.

Printed in Japan

Television Lenses

Fujifilm has been engaged in the development and production of TV Lenses for over 50 years. FUJINON TV Lenses have supported image creation throughout the world with our own unique technologies such as, optical design development, advanced manufacturing capabilities and exceptional quality. All FUJINON lenses are intentionally designed keeping in mind the optical, mechanical and electronic requirements of visual creators. Making use of our highly accurate design, manufacturing and assembly skills, Fujifilm will continue to develop unique products, and answer the diverse needs of videographers worldwide.

4K
ULTRA HD

HD
HIGH-DEFINITION

FUJINON Lens Model Explanation

Studio/Field Box Lenses

1 2 3 4 5 6 7 8 9
UA 107 x 8.4 B E SM - T 35 K

1	Camera Image Sensor Format	UA	4K-UHD 2/3" Sensor Format
		XA	HD 2/3" Sensor Format
		HA	2/3" Sensor Format
2	Zoom Ratio		
3	Wide End of Focal Length		
4	Bayonet Mount		
5	Extender	E	with Extender
6	Lens Control Type	SM	Servo / Manual Module Interchangeable
		S	Servo Only
		S/T	Field Lens with OS-TECH
7	Lens Type	F	Studio Lens
		D	Minibox Lens
8	Lens Mount	35/48	For Studio Standard Camera Mount (BTA Type)
9	Special Function	E	with 1.2x Extender
		K	with AF

ENG / EFP Portable Lenses

1 2 3 4 5 6 7 8
UXS 20s x 9.5 B E RD - UK ※※

1	ENG / EFP Portable Lens Category	U	UHD Premier Series
		H	High Definition Premier Series
		Z	High Definition Select Series
		X	High Definition eXceed Series
2	Camera Image Sensor Format	A	2/3" Sensor Format
		S	1/2" Sensor Format
		T	1/3" Sensor Format
3	Zoom Ratio		
4	Wide End of Focal Length		
5	Bayonet Mount		
6	Extender	E	with Extender
7	Lens Control Type	RM	Zoom Servo, Focus Manual
		RD	Zoom Servo, Focus Servo
		ZD	Zoom Servo, Focus Servo, with Quick Frame
		MD	Remote Control
8	Drive Unit Type	M	Digital Drive Unit / Zoom Servo, Focus Manual
		S	Digital Drive Unit / Zoom Servo, Focus Servo
		U	Digital Drive Unit / Zoom Servo, Focus Servo, with OS-TECH
		G	Digital Drive Unit / Zoom Servo, Focus Servo, with OS-TECH, Extender Remote
		T	Digital Drive Unit / Zoom Servo, Focus Servo, with Quick Frame
		K	eXceed Drive Unit / Zoom Servo, Focus Manual
		DSD	Remote Control Drive Unit / Video Control (Zoom, Focus, Iris)
		0	without Digital Drive Unit



FUJINON Lens Technology

All large-diameter elements designed for broadcast lenses are the end result of our state of the art optical performance and high quality manufacturing technologies.

HT-EBC Coating (High Transmittance Electron Beam Coating)

HT-EBC (High Transmittance Electron Beam Coating) is the multi layer coating technology developed to enhance the many high performance lens elements used in broadcast lenses. Lenses with HT-EBC boast high transmittance and low reflectivity over a broad wavelength band. Thanks to the coating, flare and ghost are decreased and realizing high edge to edge transmittance.

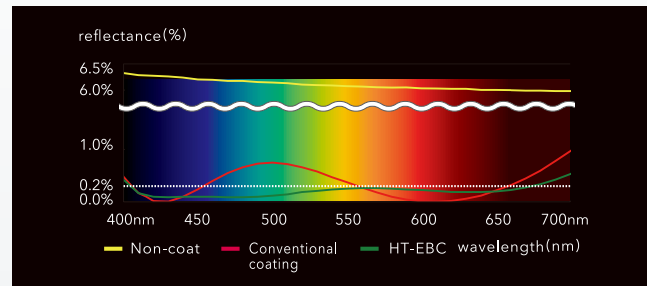

ED-Glass (Extra-Low Dispersion)

By employing ED Glass elements, it is possible to significantly reduce chromatic aberrations. In addition, the reduced chromatic aberration is consistent from the center to the edge producing a superior image with high contrast and sharpness.

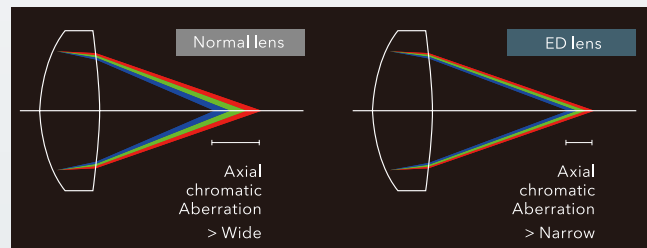

Technology for 8K

Fujifilm has been doing research and development for 8K Super Hi-Vision lenses. The Super Hi-Vision system offers an image beyond ultra high definition with 4,320 scanning lines and 33,000,000 pixels, 16 times that of the High-Vision system. A lens developed for Super Hi-vision must feature extremely high resolution as compared to current lenses. Current 4K High-Vision lenses can not meet the Super Hi-Vision resolution requirement. Thanks not only to our optical design and production technology but also to our latest optical simulation programs and special materials; Fujifilm has been able to achieve 8K optical performance. At the same time, current lens operability is possible by minimizing the lens size and by employing an electronically controlled drive unit. Currently, the 8K Super Hi-Vision lenses being tested under real shooting conditions with plans for their future introduction.



Aspherical Lens

Aspherical lens developed by Fujifilm's own technology will suppress various aberrations such as distortion and spherical aberrations effectively.

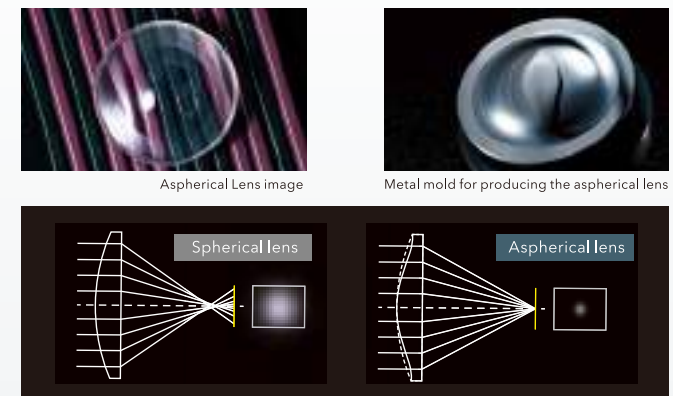

Calcium Fluorite

It equipped fluorite which has high optical performance to broadcast lens. Contribute to suppress chromatic aberrations.

Design Concept

In addition, Fujifilm has employed ergonomic design principles for all operational parts based upon input from talented camera operators. All lenses are also designed to reduce the use of hazardous materials that could pollute the environment. One example is the use of eco-glass, which does not contain toxic substances.

Award of FUJINON Lens

Emmy Award

- 1996 Development of a TV Lens Adapted to CCD
- 2005 Developing High-Performance Lenses Adapted to Hi-Vision
- 2009 Precision Focus Technology
- 2017 Development of cine zoom lenses

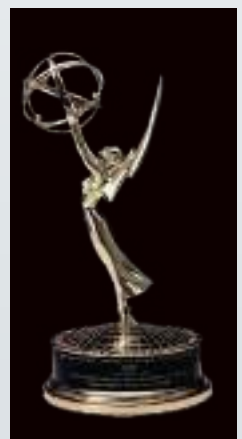

4K Ultra HD 2/3" Lenses for Broadcast -UA Series-

Introducing the New Expanded 4K Broadcast Lens Lineup from FUJINON.

4K demands a higher dimension of performance, and the expanded FUJINON 4K broadcast lens lineup meets the challenge. Extending the limits of "High Resolution", "High Contrast", "Chromatic Aberration Reduction" and "High Dynamic Range", FUJINON's cutting-edge optical technology presents the next standard in optical performance - image quality that exceeds the high expectations of imaging professionals.

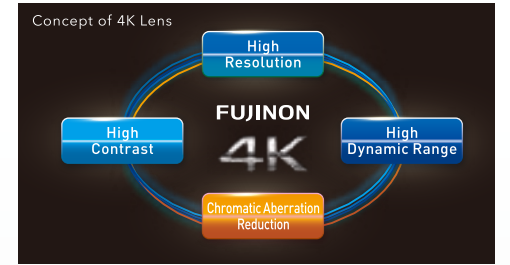

HD	4K	HD	4K	HD	4K	HD	4K
High Resolution		High Contrast		Chromatic Aberration Reduction		High Dynamic Range	

Resolution that matches the ultra-fine pitch of 4K pixels results in crisp and crystal clear images.

Superb image sharpness is achieved by improving MTF even for low-frequency objects that are generally common in the image.

The combination of fluorite ED (extra low dispersion) and super ED lens elements minimizes color fringing and delivers clear, crisp images.

To take full advantage of the expanded dynamic range offered by HDR cameras, we rigorously suppress flare and faithfully transmit the important "blacks" in video image rendering.

Key technology

1. Multi-group zoom system

By employing a multi-group zoom structure, aberrations are suppressed over the entire zoom range from wide angle to telephoto, realizing high image quality.

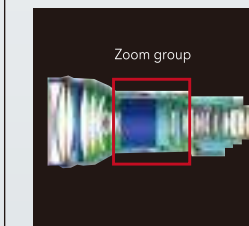

2. Large-aperture aspherical lens

Using a high-precision large-aperture aspherical lens element ensures high MTF to the very edges of the image.

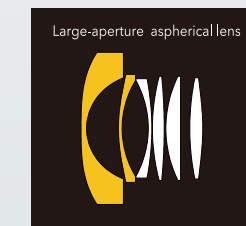

3. Improved surface accuracy

Development of new polishing techniques and improvements in measurement precision achieve surface accuracy more than three times higher than that of HD, contributing to higher image quality.

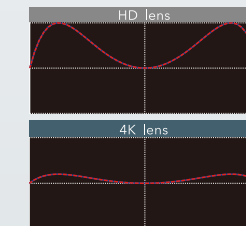

Key technology

4. Development of new barrel design

Optimizing the shape of the lens barrel interior as well as its surface treatment effectively suppresses ghosting and flares.

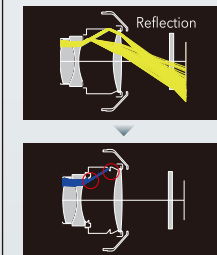

5. New coating system

Adopting HT-EBC coating technology that achieves a low 0.2% reflection or less over a wide spectrum of wavelengths keeps surface reflection of the lens to the absolute minimum and makes it possible to render truer "blacks". In addition, camera adjustment is easier because the transmittance balance is improved from the shortest to the longest visible wavelengths.

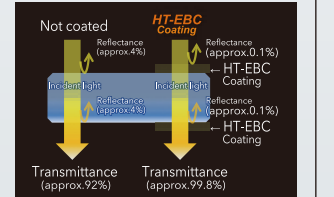

Natural bokeh achieved with nine iris blades

By adopting nine iris blades, FUJINON 4K lenses achieve a nearly circular aperture. This makes it possible to render images taking full advantage of a softer, more natural bokeh.

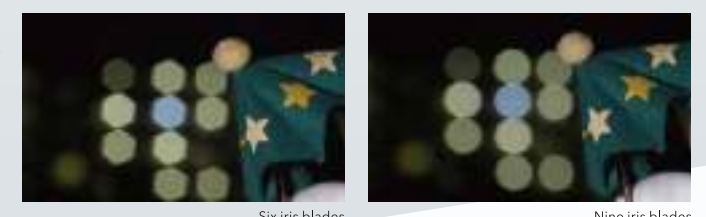

Remote Back Focus (RBF)

RBF enables precise remote control of back focus adjustments via the camera or robotic control panel while viewing a large video monitor in a studio production control room or mobile unit. During set up or if the shooting environment changes due to temperature, etc., the lens can be adjusted remotely at great distances, making more efficient shooting possible.

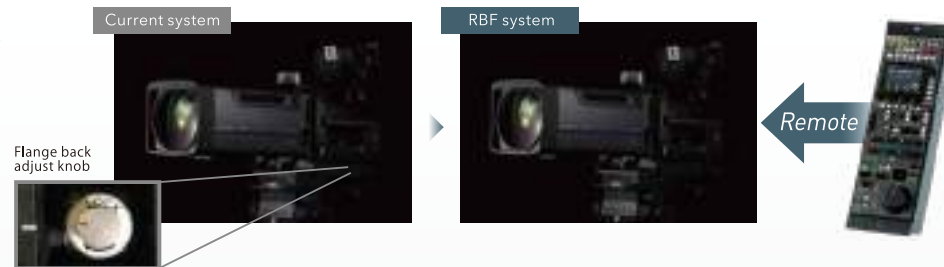

Advanced Focus System

The AF system uses FUJINON's proprietary phase detection system, enabling instant focusing without having to search for focus. This increases accuracy even in situations where focus is difficult to determine in the viewfinder. When shooting video, the operator can concentrate on zooming without worrying about focus control.

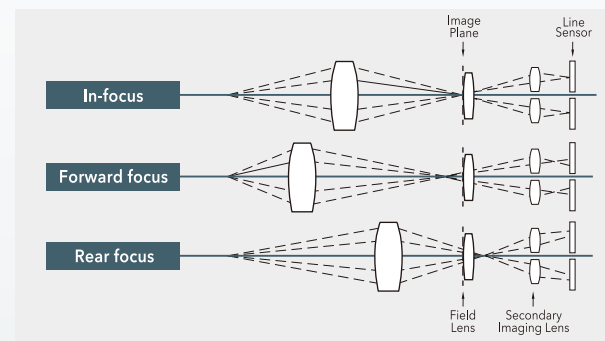

Optical Stabilized Technology OS-TECH

OS-TECH features "The Optical Shift System" where a shift correction signal is generated to optically compensate for vibration according to the amount of the movement detected. This system responds quickly and reduces the phenomenon to a minimum allowing for a natural looking image. The conveniently located control allows the operator to switch the anti-vibration system on and off.

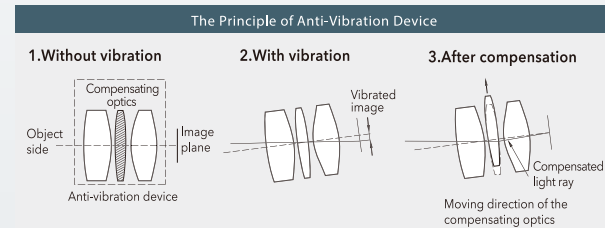

Breathing Compensation Technology(BCT)

Breathing Compensation Technology(BCT) synchronizes zoom movement with the focus movement to automatically correct for changes in the angle of view, thereby minimizing breathing and keeping the image size constant. BCT function eliminates the need to reset the angle of view after focusing, providing a high level of operability.

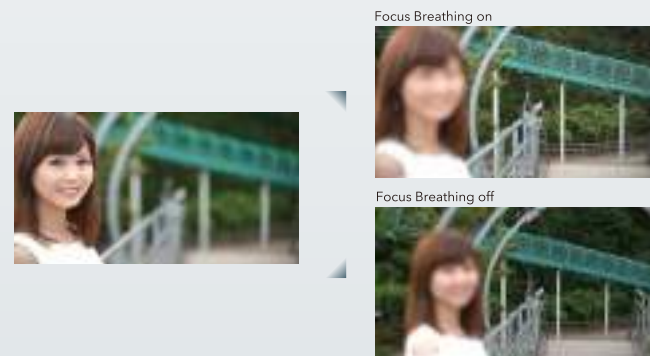

Quick Zoom QuickZoom

Quick Zoom is a function to temporarily zoom to a telephoto position simply by pressing and holding a switch. Releasing the switch returns the lens to its original position. Since it moves at maximum speed from the originating position to the telephoto end, it enables quick focus checks and fine tuning—helpful support for the user during video production.



Macro Function

This system allows macro shooting as close as 0.3m (0.05m on UA27x6.5) from the object. A dedicated Macro Controller helps to create natural bokeh scene effectively.



※Macro Controller (option) enhances shooting.



Macro controller EA-3A-10AB

Zoom/Focus Mode Selection Function

Zoom Mode Selection

The zoom demand makes it possible to select one of three different curves for how zoom speed varies according to the rotation angle of the thumb ring.

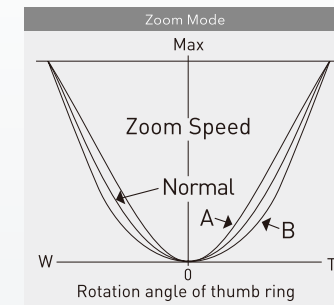

Focus Mode Selection

The focus demand makes it possible to select one of three curves for subject distance depending on the rotation angle of the focus knob. By setting to "Far" (infinity) or "Near" (close-in), it is possible to fine-tune the focus on the infinity side or the near side.

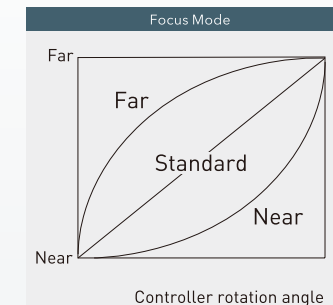

One Shot Preset

Zoom and focus can be preset at a selected position and stored in advance. One touch of the switch during shooting will instantly return to the stored position. This function is convenient when making frequent use of memorized positions during studio shoots or sports broadcasts.

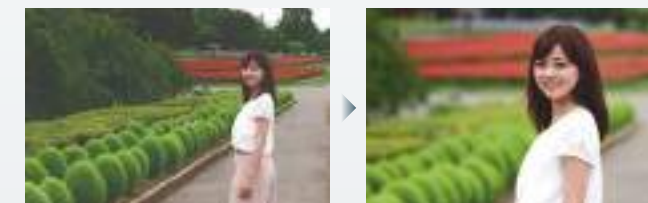

Angle of view and focus can be preset, stored, and reproduced easily

Virtual Connector

The DIGIPOWER drive unit features built-in high resolution 16 bit encoders as standard for highly accurate positioning in virtual studio, robotic and other applications.



Serial Communication Control

Because the drive system is digital, this enables control of zoom, focus, and iris through a serial communication interface on a PC. It also enables read-out of their respective position information, making this digital system an extremely powerful tool in a wide range of operating environments.

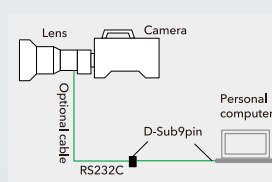

F-Number Hold

When a broadcast TV lens zooms from wide angle to telephoto, F-drop occurs, which causes the open F value to become dark. F-No. Hold limits the zoom position to a point before F-drop begins, making it possible to reduce the workload during video production.

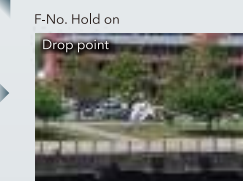
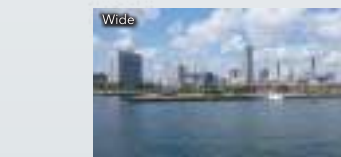
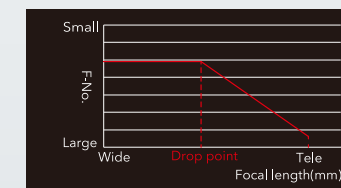

Quick Frame (Optional)

Quick Frame allows for quick manual framing of a shot without the need to select the operation. Adjusting the zoom manually or automatically disengages the servo, which is then automatically re-engaged, when the manual zoom operation is stopped.

Quickframe
For Your Best Shot



2/3" Studio / Field Box Lenses

Horizontal Field of View (16:9)	73	69	62	59	58	56	54	48	3.6	3.1	1.0	0.9	0.8	0.8	0.7	0.6	0.6	0.6
Focal Length (mm) 2/3"	6.5	7	8	8.4	8.7	9	9.5	10.8	154	180	525	610	720	732	832	864	900	1000
UA80x9 1.2xEXT(1x)																		
UA80x9 1.2xEXT(1.2x)																		
UA125x8																		
UA27x6.5																		
UA70x8.7																		
UA107x8.4																		
XA22x7																		
HA27x6.5																		
XA55x9.5																		
XA77x9.5																		
XA99x8.4																		

ENG/EFP Portable Lenses (2/3"4K, 2/3"HD)

Horizontal Field of View (16:9)	94	82	67	64	63	62	59	54	53	45	39	32	10	9.3	8.7	5.5	4.2	4.0	3.4	3.3	3.2	3.1	3.1	2.9	1.9	1.3	1.3	1.3	1.0	0.9		
Focal Length (mm)	4.5	5.5	7.3	7.6	7.8	8	8.5	9.5	9.7	11.5	13.5	16.5	54	59	63	100	130	137	161	167	170	175	176	187	288	410	413	437	570	621		
UA13x4.5																																
UA22x8																																
UA24x7.8																																
UA46x9.5																																
UA46x13.5																																
UA14x4.5																																
UA18x5.5																																
UA18x7.6																																
UA23x7.6																																
HA14x4.5																																
HA18x5.5																																
HA18x7.6																																
HA22x7.3																																
HA23x7.6																																
HA25x11.5																																
HA25x16.5																																
HA42x9.7																																
HA42x13.5																																
ZA12x4.5																																
ZA17x7.6																																
ZA22x7.6																																
XA20sx8.5																																

ENG/EFP Portable Lenses (1/2"HD)

Horizontal Field of View (16:9)	93	65	58	9.3	4.3	3.2
Focal Length (mm)	3.3	5.5	6.3	43	94	126
XS13x3.3						
ZS17x5.5						
XS20sx6.3						

ENG/EFP Portable Lenses (1/3"HD)

Horizontal Field of View (16:9)	64	60	58	3.9	3.9	3.2
Focal Length (mm)	4.2	4.5	4.7	76	77	94
HTs18x4.2						
XT17sx4.5						
XT20sx4.7						

4K Plus Premier Series

Flagship series with surpassing 4K optical performance



Model Name	UA80x9BESM 1.2x EXT	UA125x8BESM
Focal Length (1x)/(1.2x)/(2x)	9-720mm/10.8-864mm/18-1440mm	8-1000mm /- 16-2000mm
Zoom Ratio	80 x	125x
Extender	1.2 x 2 x	2 x
Maximum Relative Aperture (F-No.)	1:1.7 (9-350mm) 1:3.5 (720mm)	1:1.7(8-340mm) 1:5.0(1000mm)
Minimum Object Distance (M.O.D.) from Front Lens	3.7m	3.0m
Object Dimensions at M.O.D. 16:9 Aspect Ratio	(1x) 9mm 3501mm x 1968mm 720mm 46mm x 26mm (1.2x) 10.8mm 3009mm x 1692mm 864mm 39mm x 22mm (2x) 18mm 1816mm x 1021mm 1440mm 23mm x 13mm	(1x) 8mm 3198mm x 1799mm 1000mm 27mm x 15mm (2x) 16mm 1677mm x 943mm 2000mm 14mm x 8mm
Angular Field of View 16:9 Aspect Ratio	(1x) 9mm 56.1° x 33.3° 720mm 0.8° x 0.4° (1.2x) 10.8mm 47.9° x 28.0° 864mm 0.6° x 0.4° (2x) 18mm 29.8° x 17.0° 1440mm 0.4° x 0.2°	(1x) 8mm 61.9° x 37.2° 1000mm 0.55° x 0.31° (2x) 16mm 33.4° x 19.1° 2000mm 0.27° x 0.15°
Approx. Size	258 x 264 x 610mm(HxWxL)	258 x 264 x 635mm(HxWxL)
Approx. Mass	23.5kg	26.6kg

4K Premier Series

Excellent 4K optical performance for versatile shooting scene



Model Name	UA27x6.5BESM	UA70x8.7BESM
Focal Length (1x)/(2x)	6.5-180mm / 13-360mm	8.7mm-610mm / 17.4mm-1220mm
Zoom Ratio	27 x	70 x
Extender	2 x	2 x
Maximum Relative Aperture (F-No.)	1:1.5(6.5-123mm) 1:2.2(180mm)	1:1.7(8.7-340mm) 1:3.05(610mm)
Minimum Object Distance (M.O.D.) from Front Lens	0.6m	3.05m
Object Dimensions at M.O.D. 16:9 Aspect Ratio	(1x) 6.5mm 1063 x 597mm 180mm 38 x 21mm (2x) 13mm 529 x 297mm 360mm 20 x 11mm	(1x) 8.7mm 2935mmx1651mm 610mm 44mmx25mm (2x) 17.4mm 1537mmx865mm 1220mm 23mmx13mm
Angular Field of View 16:9 Aspect Ratio	(1x) 6.5mm 72.8° x 45.0° 180mm 3.1° x 1.7° (2x) 13mm 40.5° x 23.4° 360mm 1.5° x 0.9°	(1x) 8.7mm 57.7°x34.4° 610mm 0.9°x0.5° (2x) 17.4mm 30.8°x17.6° 1220mm 0.5°x0.3°
Approx. Size	258 x 264 x 536mm(HxWxL)	258x264x610mm(HxWxL)
Approx. Mass	22.8kg	23.8kg



Model Name	UA107x8.4BESM	UA107x8.4BESM AF
Focal Length (1x)/(2x)	8.4-900mm / 16.8-1800mm	8.4-900mm / 16.8-1800mm
Zoom Ratio	107 x	107 x
Extender	2 x	2 x
Maximum Relative Aperture (F-No.)	1:1.7 (8.4-340mm) 1:4.5 (900mm)	1:1.7(8.4-340mm) 1:4.5(900mm)
Minimum Object Distance (M.O.D.) from Front Lens	3.05m	3.05m
Object Dimensions at M.O.D. 16:9 Aspect Ratio	(1x) 8.4mm 3053mm x 1717mm 900mm 30mm x 17mm (2x) 16.8mm 1594mm x 896mm 1800mm 15mm x 9mm	(1x) 8.4mm 3052mm x 1717mm 900mm 30mm x 17mm (2x) 16.8mm 1594mm x 896mm 1800mm 15mm x 9mm
Angular Field of View 16:9 Aspect Ratio	(1x) 8.4mm 59.4° x 35.6° 900mm 0.6° x 0.3° (2x) 16.8mm 31.9° x 18.2° 1800mm 0.3° x 0.2°	(1x) 8.4mm 59.4°x35.6° 900mm 0.6°x0.3° (2x) 16.8mm 31.9°x 18.2° 1800mm 0.3°x 0.2°
Approx. Size	258 x 264 x 610mm(HxWxL)	258 x 264 x 670mm(HxWxL)
Approx. Mass	23.9kg	26.0kg



Studio / Field Box Lenses

HD HIGH-DEFINITION **2/3"**



MINIBOX



Model Name	XA22x7BES				HA27x6.5BESM			
Focal Length (1x)/(2x)	7-154mm / 14-308mm				6.5-180mm / 13-360mm			
Zoom Ratio	22 x				27 x			
Extender	2 x				2 x			
Maximum Relative Aperture (F-No.)	1 : 1.8(7-116mm) 1 : 2.4(154mm)				1 : 1.5(6.5-123mm) 1 : 2.2(180mm)			
Minimum Object Distance (M.O.D.) from Front Lens	0.8m				0.6m			
Object Dimensions at M.O.D. 16:9 Aspect Ratio	(1x)	1197 x 673mm		(2x)	599 x 337mm			
	7mm	54 x 31mm	14mm	308mm	27 x 15mm	13mm	527 x 296mm	360mm
Angular Field of View 16:9 Aspect Ratio	(1x)	68.8° x 42.1°		(2x)	37.8° x 21.8°			
	7mm	3.6° x 2°	14mm	308mm	1.8° x 1°	13mm	40.5° x 23.4°	360mm
Approx. Size	179 x 187 x 340mm(HxWxL)				233 x 231 x 539mm(HxWxL)			
Approx. Mass	6.6kg				22.3kg			

HD HIGH-DEFINITION **2/3"**



Model Name	XA55x9.5BESM				XA77x9.5BESM			
Focal Length (1x)/(2x)	9.5-525mm / 19-1050mm				9.5-732mm / 19.0-1464mm			
Zoom Ratio	55 x				77 x			
Extender	2 x				2 x			
Maximum Relative Aperture (F-No.)	1:1.7(9.5mm-308mm) 1:2.9(525mm)				1 : 1.7(9.5-335mm) 1 : 3.8(732mm)			
Minimum Object Distance (M.O.D.) from Front Lens	3.0m				2.7m			
Object Dimensions at M.O.D. 16:9 Aspect Ratio	(1x)	2782 x 1564mm		(2x)	1406 x 790mm			
	9.5mm	51 x 29mm	19mm	1050mm	26 x 15mm	19.0mm	1241 x 697mm	1464mm
Angular Field of View 16:9 Aspect Ratio	(1x)	53.6° x 31.7°		(2x)	28.3° x 16.1°			
	9.5mm	1° x 0.6°	19mm	1050mm	0.5° x 0.3°	9.5mm	53.6° x 31.7°	18.6mm
Approx. Size	253 x 253 x 876mm(HxWxL)				253 x 253 x 656.4mm(HxWxL)			
Approx. Mass	24.8kg				22.4kg			

*XA55x9.5BESM without lens supporter model is also available.



HD HIGH-DEFINITION **2/3"**

Model Name	XA99x8.4BESM							
Focal Length (1x)/(2x)	8.4-832mm / 16.8-1664mm							
Zoom Ratio	99 x							
Extender	2 x							
Maximum Relative Aperture (F-No.)	1 : 1.7(8.4-341mm) 1 : 4.15(832mm)							
Minimum Object Distance (M.O.D.) from Front Lens	2.95m							
Object Dimensions at M.O.D. 16:9 Aspect Ratio	(1x)	2950 x 1658mm		(2x)	1538 x 864mm			
	8.4mm	31 x 17mm	16.8mm	1664mm	16 x 9mm	8.4mm	59.4° x 35.6°	16.8mm
Angular Field of View 16:9 Aspect Ratio	(1x)	59.4° x 35.6°		(2x)	31.9° x 18.2°			
	8.4mm	0.7° x 0.4°	16.8mm	1664mm	0.3° x 0.2°	8.4mm	59.4° x 35.6°	16.8mm
Approx. Size	258 x 264 x 610mm(HxWxL)							
Approx. Mass	23.5kg							

Studio/Field Lens System Configuration

SS-21DB

Servo Focus / Servo Zoom

DIGIPOWER

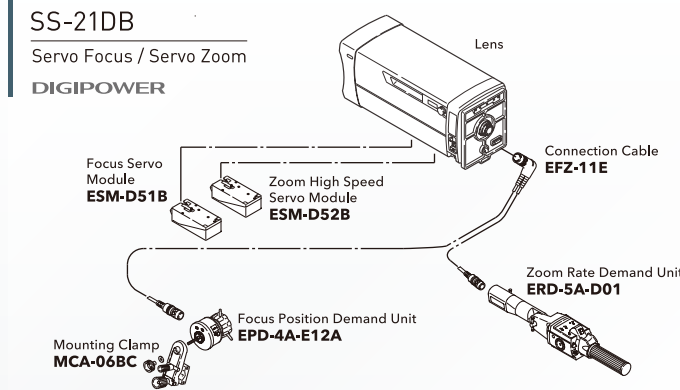

MS-31D

Manual Focus / Servo Zoom

DIGIPOWER

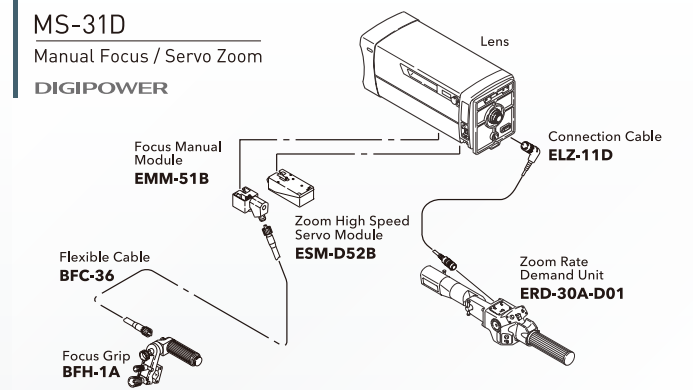

SS-31D

Servo Focus / Servo Zoom

DIGIPOWER

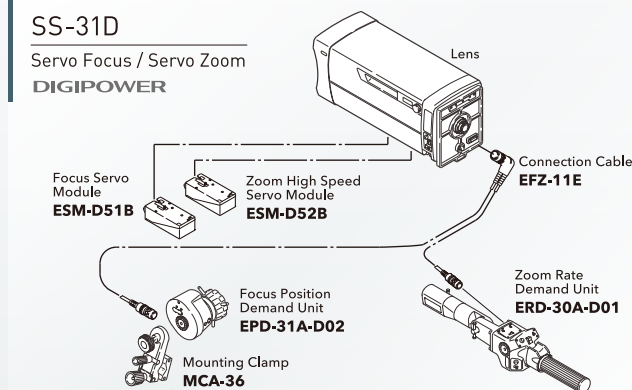

SS-MB (Minibox Studio Lens)

Servo Focus / Servo Zoom

The lens supporter is required.

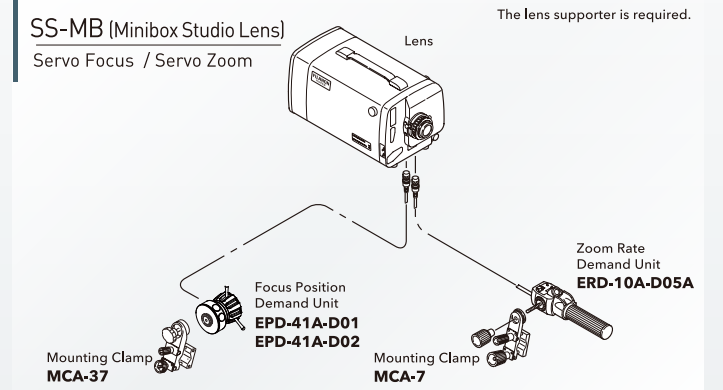

Control Accessories List

Lens Focus/Zoom Drive Unit	Servo Digital	Description	Model Name
	Servo Digital	Zoom High Speed Module	ESM-D52B/D53B
	Manual	Manual Focus/Zoom Module	ESM-D51B
Focus	Servo Digital	Focus Position Demand Unit	EPD-51A-F02
	Manual	Focus Position Demand Unit	EPD-31A-D02
	Manual	Mounting Clamp for EPD-31A-D01	MCA-36
	Manual	Mounting Clamp for EPD-51A-F02	MCA-51
	Manual	Focus Position Demand Unit	EPD-4A-E12A
	Manual	AF Focus Position Demand Unit	EPD-4A-S13F
	Manual	Mounting Clamp	MCA-06BC
Zoom	Servo Digital	Servo Focus Grip	EPA-22
	Manual	Manual Focus Grip	BFH-1A
Other	Servo Digital	Zoom Rate Demand Unit	ERD-30A-D01
	Servo Digital	Zoom Rate Demand Unit	ERD-5A-D01
	Manual	Zoom Manual Handle (For HD) Only	BZH-2A
Other	Manual	Connection Cable (Y Cable for Full-Servo Kit)	EFZ-11E
	Manual	Connection Cable (Cable for Semi-Servo Kit)	ELZ-11D
	Manual	Flexible Cable	BFC-36
	Manual	Range Selector	ERS-51B
	Manual	Macro Remote Controller	EA-3A-10AB
	Manual	OS-TECH Controller	EA-12A-05BD
	Manual	PC Connection Cable	SA-206D-005
	Manual	Lens Supporter (For BTA Mount)	ELH-112A-35A*
	Manual	Protection Glass (UA27)	EPF-196A
	Manual	Protection Glass (UA70,80,107)	EPF-226C

*An external power supply is required when you use a supporter (ELH-112A-35A)

Control Accessories for XA22x7BES (Minibox)

	Description	Model Name
Focus	Focus Position Demand Unit	EPD-41A-D01/D02
	Mounting Clamp	MCA-37
Zoom	Zoom Demand (Featured x2 Extender Remote)	ERD-10A-D05A
	Mounting Clamp	MCA-7
Other	Lens Supporter	ALH-117C-02A

SS-21DB AF

Servo Focus / Servo Zoom

DIGIPOWER

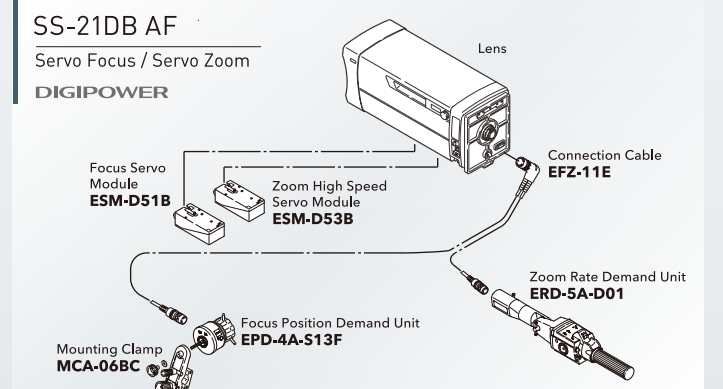

4K Plus Premier Series

Flagship series with surpassing 4K optical performance



Model Name	UA13x4.5BERD		UA22x8BERD	
Focal Length (1x)/(2x)	4.5-59mm / 9-118mm		8.0-176mm / 16-352mm	
Zoom Ratio	13 x		22 x	
Extender	2 x		2 x	
Maximum Relative Aperture (F-No.)	1:1.8 (4.5-41mm) 1:2.6 (59mm)		1:1.8 (8-124mm) 1:2.55 (176mm)	
Minimum Object Distance (M.O.D.) from Front Lens	0.3m		0.85m	
Object Dimensions at M.O.D. 16:9 Aspect Ratio	(1x) 4.5mm 744mm x 418mm 59mm 54mm x 30mm	(2x) 9mm 367mm x 206mm 118mm 28mm x 16mm	(1x) 8mm 905mm x 509mm 176mm 43mm x 24mm	(2x) 16mm 472mm x 265mm 352mm 22mm x 12mm
Angular Field of View 16:9 Aspect Ratio	(1x) 4.5mm 93.6° x 61.8° 59mm 9.3° x 5.2°	(2x) 9mm 56.1° x 33.3° 118mm 4.7° x 2.6°	(1x) 8mm 61.9° x 37.2° 176mm 3.1° x 1.8°	(2x) 16mm 33.4° x 19.1° 352mm 1.6° x 0.9°
Filter Thread	M127 x 0.75 (Filter attaches to the lens hood)		M110 x 0.75 (Filter attaches to the lens hood)	
Approx. Size	Ø95 x 253mm (ØxLength)		Ø110 x 241.5mm (ØxLength)	
Approx. Mass	2.28kg (without lens hood)		2.55kg (without lens hood)	



Model Name	UA24x7.8BERD		UA46x9.5BERD		UA46x13.5BERD	
Focal Length (1x)/(2x)	7.8-187mm / 15.6-374mm		9.5mm-437mm / 19-874mm		13.5mm-621mm / 27-1242mm	
Zoom Ratio	24 x		46 x		46 x	
Extender	2 x		2 x		2 x	
Maximum Relative Aperture (F-No.)	1:1.8(7.8-118mm) 1:2.85(187mm)		1:2.0(9.5mm-224mm) 1:3.9(437mm)		1:2.8(13.5mm-316mm) 1:5.5(621mm)	
Minimum Object Distance (M.O.D.) from Front Lens	0.8m		2.8m		2.8m	
Object Dimensions at M.O.D. 16:9 Aspect Ratio	(1x) 7.8mm 883mm x 496mm 187mm 38mm x 21mm	(2x) 15.6mm 459mm x 258mm 374mm 20mm x 11mm	(1x) 9.5mm 2653mmx1491mm 437mm 59mmx33mm	(2x) 19mm 1331x748mm 874mm 30x17mm	(1x) 13.5mm 1886mmx1060mm 621mm 42mmx24mm	(2x) 27mm 936mmx526mm 1242mm 21mmx12mm
Angular Field of View 16:9 Aspect Ratio	(1x) 7.8mm 63.2° x 38.1° 187mm 2.9° x 1.7°	(2x) 15.6mm 34.2° x 19.6° 374mm 1.5° x 0.8°	(1x) 9.5mm 53.6°x31.7° 437mm 1.3°x0.7°	(2x) 19mm 28.3°x16.1° 874mm 0.6°x0.4°	(1x) 13.5mm 39.1°x22.6° 621mm 0.9°x0.5°	(2x) 27mm 20.1°x11.4° 1242mm 0.4°x0.2°
Filter Thread	M95 x 1 / M107 x 1 (Filter attaches to the lens hood)		M127 x 0.75		M127 x 0.75	
Approx. Size	Ø100 x 220.5mm (ØxLength)		Ø146.5 x 345.8(ØxLength)		Ø146.5 x 364.2(ØxLength)	
Approx. Mass	1.98kg (without lens hood)		5.7kg(without lens hood)		5.8kg(without lens hood)	

4K Premier Series

Excellent 4K optical performance for versatile shooting scene



Model Name	UA14x4.5BERD		UA18x5.5BERD	
Focal Length (1x)/(2x)	4.5-63mm / 9-126mm		5.5-100mm / 11-200mm	
Zoom Ratio	14 x		18 x	
Extender	2 x		2 x	
Maximum Relative Aperture (F-No.)	1:1.8 (4.5-41mm) 1:2.8(63mm)		1:1.8(5.5-62mm) 1:2.9(100mm)	
Minimum Object Distance (M.O.D.) from Front Lens	0.3m		0.4m	
Object Dimensions at M.O.D. 16:9 Aspect Ratio	(1x) 4.5mm 744mm x 418mm 63mm 51mm x 29mm	(2x) 9mm 365mm x 205mm 126mm 27mm x 15mm	(1x) 5.5mm 800mm x 450mm 100mm 44mm x 25mm	(2x) 11mm 395mm x 222mm 200mm 22mm x 12mm
Angular Field of View 16:9 Aspect Ratio	(1x) 4.5mm 93.6° x 61.8° 63mm 8.7° x 4.9°	(2x) 9mm 56.1° x 33.3° 126mm 4.4° x 2.5°	(1x) 5.5mm 82.2° x 52.2° 100mm 5.5° x 3.1°	(2x) 11mm 47.1° x 27.5° 200mm 2.7° x 1.5°
Filter Thread	M127 x 0.75 (Filter attaches to the lens hood)		M127 x 0.75 (Filter attaches to the lens hood)	
Approx. Size	Ø95 x 238.5mm (ØxLength)		Ø95 x 240.5mm (ØxLength)	
Approx. Mass	2.21kg (without lens hood)		2.04kg (without lens hood)	



Model Name	UA18x7.6BERD		UA23x7.6BERD	
Focal Length (1x)/(2x)	7.6-137mm / 15.2-274mm		7.6-175mm / 15.2-350mm	
Zoom Ratio	18x		23x	
Extender	2 x		2 x	
Maximum Relative Aperture (F-No.)	1:1.8(7.6-102mm) 1:2.4(137mm)		1:1.8(7.6-119mm) 1:2.65(175mm)	
Minimum Object Distance (M.O.D.) from Front Lens	0.6m		0.8m	
Object Dimensions at M.O.D. 16:9 Aspect Ratio	(1x) 7.6mm 696mm x 392mm 137mm 41mm x 23mm	(2x) 15.2mm 362mm x 204mm 274mm 21mm x 12mm	(1x) 7.6mm 915mm x 514mm 175mm 41mm x 23mm	(2x) 15.2mm 473mm x 266mm 350mm 21mm x 12mm
Angular Field of View 16:9 Aspect Ratio	(1x) 7.6mm 64.5°x39° 137mm 4°x2.3°	(2x) 15.2mm 35°x20.1° 274mm 2°x1.1°	(1x) 7.6mm 64.5°x39° 175mm 3.1°x1.8°	(2x) 15.2mm 35°x20.1° 350mm 1.6°x0.9°
Filter Thread	M82x0.75		M95x1 / M107x1(Filter attaches to lens hood)	
Approx. Size	Ø85x204mm(ØxLength)		Ø100x221.4mm(ØxLength)	
Approx. Mass	1.74kg (without lens hood)		1.95kg (without lens hood)	

ENG / EFP Portable Lenses

Premier Series

Premier Series lenses are designed to complement and enhance the quality of HDTV systems. Great consideration in the design and development of these high-end HD lenses has been taken to incorporate the highest optical and mechanical specifications while ensuring unmatched performance in the most rugged and demanding of production environments.



Model Name	HA14x4.5BERM / BERD	HA18x5.5BERM / BERD	HA18x7.6BERM / BERD
Focal Length (1x)/(2x)/(2.2x)	4.5-63mm / 9.9-139mm	5.5-100mm / 11-200mm /-	7.6-137mm / 15.2-274mm /-
Zoom Ratio	14 x	18 x	18 x
Extender	2.2 x	2 x	2 x
Maximum Relative Aperture (F-No.)	1 : 1.8 (4.5-41mm) 1 : 2.8 (63mm)	1:1.8(5.5mm-62mm) 1:2.9(100mm)	1 : 1.8 (7.6-103mm) 1 : 2.4 (137mm)
Minimum Object Distance (M.O.D.) from Front Lens	0.3m	0.4m	0.6m
Object Dimensions at M.O.D. 16:9 Aspect Ratio	(1x) 4.5mm 744 x 418mm 63mm 51 x 29mm (2.2x) 9.9mm 330 x 185mm 139mm 24 x 13mm	(1x) 5.5mm 800 x 450mm 100mm 44 x 25mm (2x) 11mm 395 x 222mm 200mm 22 x 12mm	(1x) 7.6mm 696 x 392mm 137mm 41 x 23mm (2x) 15.2mm 362 x 204mm 274mm 21 x 12mm
Angular Field of View 16:9 Aspect Ratio	(1x) 4.5mm 93.6° x 61.8° 63mm 8.7° x 4.9° (2.2x) 9.9mm 51.7° x 30.5° 139mm 4° x 2.2°	(1x) 5.5mm 82.2° x 52.2° 100mm 5.5° x 3.1° (2x) 11mm 47.1° x 27.5° 200mm 2.7° x 1.5°	(1x) 7.6mm 64.5° x 39° 137mm 4° x 2.3° (2x) 15.2mm 35° x 20.1° 274mm 2° x 1.1°
Filter Thread	M127 x 0.75 (Filter attaches to the lens hood.)	M127 x 0.75 (Filter attaches to the lens hood)	M82 x 0.75
Approx. Size	Ø95 x 238.5mm(ØxLength)	Ø95 x 240.5mm(ØxLength)	Ø85 x 204mm(ØxLength)
Approx. Mas	2.18kg(RM) / 2.26kg(RD) (without lens hood)	1.97kg(RM) / 2.04kg(RD) (without lens hood)	1.62kg(RM) / 1.69kg(RD) (without lens hood)



Model Name	HA22x7.3BERD	HA23x7.6BERM / BERD	HA25x11.5BERD
Focal Length (1x)/(2x)	7.3-161mm / 14.6-322mm	7.6-175mm / 15.2-350mm	11.5-288mm / 23-576mm
Zoom Ratio	22 x	23 x	25 x
Extender	2 x	2 x	2 x
Maximum Relative Aperture (F-No.)	1 : 1.9(7.3-113mm) 1 : 2.7(161mm)	1 : 1.8 (7.6-119mm) 1 : 2.65 (175mm)	1 : 2 (11.5-206mm) 1 : 2.8 (288mm)
Minimum Object Distance (M.O.D.) from Front Lens	0.85m	0.8m	2.2m
Object Dimensions at M.O.D. 16:9 Aspect Ratio	(1x) 7.3mm 1222 x 687mm 161mm 55 x 31mm (2x) 14.6mm 609 x 342mm 322mm 28 x 16mm	(1x) 7.6mm 915 x 514mm 175mm 41 x 23mm (2x) 15.2mm 473 x 266mm 350mm 21 x 12mm	(1x) 11.5mm 1740 x 978mm 288mm 70 x 39mm (2x) 23mm 870 x 489mm 576mm 35 x 20mm
Angular Field of View 16:9 Aspect Ratio	(1x) 7.3mm 66.6° x 40.5° 161mm 3.4° x 1.9° (2x) 14.6mm 36.4° x 20.9° 322mm 1.7° x 1°	(1x) 7.6mm 64.5° x 39° 175mm 3.1° x 1.8° (2x) 15.2mm 35° x 20.1° 350mm 1.6° x 0.9°	(1x) 11.5mm 45.3° x 26.4° 288mm 1.9° x 1.1° (2x) 23mm 23.6° x 13.4° 576mm 1° x 0.5°
Filter Thread	M127 x 0.75 (Filter attaches to the lens hood.)	M95 x 1 / M107 x 1 (Filter attaches to the lens hood.)	M107 x 1 / M127 x 0.75 (Filter attaches to the lens hood.)
Approx. Size	Ø110 x 287.3mm(ØxLength)	Ø100 x 221.4mm(ØxLength)	Ø110 x 265mm(ØxLength)
Approx. Mass	3.22kg(RD) (without lens hood)	1.88kg(RM) / 1.95kg(RD) (without lens hood)	2.81kg (without lens hood)



Model Name	HA25x16.5BERD	HA42x9.7BERD	HA42x13.5BERD
Focal Length (1x)/(2x)	16.5-413mm / 33-826mm	9.7-410mm / 19.4-820mm	13.5-570mm / 27-1140mm
Zoom Ratio	25 x	42 x	42 x
Extender	2 x	2 x	2 x
Maximum Relative Aperture (F-No.)	1 : 2.8 (16.5-289mm) 1 : 4 (413mm)	1 : 2.9(7-225mm) 1 : 3.7 (410mm)	1 : 2.8 (13.5-307mm) 1 : 5.2 (570mm)
Minimum Object Distance (M.O.D.) from Front Lens	2.2m	2.8m	2.8m
Object Dimensions at M.O.D. 16:9 Aspect Ratio	(1x) 16.5mm 1213 x 682mm 413mm 49 x 27mm (2x) 33mm 606 x 341mm 826mm 24 x 14mm	(1x) 9.7mm 2619 x 1472mm 410mm 64 x 36mm (2x) 19.4mm 1339 x 753mm 820mm 33 x 19mm	(1x) 13.5mm 1888 x 1061mm 570mm 45 x 25mm (2x) 27mm 944 x 530mm 1140mm 22 x 13mm
Angular Field of View 16:9 Aspect Ratio	(1x) 16.5mm 32.4° x 18.6° 413mm 1.3° x 0.7° (2x) 33mm 16.5° x 9.3° 826mm 0.7° x 0.4°	(1x) 9.7mm 52.6° x 31.1° 410mm 1.3° x 0.8° (2x) 19.4mm 27.8° x 15.8° 820mm 0.7° x 0.4°	(1x) 13.5mm 39.1° x 22.6° 570mm 1° x 0.5° (2x) 27mm 20.1° x 11.4° 1140mm 0.5° x 0.3°
Filter Thread	M107 x 1 / M127 x 0.75 (Filter attaches to the lens hood.)	M127 x 0.75	M127 x 0.75
Approx. Size	Ø110 x 278mm(ØxLength)	Ø130 x 338.5mm(ØxLength)	Ø130 x 357.5mm(ØxLength)
Approx. Mass	2.9kg (without lens hood)	5.3kg (without lens hood)	5.4kg (without lens hood)

SELECT Series

Select Series lenses are designed to meet the high performance needs of the next generation of cost-effective high performance HD camera systems. Fujifilm's unique Select Series concept for HDTV lenses was directly derived from our high-end Premier Series technology.



Model Name	ZA12x4.5BERM / BERD	ZA17x7.6BERM / BERD	ZA22x7.6BERM / BERD
Focal Length (1x)/(2x)	4.5-54mm / 9-108mm	7.6-130mm / 15.2-260mm	7.6-167mm / 15.2-334mm
Zoom Ratio	12 x	17 x	22 x
Extender	2 x	2 x	2 x
Maximum Relative Aperture (F-No.)	1 : 1.8 (4.5-41mm) 1 : 2.4 (54mm)	1 : 1.8 (7.6-102mm) 1 : 2.3 (130mm)	1 : 1.8 (7.6-120mm) 1 : 2.5 (167mm)
Minimum Object Distance (M.O.D.) from Front Lens	0.3m	0.6m	0.8m
Object Dimensions at M.O.D. 16:9 Aspect Ratio	(1x) 4.5mm 757 x 425mm 54mm 59 x 33mm (2x) 9mm 373 x 210mm 108mm 31 x 17mm	(1x) 7.6mm 696 x 392mm 130mm 43 x 24mm (2x) 15.2mm 362 x 204mm 260mm 22 x 12mm	(1x) 7.6mm 915 x 514mm 167mm 43 x 24mm (2x) 15.2mm 473 x 266mm 334mm 22 x 12mm
Angular Field of View 16:9 Aspect Ratio	(1x) 4.5mm 93.6° x 61.8° 54mm 10.1° x 5.7° (2x) 9mm 56.1° x 33.3° 108mm 5.1° x 2.9°	(1x) 7.6mm 64.5° x 39° 130mm 4.2° x 2.4° (2x) 15.2mm 35° x 20.1° 260mm 2.1° x 1.2°	(1x) 7.6mm 64.5° x 39° 167mm 3.3° x 1.8° (2x) 15.2mm 35° x 20.1° 334mm 1.6° x 0.9°
Filter Thread	M127 x 0.75 (Filter attaches to the lens hood.)	M82 x 0.75	M95 x 1 / M107 x 1 (Filter attaches to the lens hood.)
Approx. Size	Ø95 x 237.5mm(ØxLength)	Ø85 x 203mm(ØxLength)	Ø100 x 220.4mm(ØxLength)
Approx. Mass	2.0kg (RM) / 2.07kg (RD) (without lens hood)	1.67kg (RM) / 1.74kg (RD) (without lens hood)	1.85kg (RM) / 1.92kg (RD) (without lens hood)

*BRM/BRD type are also available. For more information, please contact nearest our FUJIFILM office.

eXceed Series

eXceed series lenses are designed to compliment a new generation of cost-effective HD camera systems, extracting the most performance with the greatest value.



Model Name	XA20s x 8.5BRM	XA20s x 8.5BERM
Focal Length (1x)/(2x)	8.5-170mm/-	8.5-170mm / 17-340mm
Zoom Ratio	20 x	20 x
Extender	-	2 x
Maximum Relative Aperture (F-No.)	1 : 1.8 (8.5-113mm) 1 : 2.7 (170mm)	1 : 1.8 (8.5-113mm) 1 : 2.7 (170mm)
Minimum Object Distance (M.O.D.) from Front Lens	0.9m	0.9m
Object Dimensions at M.O.D. 16:9 Aspect Ratio	(1x) 8.5mm 910 x 511mm 170mm 47 x 26mm (2x) -	(1x) 8.5mm 910 x 511mm 170mm 47 x 26mm (2x) 17mm 469 x 264mm 340mm 24 x 13mm
Angular Field of View 16:9 Aspect Ratio	(1x) 8.5mm 58.9° x 35.2° 170mm 3.2° x 1.8° (2x) -	(1x) 8.5mm 58.9° x 35.2° 170mm 3.2° x 1.8° (2x) 17mm 31.5° x 18° 340mm 1.6° x 0.9°
Filter Thread	M82 x 0.75	M82 x 0.75
Approx. Size	Ø85 x 180.8mm(ØxLength)	Ø85 x 200.8mm(ØxLength)
Approx. Mass	1.5kg (without lens hood)	1.6kg (without lens hood)

1/2" Series

SELECT Series



Model Name	XS13x3.3BRM	ZS17x5.5BERM	XS20s x 6.3BRM
Focal Length (1x)/(2x)	3.3-43mm /-	5.5-94mm / 11-188mm	6.3-126mm /-
Zoom Ratio	13 x	17 x	20 x
Extender	-	2 x	-
Maximum Relative Aperture (F-No.)	1 : 1.4 (3.3-32mm) 1 : 1.9 (43mm)	1 : 1.4 (5.5-77mm) 1 : 1.7 (94mm)	1 : 1.4 (6.3-88mm) 1 : 2.0 (126mm)
Minimum Object Distance (M.O.D.) from Front Lens	0.3m	0.6m	0.9m
Object Dimensions at M.O.D. 16:9 Aspect Ratio	(1x) 3.3mm 752 x 423mm 43mm 54 x 30mm (2x) -	(1x) 5.5mm 698 x 399mm 94mm 42 x 24mm (2x) 11mm 363 x 204mm 188mm 22 x 12mm	(1x) 6.3mm 904 x 508mm 126mm 47 x 26mm (2x) -
Angular Field of View 16:9 Aspect Ratio	(1x) 3.3mm 93.1° x 61.4° 43mm 9.3° x 5.2° (2x) -	(1x) 5.5mm 64.7° x 39.2° 94mm 4.3° x 2.4° (2x) 11mm 35.2° x 20.2° 188mm 2.1° x 1.2°	(1x) 6.3mm 57.9° x 34.6° 126mm 3.2° x 1.8° (2x) -
Filter Thread	M127 x 0.75 (Filter attaches to the lens hood.)	M82 x 0.75	M82 x 0.75
Approx. Size	Ø95 x 240.5mm(ØxLength)	Ø85 x 206.6mm(ØxLength)	Ø85 x 181.9mm(ØxLength)
Approx. Mass	1.93kg (without lens hood)	1.67kg (without lens hood)	1.4kg (RM) (without lens hood)

1/3" Series

PREMIER Series

eXceed Series



Model Name	HTs18x4.2BERM	XT17sx4.5BRM	XT20sx4.7BRM
Focal Length (1x)/(2x)	4.2–76mm / 8.4–152mm	4.5–77mm / -	4.7–94mm / -
Zoom Ratio	18 x	17 x	20 x
Extender	2 x	-	-
Maximum Relative Aperture (F-No.)	1 : 1.4 (4.2–76mm) 1 : 2.8 (8.4–152mm)	1 : 1.6 (4.5–77mm)	1 : 1.4 (4.7–88mm) 1 : 1.5 (94mm)
Minimum Object Distance (M.O.D.) from Front Lens	0.6m	0.95m	0.9m
Object Dimensions at M.O.D. 16:9 Aspect Ratio	(1x) 4.2mm 697 x 392mm 76mm 41 x 23mm (2x) 8.4mm 360 x 202mm 152mm 21 x 12mm	(1x) 4.5mm 999 x 562mm 77mm 60 x 34mm (2x) -	(1x) 4.7mm 901 x 506mm 94mm 47 x 26mm (2x) -
Angular Field of View 16:9 Aspect Ratio	(1x) 4.2mm 63.8° x 38.6° 76mm 3.9° x 2.2° (2x) 8.4mm 34.6° x 19.9° 152mm 2° x 1.1°	(1x) 4.5mm 60.3° x 36.2° 77mm 3.9° x 2.2° (2x) -	(1x) 4.7mm 58.2° x 34.7° 94mm 3.2° x 1.8° (2x) -
Filter Thread	M82 x 0.75	M82 x 0.75	M82 x 0.75
Approx. Size	Φ85 x 214.1mm(ΦxLength)	Φ85 x 175.6mm(ΦxLength)	Φ85 x 189.8mm(ΦxLength)
Approx. Mass	1.66kg (without lens hood)	1.28kg (without lens hood)	1.48kg (without lens hood)

Remote Control Lenses



Model Name	ZA12x4.5BMD*	ZA17x7.6BMD*	ZA22x7.6BMD*
Focal Length (1x)/(2x)	4.5–54mm / 9–108mm	7.6–130mm / 15.2–260mm	7.6–167mm / 15.2–334mm
Zoom Ratio	12 x	17 x	22 x
Extender	2 x	2 x	2 x
Maximum Relative Aperture (F-No.)	1 : 1.8(4.5–41mm) 1 : 2.4(54mm)	1 : 1.8(7.6–102mm) 1 : 2.3(130mm)	1 : 1.8(7.6–120mm) 1 : 2.5(167mm)
Minimum Object Distance (M.O.D.)	0.3m	0.6m	0.8m
Object Dimensions at M.O.D. 16:9 Aspect Ratio	(1x) 4.5mm 757 x 425mm 54mm 59 x 33mm (2x) 9mm 373 x 210mm 108mm 31 x 17mm	(1x) 7.6mm 696 x 392mm 130mm 43 x 24mm (2x) 15.2mm 362 x 204mm 260mm 22 x 12mm	(1x) 7.6mm 915 x 514mm 167mm 43 x 24mm (2x) 15.2mm 473 x 266mm 334mm 22 x 12mm
Angular Field of View 16:9 Aspect Ratio	(1x) 4.5mm 93.6° x 61.8° 54mm 10.1° x 5.7° (2x) 9mm 56.1° x 33.3° 108mm 5.1° x 2.9°	(1x) 7.6mm 64.5° x 39° 130mm 4.2° x 2.4° (2x) 15.2mm 35° x 20.1° 260mm 2.1° x 1.2°	(1x) 7.6mm 64.5° x 39° 167mm 3.3° x 1.8° (2x) 15.2mm 35° x 20.1° 334mm 1.6° x 0.9°
Filter Thread	M127 x 0.75 (Filter attaches to the lens hood.)	M82 x 0.75	M95 x 1 / M107 x 1 (Filter attaches to the lens hood.)
Approx. Size	Φ95 x 237.5mm(ΦxLength)	Φ85 x 203mm(ΦxLength)	Φ100 x 220.4mm(ΦxLength)
Approx. Mass	1.88kg (without lens hood)	1.60kg (without lens hood)	1.8kg (without lens hood)

*BEMD type is also available. For more information, please contact nearest our FUJIFILM office.

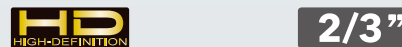

Model Name	XA20sx8.5BMD	XA20sx8.5BEMD
Focal Length (1x)/(2x)	8.5–170mm / -	8.5–170mm / 17–340mm
Zoom Ratio	20 x	20 x
Extender	-	2 x
Maximum Relative Aperture (F-No.)	1:1.8(8.5–113mm) 1:2.7(170mm)	1:1.8(8.5–113mm) 1:2.7(170mm)
Minimum Object Distance (M.O.D.)	0.9m	0.9m
Object Dimensions at M.O.D. 16:9 Aspect Ratio	(1x) 8.5mm 910 x 511mm 170mm 47 x 26mm (2x) -	(1x) 8.5mm 910 x 511mm 170mm 47 x 26mm (2x) 17mm 469 x 264mm 340mm 24 x 13mm
Angular Field of View 16:9 Aspect Ratio	(1x) 8.5mm 58.9° x 35.2° 170mm 3.2° x 1.8° (2x) -	(1x) 8.5mm 58.9° x 35.2° 170mm 3.2° x 1.8° (2x) 17mm 31.5° x 18° 340mm 1.6° x 0.9°
Filter Thread	M82 x 0.75	M82 x 0.75
Approx. Size	Φ85 x 180.8mm(ΦxLength)	Φ85 x 180.8mm(ΦxLength)
Approx. Mass	1.5kg (without lens hood)	1.6kg (without lens hood)

ENG/EFP Portable Lens System Configuration

Full-Servo Control Kit (Servo Focus / Servo Zoom)

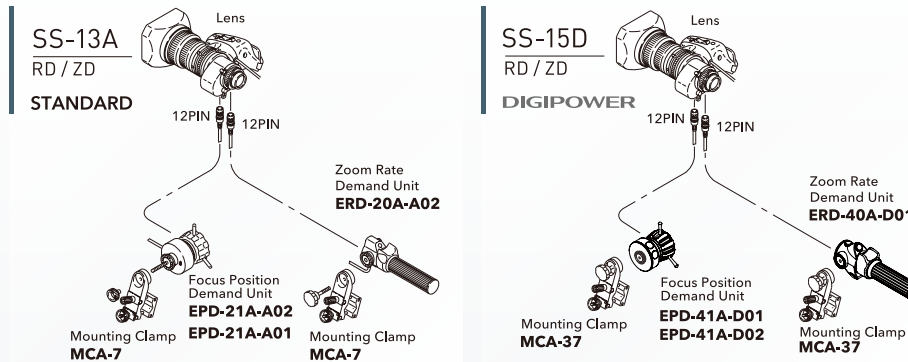

Semi-Servo Control Kit (Manual Focus / Servo Zoom)

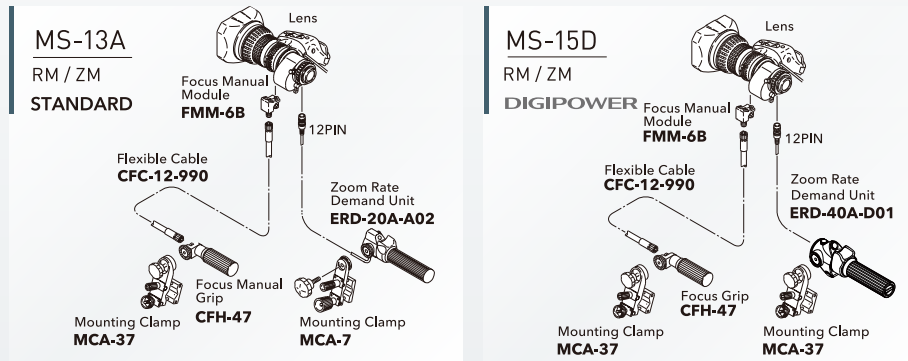

Control Accessories Compatibility (Premier Series, Select Series and Broadcast Lenses)

HA18 x 7.6 BE [RM]		Lens Drive Unit Type			
		Description	Model Name	RM	RD/ZD
Focus	Manual	Focus Grip	CFH-47	●	●
		Mounting Clamp	MCA-37	●	●
		Flexible Cable	CFC-12-990	●	●
		Focus Manual Module	FMM-6B	●	●
Focus	Servo	Digital Focus Position Demand Unit	EPD-41A-D01 / D02	●	●
		Mounting Clamp	MCA-37	●	●
		Focus Position Demand Unit	EPD-21A-A01 / A02	●	●
		Mounting Clamp	MCA-7	●	●
		Focus Servo Position Module	FSP-13G	●*1	●
		Digital Shot Box	ESB-6C-E12B	●	●
		Mounting Clamp	MCA-06BC	●	●
Zoom	Servo	Digital Zoom Rate Demand Unit	ERD-40A-D01	●	●
		Mounting Clamp	MCA-37	●	●
		Zoom Rate Demand Unit	ERD-20A-A02	●	●
Other		Mounting Clamp	MCA-7	●	●
		VTR Control Unit	VRS-20	●	●
		Return Control Unit	EXT-30	●	●
		Lens Supporter	ALH-127A-01A (for 46x series, for 42x series)	●	●
		External OS-TECH Adapter	TS-P58A (HA14, HA18, HA22, HA23, HA25, HA42)	●	●
		OS-TECH Control Unit	EA-12A-03BA	●	●
		Extension Cable For Focus Position Demand Unit/Zoom Rate Demand Unit	ECE-1000 (1m) / -2000 (2m) / -3000 (3m) / -4000 (4m) / -5000 (5m) / -10000 (10m)*2	●	●
		Cable for Lens ↔ PC	SA-206D-005 / SA-206A-005 *3	●	●
		2x Extender Change Unit (Motor Drive)	ECU-2C	●	●
		ECU Adapter (for UA22x)	ECU-1AD	●	●
ECU Adapter (for UA13x)	ECU-2AD	●	●		

*1: It is available only with EPD-21-A01/A02 *2: Longer Cables are also available *3: SA-206A-005 is specifically designed for HA25x, HA42x

Digital Zoom Demand

ERD-40A-D01



	DIP No.	Function
AUX1	1-1	OIS(Alternate)
	1-2	Preset Zoom
	1-3	Preset Z+F
	1-4	EXT
	1-5	INCOM(ENG)
Zoom Mode Switch	1-6	INCOM(PD)
	1-7	Z curve select
RET2/AUX SEL	1-8	Z curve select
	2-1	RET2 ↔ AUX2
RET1	2-2	ON/OFF
	2-3	ON/OFF
AUX2	2-4	VTR(REC)
	2-5	EXT
	2-6	INCOM(ENG)
	2-7	INCOM(PD)
	2-8	OIS(Alternate)

Digital Focus Demand

EPD-41A-D01/ D02

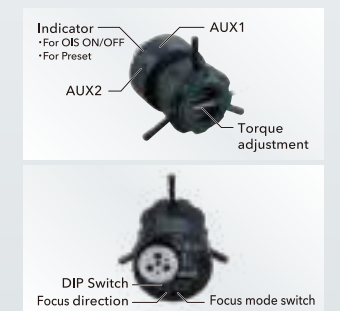

	DIP No.	Function
AUX1	1	RET1
	2	AUX1 ↔ AUX2
	3	RET2
AUX2	4	OIS
	5	PRESET

eXceed Series System Configuration

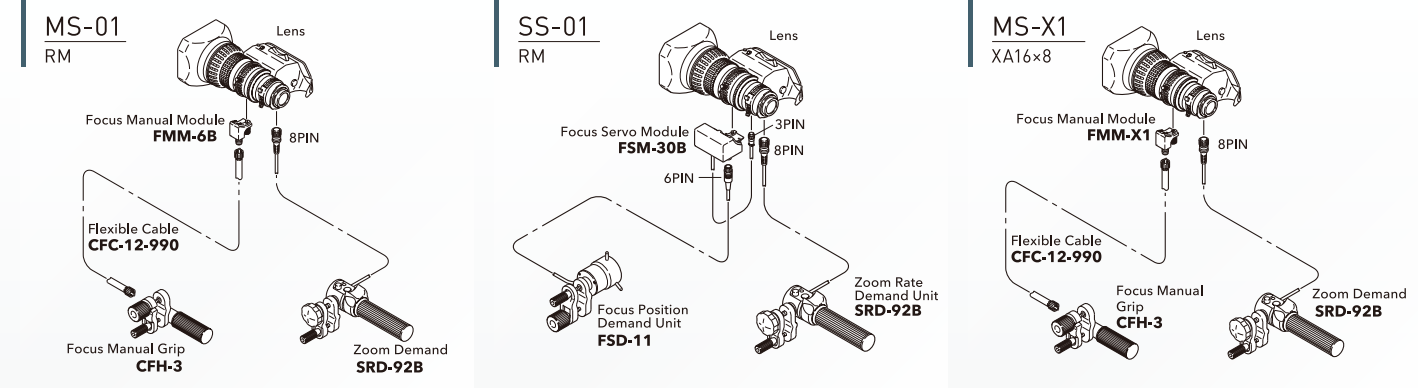

Control Accessories Compatibility

XA20s × 8.5 BE [RM]		RM		
Focus	Manual	Description	Model Name	Standard
		Focus Grip	CFH-3	●
		Flexible Cable	CFC-12-990	●
		Focus Manual Module	FMM-6B	●
			FMM-X1 (for XA16x8)	●
	Servo	Focus Servo Module	FSM-30B	●
		Focus Position Demand Unit	FSD-11	●
Zoom	Servo	Zoom Rate Demand Unit	SRD-92B	●
Other		VTR Control Unit	VRS-2	●
		Extension Cable For Focus Servo Demand Unit (FSD-11)	ECA-1000(1m) / -5000(5m) / -10000(10m)*	
		Extension Cable For Zoom Rate Demand Unit (SRD-92B)	ECC-1000(1m) / -5000(5m) / -10000(10m)*	
		For 12PIN Lens Cable	ECE-R22	

* Longer Cables are also available.



Mount Adapters

Model Name	Camera	Lens	Note
ACM-8B	1/2" Sony Bayonet Mount	2/3" Bayonet Mount	Angle of view is approx. 1.3x shifted to tele side
ACACM-19	1/3" Bayonet Mount	1/2" Sony Bayonet Mount	Angle of view is approx. 1.3x shifted to tele side
ACM-17	1/3" Bayonet Mount	2/3" Bayonet Mount	Angle of view is approx. 1.6x shifted to tele side
ACM-21	SONY PMW-300	2/3" Bayonet Mount	Angle of view is approx. 1.4x shifted to tele side
ACM-24	SONY 1.25" Mount	2/3" Bayonet Mount	Angle of view is approx. 1.7x shifted to tele side.

Fujifilm has variety of Mount Adapters. For more detail, please ask our sales office.



HD REMOTE CONTROL LENSES

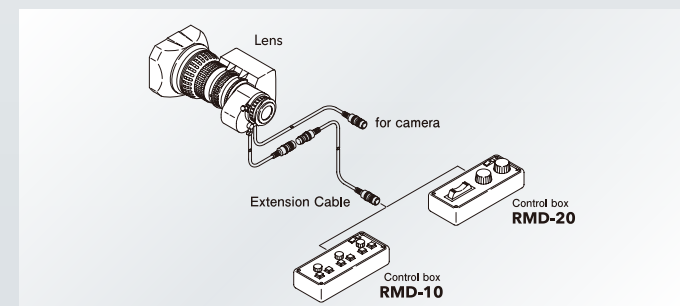

Control Accessories Compatibility

ZA17×7.6 BE [MD]		MD
Description	Model Name	
Remote Controller	RMD-10	●
	RMD-20	●
Extension Cable	ECM-005M(5m) / -010M(10m) / -020M(20m) / -030M(30m) / -050M(50m) / -100M(100m)*	
Extender Change Unit	ECU-12A	

* Longer Cables are also available.

Optical Accessories for Portable Lenses

Optical accessories expand the capabilities of FUJINON TV lenses.

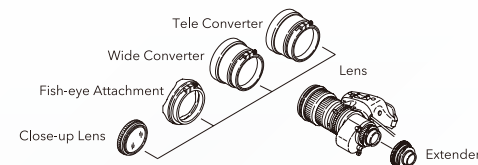

Tele Converter [TCV]

▶ Focal length is multiplied by the magnification of the converter on the telephoto side. ▶ Zooming possible. ▶ The F-No. on the master lens remains unchanged. ▶ M.O.D. is increased. ▶ Loss of picture edges will occur toward the wide angle side of the zoom range.



Wide Converter [WCV]

▶ Focal length is multiplied by the magnification of the converter on the wide side. ▶ Zooming possible. ▶ The F-No. on the master lens remains unchanged. ▶ M.O.D. is decreased.



Wide Attachment [WAT]

▶ Converts only the wide end of the lens by the magnification of the attachment. ▶ Zooming not possible. ▶ The F-No. on the master lens remains unchanged. ▶ Focus is adjustable only by the macro lever of master lens located near the lens mount.



Fish-eye Attachment [F-AT]

▶ Converts only the wide end of the lens by the magnification of the attachment. ▶ Zooming not possible. ▶ The F-No. on the master lens remains unchanged. ▶ Focus is adjustable only by the macro lever of master lens located near the lens mount.



Close-up Lens [CL]

▶ Close-up lens provides a shorter minimum focusing distance between lens and object. ▶ Ideal for copy stand or other close up work.



2×Extender

▶ 2× range extender mounts between master lens and camera and doubles the focal length of the master lens. ▶ F-No. is doubled. ▶ Includes back focus adjustment.



* AE20B-2 is specifically designed for SDTV lens.

LENS	XA20s×8.5 XS20s×6.3 XT17s×4.5 XT20s×4.7	UA18×7.6 HA18×7.6 HTs18x4.2 ZA17×7.6 ZS17×5.5	UA24×7.8 UA23×7.6 HA23×7.6 ZA22×7.6
Front Lens Diameter	ø 85		ø 100

Model Name	Magnification	Approx. Mass(kg)		
TCV-U85	1.5×	1.10	●	
TCV-U100		1.00		●
WCV-U85	0.8×	1.24	●	
WCV-U100		1.20		●
WAT-U85	0.7×	0.36	●	
WAT-U100		0.53		●
F-ATU85	0.55×	0.71	●	
F-ATU100		0.67		●

Model Name	Object Distance	Approx. Mass(kg)		
UCL-8082SC		0.28	M82×0.75	
UCL-8095SC	0.8m	0.42		M95×1

Model Name	Magnification	Approx. Mass(kg)		
HAeE14-1	1.4×	0.30		
AE20B-2	2.0×	0.17		

Effects Filter

Attach to filter screw portion of the zoom lens.

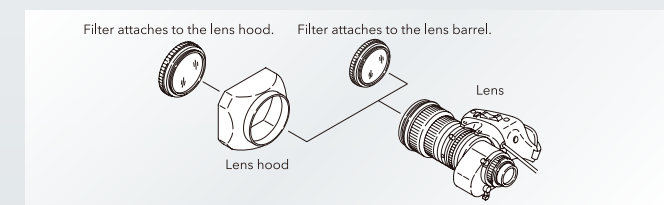

Protection Filter [EPF]

Professional protect filter offers superior protection against dust, moisture and scratches and can permanently remain on the lens.

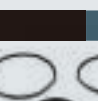

Polarizing Filter [PL]

▶ Polarizing filter reduces polarized light reflections from glass and water surfaces or to improve color saturation. ▶ Enhances picture quality by blocking harmful reflected light. ▶ Circular type



LENS	UA18×7.6 HA18×7.6 HTs18x4.2 ZA17×7.6 ZS17×5.5 XA20s×8.5 XS20s×6.3 XT17s×4.5 XT20s×4.7	UA24×7.8 UA23×7.6 HA23×7.6 ZA22×7.6	HA25×11.5 HA25×16.5	UA13×4.5 UA14×4.5 UA18×5.5 UA22x8 HA14×4.5 HA18×5.5 HA22×7.3 ZA12×4.5 XS13×3.3 HP12×7.6	UA46×9.5 UA46x13.5 HA42×9.7 HA42×13.5
Lens Barrel Filter Thread Size	M82×0.75	M95×1	M107×1	—	M127×0.75
Hood Filter Thread Size	—	M107×1	M127×0.75	M127×0.75	—

Model Name				
EPF-82	●			
EPF-95		●		
EPF-107		●	●	
EPF-127			●	●
EFL-82PL	●			
EFL-95PL		●		
EFL-107PLA		●	●	
EFL-127PL			●	●

8K LENS

Fujifilm optical lens technology
Lenses that support state-of-the-art
8K broadcasting

8K images have approximately 33 million pixels—that's 16 times as many as full HD and four times as many as 4K UHD. Besides its awe-inspiring resolution, 8K offers a wider brightness range and an extended color spectrum, giving rich, detailed gradation and thus gorgeously expressive images. To bring the world ultra-high-definition 8K broadcasts requires the development of technologies for image input, transmission, and output, and a stable supply of 8K-compatible equipment. Fujifilm responds to today's high-quality-image needs by developing lenses that give full rein to the potential of state-of-the-art 8K broadcasting.



HP66x15.2-ESM System Configuration

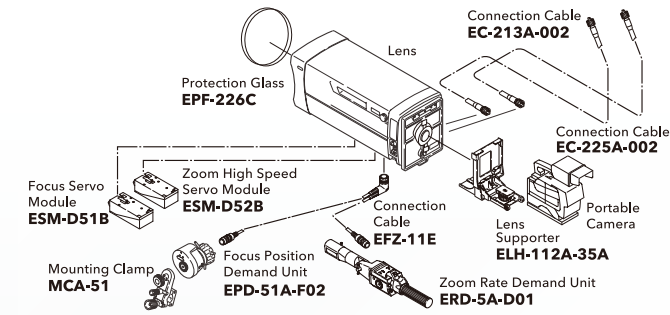

Description	Model Name
Zoom Rate Demand Unit	ERD-5A-D01
Focus Position Demand Unit	EPD-51A-F02
Mounting Clamp	MCA-51
Servo Module	ESM-D51B
	ESM-D52B
Connection Cable	EFZ-111E
	EC-213A-002
	EC-225A-002
Lens Supporter	ELH-112A-35A
Protection Glass	EPF-226C

HP12x7.6ERD-S9 System Configuration

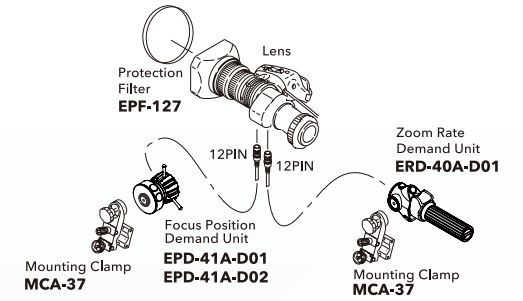

Description	Model Name
Zoom Rate Demand Unit	ERD-40A-D01
Focus Position Demand Unit	EPD-41A-D02
Mounting Clamp	MCA-37
Protection Filter	EPF-127

Other

Description	Model Name
Close up Lens for SK7.5x19.7	HCL-SH95152SC

8K 1.25" Mount Series

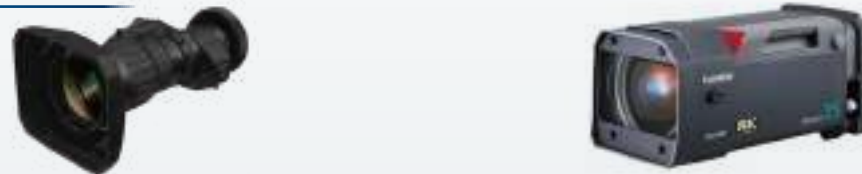

Model Name	HP12x7.6ERD-S9	HP7.5x8.5-SM
Focal Length	(1x)7.6-91mm (1.4x)10.64-127.4mm	(1x)8.5-64mm
Zoom Ratio	12x	7.5x
Extender	1.4x	—
Maximum Relative Aperture(F-No.)	1:3.1(7.6-69mm) 1:4.1(91mm)	1:2.2(8.5-64mm)
Minimum Object Distance (M.O.D.)from Front Lens	0.3m	0.8m
Object Dimensions at M.O.D. 16:9 Aspect Ratio	(1x) 7.6mm 370x200mm 91mm 29x17mm	(1.4x) 10.64mm 262x143mm 127.4mm 21x12mm
Angular Field of View 16:9 Aspect Ratio	(1x) 7.6mm 93.3°x61.8° 91mm 10.1°x5.7°	(1.4x) 10.64mm 74.2°x46.3° 127.4mm 7.2°x4.1°
Filter Thread	M127x0.75	—
Approx.Size	Φ95x267(ΦxLength)	267.2x249x534(H x W x L)
Approx.Mass	2.7kg(without lens hood)	25kg

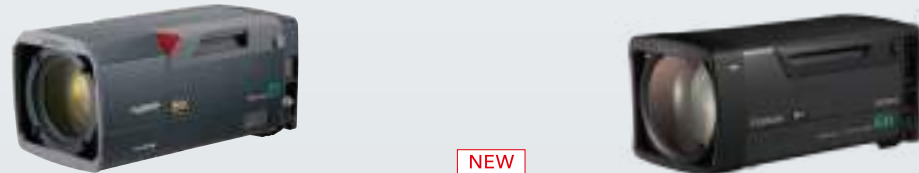

Model Name	HP11x22.5-SM	HP66x15.2-ESM
Focal Length	(1x)22.5-250mm	(1x)15.2-1000mm (1.4x)21.5-1414mm
Zoom Ratio	11x	66x
Extender	—	1.4x
Maximum Relative Aperture(F-No.)	1:2.2(22.5-250mm)	1:2.9(15.2-592mm) 1:4.9(1000mm)
Minimum Object Distance (M.O.D.)from Front Lens	3m	3.7m
Object Dimensions at M.O.D. 16:9 Aspect Ratio	(1x) 22.5mm 2409x1355mm 250mm 207x116mm	(1x) 15.2mm 3495x1966mm 1000mm 55x31mm
Angular Field of View 16:9 Aspect Ratio	(1x) 22.5mm 39.4°x22.9° 250mm 3.7°x2.1°	(1.4x) 21.5mm 2502x1408mm 1414mm 39x22mm
Filter Thread	—	—
Approx.Size	265x272x617.4(H x W x L)	258x264x610(H x W x L)
Approx.Mass	26kg	24.7kg

8K PL Mount Series



Model Name	SK3x12-SM	SK7.5x19.7-SM	SK20x35-ESM
Focal Length	(1x)12-36mm	(1x)19.7-148mm	(1x)35-700mm (1.4x)49-980mm
Zoom Ratio	3x	7.5x	20x
Extender	—	—	1.4x
Maximum Relative Aperture(F-No.)	1:2.8(12-36mm)	1:2.8(19.7-148mm)	1:2.8(35-315mm) 1:4.8(700mm)
Minimum Object Distance (M.O.D.)from Front Lens	0.4m	1.2m	3.5m
Object Dimensions at M.O.D. 16:9 Aspect Ratio	(1x) 12mm 945x532mm 36mm 304x171mm	(1x) 19.7mm 1663x936mm 148mm 216x122mm	(1x) 35mm 2631x1480mm 700mm 132x74mm
Angular Field of View 16:9 Aspect Ratio	(1x) 12mm 91.4°x59.8° 36mm 37.7°x21.7°	(1x) 19.7mm 64.0°x38.6° 148mm 9.5°x5.3°	(1.4x) 49mm 28.2°x16.0° 980mm 1.4°x0.8°
Filter Thread	M152x1	M149x1	—
Approx.Size	Φ160x379.2(ΦxLength)	Φ160x417.5(ΦxLength)	258x264x714(H x W x L)
Approx.Mass	7.4kg	9.7kg	31.2kg

Horizontal Field of View (16:9)	93.3	91.4	86.9	64.0	55.8	39.4	38.7	37.7	14.3	10.1	9.5	3.7	2.0	0.9
1.25" Format*1	7.6		8.5		15.2	22.5			64	91		250		1000
Focal Length	S35mm Format*2		12	19.7		35	36		148	700				
2/3" Format Equivalent	4.5	4.7	5.1	7.7	9.0	13.4	13.7	14.0	38.1	54.1	57.7	148.6	273.0	594.6
HP12x7.6ERD-S9	[Bar chart showing field of view for HP12x7.6ERD-S9]													
HP7.5x8.5-SM	[Bar chart showing field of view for HP7.5x8.5-SM]													
HP11x22.5-SM	[Bar chart showing field of view for HP11x22.5-SM]													
HP66x15.2-ESM	[Bar chart showing field of view for HP66x15.2-ESM]													
SK3x12-SM	[Bar chart showing field of view for SK3x12-SM]													
SK7.5x19.7-SM	[Bar chart showing field of view for SK7.5x19.7-SM]													
SK20x35-ESM	[Bar chart showing field of view for SK20x35-ESM]													

*1 Sensor size:16.1x9.1 *2 Sensor size:24.6x13.8

FUJINON Cine Lenses

Fujifilm has been developing the FUJINON Cine Lens since 2002. We are not only making excellent use of our optical, mechanical, and electronic knowledge which have been cultivated in the broadcast lens field, but we also have enhanced those technologies to achieve superb Cine Lenses. FUJINON Cine Lenses allow cinematographers to explore the possibility of creating new images around the world that represent the broad range of human emotions.

Premista Series

Premista Series support large-format sensors and deliver outstanding high resolution, beautiful bokeh and rich gradation with HDR (high dynamic range). The Premista Series can bring out the maximum capability of large format sensors, which are increasingly being adopted into cinema camera, to provide robust support for high-quality video production.



HK Premier Series

Fujifilm engineers exhaustively develop the HK Premier Series utilizing our expertise and knowledge gained from the lens design process honed over many years. The contrast performance is rich, the resolution - superb. The net results are lenses with excellent overall balance.



ZK Cabrio Series

The ZK Cabrio Series features a unique detachable servo drive unit*. With the drive unit, these lenses operate like traditional ENG TV lenses thanks to the same interface and accessories familiar to TV lens users. On the other hand, with the drive unit removed, this lens has standard 0.8 cine gearing, allowing for the use of traditional third party cine accessories.

*Servo drive unit for ZK 12x25 is optionally available.



XK Cabrio Series

The XK Cabrio Series also equip operational features of ZK Cabrio Series. The lens offers 4K compatible optical performance and covers a wide range of focal length from 20mm to 120mm.

It also realizes T3.5 brightness in the entire zoom range. Various scenes can be shot with this single lens.



MK Series

The MK series offers T2.9 speed through 18-55mm and 50-135mm focal length. The lenses achieve advanced optical performance into their compact and lightweight body, thanks to Super 35mm / APS-C sensor compatibility and dedicated E-mount design. They minimize focal shift and optical axis shift while zooming, and lens breathing that are typically observed in interchangeable lenses for digital cameras.



Premista Series



Living Large Capture Your Cinematic Vision

Overwhelming Quality and a Wide Range of Focal Lengths

Superb Optical Performance Delivering the Full Benefits of a Large Format Sensor

Adopting large diameter aspherical elements, Premista achieves stunning optical quality and low distortion from the center to the corner, capturing both the feeling and texture of the subjects. Furthermore, by combining newly developed focus and zoom systems, they deliver clean and sharp imagery with minimum color aberrations regardless of zoom position or distance from the subject, which rivals the performance of a prime lens.

Performs Well with High Dynamic Range for Expanding the Visual Expression

Unwanted flare and ghosts are well suppressed thanks to in-house optical calculation software. Premista performs well with the high dynamic range of a large format sensor. The color is natural and neutral due to the choice of glass elements and coatings. It's matched with Fujifilm's current cine lens lineup to simplify color grading that is required when using a combination of multiple lenses.

Covering the Frequently-used Range of Focal Lengths from 19-250mm with 3 Lenses

The lineup includes a standard zoom lens (28-100mm), telephoto zoom lens (80-250mm) and wide-angle zoom lens (19-45mm). Combining these three lenses, they cover the most frequently used focal lengths of 19-250mm. Premista also features a constant T2.9 aperture (through 200mm on the telephoto zoom). Unlike when using a prime lens, they save both time and cost caused by changing lenses frequently.



Tobias A. Schliessler, ASC

"I've been a fan of the FUJINON Zoom lenses since my first experience on Lone Survivor, where I used the 19-90mm Cabrio and the Premier zooms for the first time, I have since used them on all on my spherical feature films and commercials. I am happy to have the Premista for my large format work. The lens has the same contrast, sharpness, color characteristics, quality, and lack of lens breathing as the Premier zooms."

Premista Series

Horizontal Field of View (16:9)		86.9	65.5	43.6	25.4	20.4	8.2
Focal Length	Large format*1	19	28	45	80	100	250
	S35mm Format*2	13	19	31	55	68	171
	2/3" Format Equivalent	5.1	7.5	12.0	21.3	26.6	66.6
Premista19-45mm T2.9							
Premista28-100mm T2.9							
Premista80-250mm T2.9-3.5							

*1 Sensor size:36x24 *2 Sensor size:27.45x15.44



Excellent Usability for Professional Use

Combining Lightweight and High Durability

The Premista design combines both a lightweight of 3.3kg (19-45mm) / 3.8kg (28-100mm,80-250mm) and compact size as well as the renowned durability that FUJINON lenses are known for even in the harshest of professional conditions. These zoom lenses are especially convenient when used on a crane or a helicopter where it is difficult to access the lens.

Accurate and Comfortable Operation to Assist Film Crews

The focus ring features a rotation of a full 280 degrees to facilitate precise focusing even with a shallow depth-of-field. In addition, a Flange Focal Distance adjustment function with a hex set screw is standard in order to easily achieve optimum camera and lens matching, thereby bringing out the lenses' full optical performance even if there are sudden changes of temperature.

Efficient Work Flow Compatible with ZEISS eXtended Data*1

The Premista series is compatible with the "ZEISS eXtended Data" system developed by ZEISS based on the open/8® Technology*2 standard. It enables the recording of lens metadata (focus, zoom, and iris position) and lens distortion and shading corrections.*3

*1 Available via firmware update.

*2 /8® is a registered trademark of Cooke Optics Limited used with permission.

*3 Compatible devices are required depending on the cameras to be used.



Model Name	Premista 19-45mmT2.9	Premista 28-100mmT2.9	Premista 80-250mmT2.9-3.5
Focal Length	19-45mm	28-100mm	80-250mm
Aperture	T2.9	T2.9	T2.9(80-200mm) / T3.5(250mm)
Lens Mount	PL mount	PL mount	PL mount
Compatible Image Size (diagonal)	46.3mm	46.3mm	46.3mm
Close Focus	0.6m / 2ft	0.8m / 2ft 7in	1.5m / 4ft 11in
Angular Field of View (HxV)	19mm : 94.3° × 59.2° 40.96mm × 21.60mm*4	28mm : 72.4° × 42.2° 100mm : 23.1° × 12.3°	80mm : 28.7° × 15.4° 250mm : 9.4° × 4.9°
Angular Field of View (HxV)	19mm : 86.9° × 64.6° 45mm : 43.6° × 29.9°	28mm : 65.5° × 46.4° 100mm : 20.4° × 13.7°	80mm : 25.4° × 17.1° 250mm : 8.2° × 5.5°
Angular Field of View (HxV)	19mm : 71.7° × 44.2° 45mm : 33.9° × 19.5°	28mm : 52.2° × 30.8° 100mm : 15.6° × 8.8°	80mm : 19.5° × 11.0° 250mm : 6.3° × 3.5°
Focus Rotation	280°	280°	280°
Zoom Rotation	120°	120°	120°
Iris Rotation	48°	48°	48°
Iris Blades	13	13	13
Front Diameter	114mm	114mm	114mm
Length (approx.)	228mm / 9in	255mm / 10in	255mm / 10in
Weight (approx.)	3.3kg / 7.3lbs.	3.8kg / 8.4lbs.	3.8kg / 8.4lbs.

*4 Aspect ratio 1:1.90 *5 Aspect ratio 1:1.50 *6 Aspect ratio 1:1.78

HK ZK XK MK Series

Exceptional Lens Design Delivers Outstanding Optical Performance

FUJINON Cine Lenses deliver outstanding optical performance thanks to the combination of fluorite elements, extra-low-dispersion (ED) glass and large-aperture aspheric lenses to suppress aberrations. Image resolution from edge to edge has been dramatically improved while minimizing distortion and fluctuations in angle of view during focusing. In addition, variations in optical performance are reduced when zooming, providing superb images over the entire zoom range from wide to telephoto. Plus, our unique HT-EBC coating achieves high transmittance and low reflectance, enabling an image expression with rich color reproduction.

9-Blade Iris for Natural Bokeh*1

HK ZK XK MK

In developing the 9-blade diaphragm for these FUJINON Cine Lenses, extensive simulations were performed to optimize the number and shape of the blades to render out-of-focus areas more naturally. Light generated when shooting point light sources are more circular, making it possible to render a more pleasing, natural bokeh.

*1 The Premista series uses a 13-blade diaphragm to provide a even more natural bokeh based on the latest technology.



Detachable Digital Servo Grip*2

ZK XK

ZK and XK Series lenses feature an advanced "Detachable" drive unit, a first in the Light Weight Zoom category. These lenses feature hybrid technologies from both our broadcast and cine lenses.

With the drive unit attached, these lenses can be operated like traditional ENG TV lenses thanks to the same interface and accessories. This is exceptionally helpful in simplifying and reducing set up time. Therefore, it is not necessary to use more complicated cine lens drive systems.

*2 Mounted as standard in ZK14-35mm T2.9, ZK19-90mm T2.9, ZK85-300mm T2.9-4.0 and XK20-120mm T3.5; optional on the ZK25-300mm T3.5-3.85.

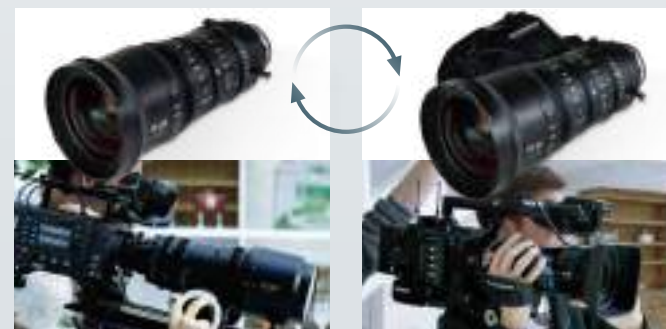

Cinema style

Broadcast style

Mechanical design for good manual operability

HK ZK XK MK

FUJINON Cine lenses are designed by emphasizing good manual operability.

Operation is smooth with free of torque changes and jerkiness.

Smooth focusing with no torque variation or friction helps accurate focus adjustment.

The gear rings for focus, zoom and iris adjustment have a pitch of 0.8M, the same as existing FUJINON cine lenses, for compatibility with standard cine accessories.

An original universal font for markings offers excellent visibility in any shooting situation.



HK Premier Series

Horizontal Field of View (16:9)	79	67	53	30	18	16	7.6	3.4	
Focal Length	S35mm Format*	14.5	18	24	45	75	85	180	400
	2/3" Format Equivalent	5.8	7.2	9.6	18	30	34	72	160
HK14.5-45mm T2.0									
HK18-85mm T2.0									
HK24-180mm T2.6									
HK75-400mm T2.8-3.8									

*Sensor size : 24.0 x 13.5

ZK Cabrio Series

Horizontal Field of View (16:9)	89	72	58	43	18	17	5	
Focal Length	S35mm Format*	14	19	25	35	85	90	300
	2/3" Format Equivalent	4.9	6.6	8.7	12	30	31	104
ZK14-35mm T2.9								
ZK19-90mm T2.9								
ZK85-300mm T2.9-4.0								
ZK25-300mm T3.5-3.85								

*Sensor size : 27.45 x 15.44

XK Cabrio Series

Now available without drive unit

Horizontal Field of View (16:9)	64	12	
Focal Length	S35mm Format*	20	120
	2/3" Format Equivalent	7.7	46.3
XK20-120mm T3.5			

*Sensor size : 24.84 x 13.97

MK Series

Horizontal Field of View (16:9)	69.2	27.9	25.4	10.5	
Focal Length	S35mm Format*	18	50	55	135
	2/3" Format Equivalent	6.9	19.3	21.2	52.1
MK18-55mm T2.9					
MK50-135mm T2.9					

*Sensor size : 24.84 x 13.97

Power supply

ZK XK

The power for the servo drive unit is available via a hot-shoe mount or external power supply.*1

For the external power supply, you can connect to the camera (12 pin) or power-supply box (XLR 4 pin / D-tap) by optional cables.

Equipped 16 bit encoder

ZK XK

16bit encoder provides accurate information of zoom, focus and iris settings, which matches highprecision virtual systems.

Lens-data communication system

ZK XK

FUJINON Cine lenses support ARRI LDS system and Cooke /i Technology, which are widely employed in cinema cameras. It allows users to transmit the data of the lens position to the camera and thus to enhance the efficiency of operation.*2

*1 Power supply for the lens varies according to the type of camera.

*2 Lens-data communication system is available with the drive unit attached. Cameras need to be compatible with the communication system.

Compatible with the existing operation accessories

ZK XK

FUJINON Cine lenses can be used with existing wired zoom and focus demands for control, which offers the operability equivalent to conventional TV camera lenses.



ZK / XK series switch for activating functions of the driving unit



Upper side switch

- (1) Quick Zoom ON/OFF switch
- (2) VTR-Quick Zoom switch
- (3) Return-Quick Zoom switch
- (4) Iris default setting for Auto-Manual switch
- (5) Auto-cruising Zoom ON/OFF switch
- (6) Back-up switch
- (7) Iris A-M position selector switch
- (8) Back-up switch

Lower side switch

- (1) Camera communication ON/OFF switch
- (2) Camera communication method selector switch (ON: ARRI LDS; OFF: Cooke /i)
- (3) Analog Zoom Demand and Zoom Mode function ON/OFF switch
- (4) Back-up switch

*The power supply for running the servo drive unit of the ZK series lens varies depending on the camera to be attached.

FUJINON Cine Lenses

HK Premier Series



Model Name	HK14.5-45mm T2.0	HK18-85mm T2.0
Application	35mm PL Mount Camera	35mm PL Mount Camera
Focal Length	14.5–45mm	18–85mm
Zoom Ratio	3.1 x	4.7 x
T-No.	T2.0	T2.0
Compatible Image Size(diagonal)	Maximum 27.5mm	Maximum 27.5mm
Iris Blades	9	9
M.O.D.from Image Planes	0.71m / 2ft 4in	0.82m / 2ft 8in
Object Dimensions at M.O.D. 1.78:1 Aspect Ratio*	14.5mm 693 x 390mm 45mm 215 x 121mm	18mm 656 x 369mm 85mm 139 x 78mm
Angular Field of View 1.78:1 Aspect Ratio*	14.5mm 79.2° x 49.9° 45mm 29.9° x 17.1°	18mm 67.4° x 41.1° 85mm 16.1° x 9.1°
Focus Rotation	280°	280°
Zoom Rotation	160°	160°
Approx. Size	Φ136 x 310mm(ΦxLength)	Φ136 x 352mm(ΦxLength)
Approx. Mass	6.5kg	7.0kg



Model Name	HK24-180mm T2.6	HK75-400mm T2.8-3.8
Application	35mm PL Mount Camera	35mm PL Mount Camera
Focal Length	24–180mm	75–400mm
Zoom Ratio	7.5 x	5.3 x
T-No.	T2.6	T2.8(75-290mm) T3.8(400mm)
Compatible Image Size(diagonal)	Maximum 27.5mm	Maximum 27.5mm
Iris Blades	9	9
M.O.D.from Image Planes	1.24m / 4ft 1in	2m / 6ft 7in
Object Dimensions at M.O.D. 1.78:1 Aspect Ratio*	24mm 924 x 520mm 180mm 119 x 67mm	75mm 580 x 326mm 400mm 113 x 64mm
Angular Field of View 1.78:1 Aspect Ratio*	24mm 53.1° x 31.4° 180mm 7.6° x 4.3°	75mm 18.2° x 10.3° 400mm 3.4° x 1.9°
Focus Rotation	280°	280°
Zoom Rotation	160°	160°
Approx. Size	Φ136 x 405mm(ΦxLength)	Φ136 x 444mm(ΦxLength)
Approx. Mass	8.9kg	9.1kg

ZK Cabrio Series



Model Name	ZK14-35mm T2.9	ZK85-300mm T2.9-4.0
Application	35mm PL Mount Camera	35mm PL Mount Camera
Focal Length	14–35mm	85–300mm
Zoom Ratio	2.5 x	3.5 x
T-No.	T2.9	T2.9(85–218mm) T4.0(300mm)
Compatible Image Size(diagonal)	Maximum 31.5mm	Maximum 31.5mm
Iris Blades	9	9
M.O.D.from Image Planes	0.6m / 2ft	1.2m / 3ft 11in
Object Dimensions at M.O.D. 1.78:1 Aspect Ratio**	14mm 701 x 394mm 35mm 275 x 155mm	85mm 274 x 154mm 300mm 79 x 44mm
Angular Field of View 1.78:1 Aspect Ratio**	14mm 88.9° x 57.7° 35mm 42.8° x 24.9°	85mm 18.3° x 10.4° 300mm 5.2° x 2.9°
Focus Rotation	200°	200°
Zoom Rotation	120°	120°
Approx. Size	Φ114 x 231mm(ΦxLength)	Φ114 x 249mm(ΦxLength)
Approx. Mass	2.9kg (with Drive Unit) / 2.4kg (without Drive Unit)	3.1kg (with Drive Unit) / 2.6kg (without Drive Unit)



Model Name	ZK19-90mm T2.9	ZK25-300mm T3.5-3.85
Application	35mm PL Mount Camera	35mm PL Mount Camera
Focal Length	19–90mm	25–300mm
Zoom Ratio	4.7 x	12 x
T-No.	T2.9	T3.5(25-273mm) T3.85(300mm)
Compatible Image Size(diagonal)	Maximum 31.5mm	Maximum 31.5mm
Iris Blades	9	9
M.O.D.from Image Planes	0.85m / 2ft 9in	1.2m / 3ft 11in
Object Dimensions at M.O.D. 1.78:1 Aspect Ratio**	19mm 917 x 516mm 90mm 193 x 109mm	25mm 937 x 527mm 300mm 77 x 43mm
Angular Field of View 1.78:1 Aspect Ratio**	19mm 71.7° x 44.2° 90mm 17.3° x 9.8°	25mm 57.5° x 34.3° 300mm 5.2° x 2.9°
Focus Rotation	200°	280°
Zoom Rotation	120°	120°
Approx. Size	Φ114 x 226mm(ΦxLength)	Φ136 x 401mm(ΦxLength)
Approx. Mass	2.8kg (with Drive Unit) / 2.3kg (without Drive Unit)	8.4Kg (without optional Drive Unit)

XK Cabrio Series



*Now Available without drive unit

Model Name	XK20-120mm T3.5
Application	35mm PL Mount Camera
Focal Length	20–120mm
Zoom Ratio	6 x
T-No.	T3.5
Compatible Image Size(diagonal)	Maximum 28.5mm
Iris Blades	9
M.O.D.from Image Planes	1.1m / 3ft 7in
Object Dimensions at M.O.D. 1.78:1 Aspect Ratio**	20mm 1109 x 624mm 120mm 182 x 102mm
Angular Field of View 1.78:1 Aspect Ratio**	20mm 63.7° x 38.5° 120mm 11.8° x 6.7°
Focus Rotation	200°
Zoom Rotation	90°
Approx. Size	Φ114 x 239mm(ΦxLength)
Approx. Mass	2.9kg (with Drive Unit) / 2.4kg (without Drive Unit)

MK Series



Model Name	MK18-55mm T2.9	MK50-135mm T2.9
Application	Super 35mm/APS-C E-mount Camera	Super 35mm/APS-C E-mount Camera
Focal Length	18-55mm	50-135mm
Zoom Ratio	3.0 x	2.7 x
T-No.	T2.9	T2.9
Compatible Image Size(diagonal)	Maximum 28.5mm	Maximum 28.5mm
Iris Blades	9	9
M.O.D.from Image Planes	0.85m/2ft 9in	1.2m/3ft 11in
Object Dimensions at M.O.D. 1.78:1 Aspect Ratio**	18mm 924mm x 520mm 55mm 291mm x 164mm	50mm 534mm x 300mm 135mm 196mm x 110mm
Angular Field of View 1.78:1 Aspect Ratio**	18mm 69.2° x 42.4° 55mm 25.5° x 14.5°	50mm 27.9° x 15.9° 135mm 10.5° x 5.9°
Focus Rotation	200°	200°
Zoom Rotation	90°	90°
Approx. Size	Φ85mm x 206mm(ΦxLength)	Φ85mm x 206mm(ΦxLength)
Approx. Mass	980g	980g

Servo Control Kit

ZK14-35mm T2.9 / ZK19-90mm T2.9 /
ZK85-300mm T2.9-4.0 / XK20-120mm T3.5

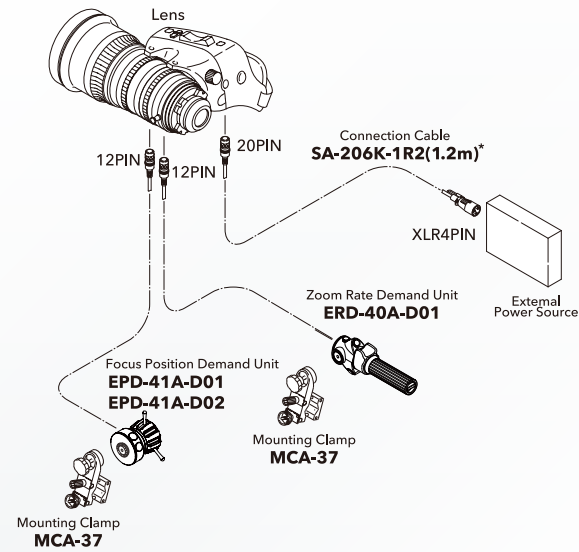

ZK25-300mm T3.5-3.85

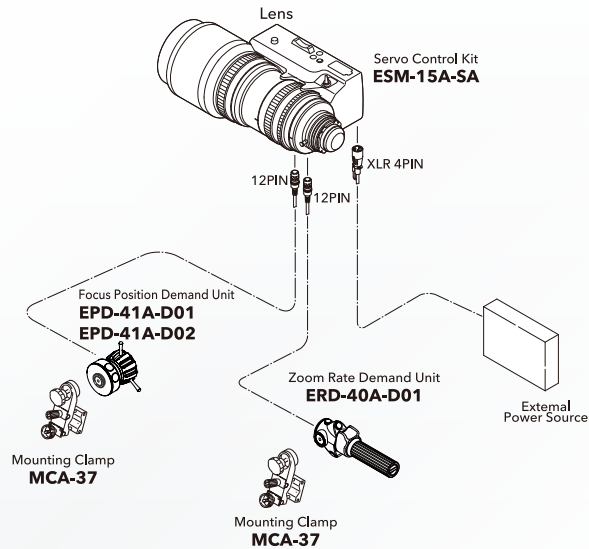

*Connection cable for external power source is necessary when the power source (over 10V, 1A) can't be supplied from a camera.

Control Accessories List

	Description	Model Name
Focus Demand	Digital Focus Position Demand	EPD-41A-D01 / D02
	Mounting Clamp	MCA-37
	Standard Focus Position Demand	EPD-21A-A01/A02
Zoom Demand	Mounting Clamp	MCA-7
	Digital Zoom Demand (Featured Iris Remote Control)	ERD-40A-D01
	Mounting Clamp	MCA-37
Other	Zoom Rate Demand Unit	ERD-20A-A02
	Mounting Clamp	MCA-7
	Lens Hood for ZK4.7x19, ZK3.5x85	HS-304A-114
	Lens Hood for ZK2.5x14	HS-304B-114
	Digital Servo Module (Designed for ZK12x25)	ESM-15A-SA
	Power Source Cable (Lens:20pin - XLR4pin), L=120cm	SA-206K-1R2
Power Source Cable (Lens:20pin - Camera:12pin), L=120cm	SA-206M-1R2	
Power Source Cable (Lens:20pin - Camera:12pin), L=40cm	SA-206M-R40	

FUJINON Lens Maintenance

Maintaining high performance levels far into the future

Lens Cleaning

Use commonly available lens cleaner and lens cleaning paper.



First, remove the lens cover and brush the dust from the lens surface with a soft brush or blower brush.

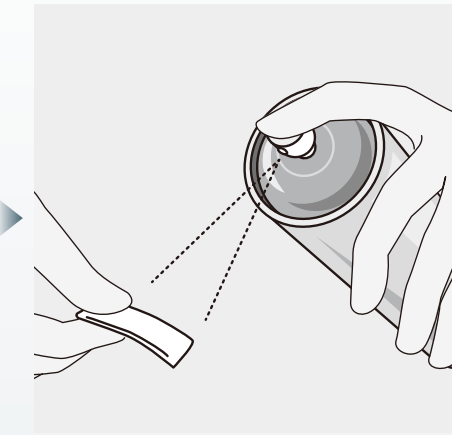

Fold the lens paper into an appropriate size and moisten a part of it with lens cleaner.

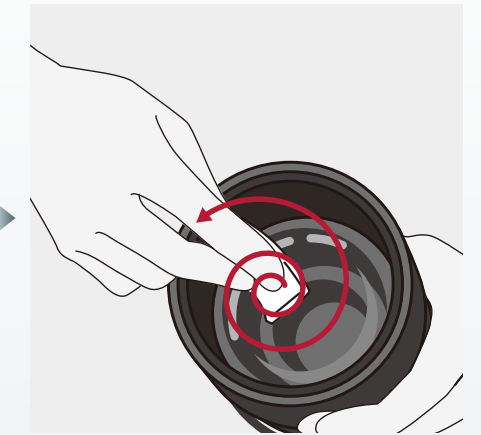

Gently wipe the lens with the moistened lens paper in a circular motion, from the center to the edges. Take a dry piece of lens paper and wipe until all smears disappear.

Moisture Removal

If water seeps through to the inner part of the lens, quickly wipe all remaining water on the outer part of the lens with a dry cloth. Next, place the lens into a sealable vinyl bag with a drying agent, seal the bag and allow to completely dehumidify.

Storage

If the lens will not be used for some time, please store it away from high temperatures, high humidity and corrosive gases. High temperatures and high humidity are particular causes of mold. Mold is able to thrive in temperatures of between 20-28°C and between 60-80% humidity levels.

Caution

The lens consists of an optical unit and a power unit. Both units are held in place with screws. Please DO NOT unscrew the units. If the units are separated, the mechanism of the power unit will require realignment.

If you encounter any problems during use,
please contact your sales representative or our Service Center.

We recommend that lenses be inspected on a regular basis at least once a year to maintain high performance over the long term.

