

GigaCore Range

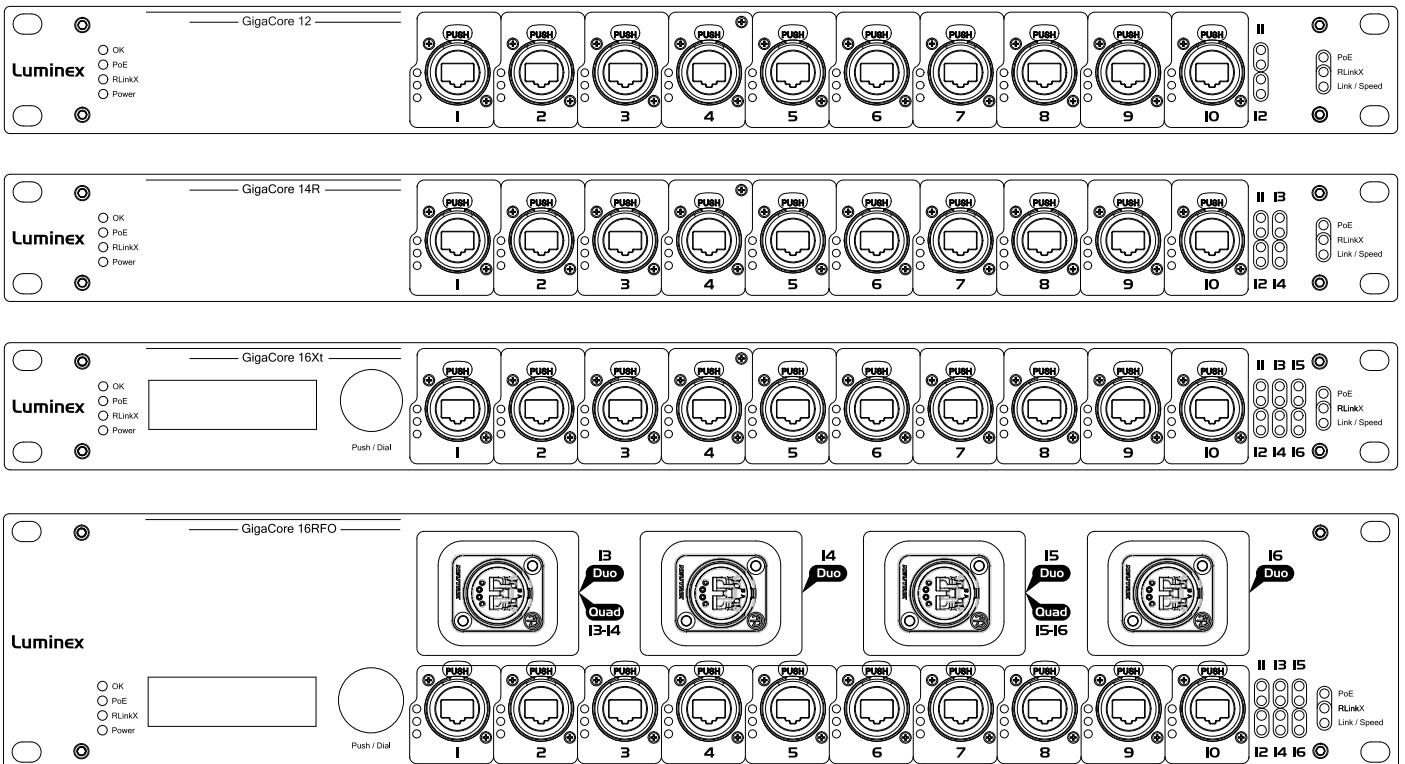

Gigabit Managed AV Ethernet Switch

User Manual

V 2.4.0

Rev 2

English

Safety Instructions



The lightning flash with arrowhead symbol, within an equilateral triangle, is intended to alert the user to the presence of uninsulated "dangerous voltage" within the product's enclosure that may be of sufficient magnitude to constitute a risk of electric shock to persons.

L'éclair avec une flèche à l'intérieur d'un triangle équilatéral est destiné à attirer l'attention de l'utilisateur sur la présence d'une « tension dangereuse » non isolée à l'intérieur de l'appareil, pouvant être suffisamment élevée pour constituer un risque d'électrocution.



The exclamation point within an equilateral triangle is intended to alert the user to the presence of important operating and maintenance (servicing) instructions in the literature accompanying the appliance.

Le point d'exclamation à l'intérieur d'un triangle équilatéral est destiné à attirer l'attention de l'utilisateur sur la présence d'instructions importantes sur l'emploi ou la maintenance (réparation) de l'appareil dans la documentation fournie.

CAUTION

TO REDUCE THE RISK OF FIRE OR ELECTRIC SHOCK, DO NOT EXPOSE THIS APPARATUS TO RAIN OR MOISTURE.

AVERTISSEMENT

POUR RÉDUIRE LES RISQUES D'INCENDIE OU DE DÉCHARGE ÉLECTRIQUE, N'EXPOSEZ PAS CET APPAREIL À LA PLUIE OU À L'HUMIDITÉ.

CAUTION

NO USER SERVICEABLE PARTS INSIDE. REFER SERVICING TO QUALIFIED SERVICE PERSONEL.

AVERTISSEMENT

AUCUNE PIÈCE CONTENUE A L'INTÉRIEUR NE PEUT ÊTRE RÉPARÉE PAR L'UTILISATEUR, VEUILLEZ CONFIER TOUTE RÉPARATION À UN PERSONNEL QUALIFIÉ.

IMPORTANT SAFETY INSTRUCTIONS

- Read these instructions.
- Keep these instructions.
- Heed all warnings.
- Follow all instructions.
- Do not use this apparatus near water.
- Clean only with dry cloth.
- Do not block any ventilation openings. Install in accordance with the manufacturer's instructions.
- Do not install near any heat sources such as radiators, heat registers, stoves, or other apparatus (including amplifiers) that produce heat.
- Protect the power cord from being walked on or pinched particularly at plugs, convenience receptacles, and the point where they exit from the apparatus.
- Only use attachments/accessories specified by the manufacturer.
- Unplug this apparatus during lightning storms or when unused for long periods of time.
- Refer all servicing to qualified service personnel. Servicing is required when the apparatus has been damaged in any way, such as power-supply cord or plug is damaged, liquid has been spilled or objects have fallen into the apparatus, the apparatus has been exposed to rain or moisture, does not operate normally, or has been dropped.

PRÉCAUTIONS CONCERNANT LA SÉCURITÉ

- Lire ces instructions.
- Conserver ces instructions.
- Tenir compte de tous les avertissements.
- Suivre toutes les instructions.
- Ne pas utiliser ce produit à proximité d'eau.
- Nettoyer uniquement avec un chiffon propre et sec.
- Ne pas bloquer les orifices de ventilation. Installer l'appareil conformément aux instructions du fabricant.
- Ne pas installer l'appareil à proximité d'une source de chaleur comme un radiateur, une bouche de chaleur, un poêle ou tout autre appareil (y compris un amplificateur) produisant de la chaleur.
- Acheminer les cordons d'alimentation de sorte qu'ils ne soient pas piétinés ni coincés, en faisant tout spécialement attention aux fiches, prises de courant et au point de sortie de l'appareil.
- Utiliser exclusivement les fixations et accessoires spécifiés par le fabricant.
- Débrancher l'appareil en cas d'orage ou lorsqu'il doit rester hors service pendant une période prolongée.
- Confier toute réparation à un personnel qualifié. Faire réparer l'appareil s'il a subi tout dommage, par exemple si la fiche ou le cordon d'alimentation est endommagé, si du liquide a coulé ou des objets sont tombés à l'intérieur de l'appareil, si l'appareil a été exposé à la pluie ou à de l'humidité, si l'appareil ne fonctionne pas normalement ou est tombé.

THIS APPARATUS MUST BE EARTHED



WARNING: Avoid electric shock and fire hazard! Do not defeat the safety purpose of the polarized or grounding-type plug. A polarized plug has two blades with one wider than the other. A grounding type plug has two blades and a third grounding prong. The wide blade or the third prong are provided for your safety. If the provided plug does not fit into your outlet, consult an electrician for replacement of the obsolete outlet.



CET APPAREIL DOIT ÊTRE RELIÉ À LA TERRE

AVERTISSEMENT: Evitez les décharges électriques et les risques d'incendie. Ne pas modifier le système de sécurité de la fiche polarisée ou de la fiche de terre. Une fiche polarisée dispose de deux broches dont une est plus large que l'autre. Une fiche de terre dispose de deux broches et d'une troisième pour le raccordement à la terre. Cette broche plus large ou cette troisième broche est destinée à assurer la sécurité de l'utilisateur. Si la fiche équipant l'appareil n'est pas compatible avec les prises de courant disponibles, faire remplacer les prises par un électricien.

THIS APPARATUS MUST BE EARTHED



SWEDEN: Apparaten skall anslutas till jordat uttag

NORWAY: Apparatet må tilkoples jordet stikkontakt

FINLAND: Laite on liitettävä suojamaadoituskoskettimillavarustettuun pistorasiaan

DENMARK: Apparatets stikprop skal tilsluttes en stikkontakt med jord, som giver forbindelse til stikproppens jord

VENTILATION OPENINGS:

The system heat vents located on each side dissipate heat. Do not block these openings. Leave at least 5 inches of space at the rear and 2 inches of space at the sides of the switch for proper ventilation. Be reminded that without proper heat dissipation and air circulation, system components might overheat, which could lead to system failure or even severely damage components.

WARNING: To prevent the Gigacore switch from overheating, do not operate it in an area that exceeds the maximum recommended ambient temperature of 50°C.

POWER CABLE:

Use only approved power cables. If you have not been provided with a power cable for your system or for any AC powered option intended for your system, purchase a power cable that is approved for use in your country. The power cable must be rated for the product and for the voltage and current marked on the product's electrical ratings label. The voltage and current rating of the cable should be greater than the ratings marked on the product.

DISCONNECT DEVICE:

The plug- IEC socket or the Powercon TrueONE Male-female combinations must be accessible at all times, because it serves as the main disconnecting device.

Disposal of Waste Equipment by users in the European Union

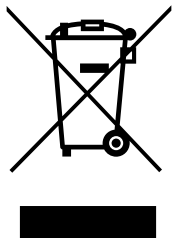

This symbol on the product or its packaging indicates that this product must not be disposed of with other waste. Instead, it is your responsibility to dispose of your waste equipment by handing it over to a designated collection point for the recycling of waste electrical and electronic equipment. The separate collection and recycling of your waste equipment at the time of disposal will help conserve natural resources and ensure that it is recycled in a manner that protects human health and the environment. For more information about where you can drop off your waste equipment for recycling, please contact your local city recycling office or the dealer from whom you purchased the product.

EMC (Electromagnetic Compliance)

The models GigaCore 12, GigaCore 14R and GigaCore 16Xt comply with the following standards regulating interference and EMC:

- EN 55103-1, environment E2
- EN 55103-2, environment E2

CE Compliance (EMC and Safety)



Luminex is authorized to apply the CE mark on this compliant equipment thereby declaring conformity to EMC Directive 2004/108/EC and Low Voltage Directive 2006/95/EC.

Warranty information

Limited warranty

Unless otherwise stated, your product is covered by a two (2) years parts and labor limited warranty. It is the owner's responsibility to furnish receipts or invoices for verification of purchase, date, and dealer or distributor. If purchase date cannot be provided, date of manufacture will be used to determine warranty period.

Returning under warranty

Any Product unit or parts returned to Luminex LCE must be packaged in a suitable manner to ensure the protection of such product unit or parts, and such package shall be clearly and prominently marked to indicate that the package contains returned product units or parts. Accompany all returned product units or parts with a written explanation of the alleged problem or malfunction.

Freight

All shipping will be paid by the purchaser. Items under warranty shall have return shipping paid by the manufacturer only in the European Union.

Under no circumstances will freight collect shipments be accepted. Prepaid shipping does not include rush expediting such as air freight. Air freight can be sent customer collect in the European Union.

Warranty is void if the product is misused, damaged, modified in any way, or for unauthorized repairs or parts.

Registration

Use your favorite web browser, and visit <http://www.luminex.be/support.php?show=registration> to register your product online.

By registering, you become eligible to receive the following:

- Technical support information
- Software update and upgrade notices
- Hardware warranty information

In the box

1 x GigaCore Ethernet switch

1 x Quick Start Guide (including warranty information and safety instructions).

Table of Content

■	Safety Instructions	2
■	Compliance information	4
■	Disposal of Waste Equipment by users in the European Union	4
■	EMC (Electromagnetic Compliance)	4
■	CE Compliance (EMC and Safety)	4
■	Warranty information	5
■	Limited warranty	5
■	Returning under warranty	5
■	Freight	5
■	Registration	5
■	In the box	5
■	FCC Compliance for the United States of America	7
■	Description	8
■	Front panel (GigaCore 12)	8
■	Rear panel (GigaCore 12)	9
■	Front panel (GigaCore 14R)	10
■	Rear panel (GigaCore 14R)	11
■	Front panel (GigaCore 16Xt)	12
■	Rear panel (GigaCore 16Xt)	13
■	Front panel (GigaCore 16RFO)	14
■	Rear panel (GigaCore 16RFO)	15
■	Led indicators	16
■	Power	16
■	Installing Mini GBIC (SFP) transceivers (14R and 16Xt only)	17
■	Connecting the Redundant Power Supply Unit (14R and 16xt only)	18
■	GigaCore features explained	19
■	RLinkX	19
■	Groups	20
■	MultiLinkX	21
■	Front end display (16Xt and RFO only)	23

■	Starting	24
■	Connection to the web interface	24
■	Status Page	25
■	Global Page	26
■	RLinkX	30
■	Groups	31
■	MultiLinkX	33
■	PoE	34
■	Profile Manager	36
■	Reset the unit	40
■	Reset	40
■	Reload Default	41
■	Factory Reset	41
■	Specifications	42
■	Additional documentation	44

Description

Front panel (GigaCore 12)

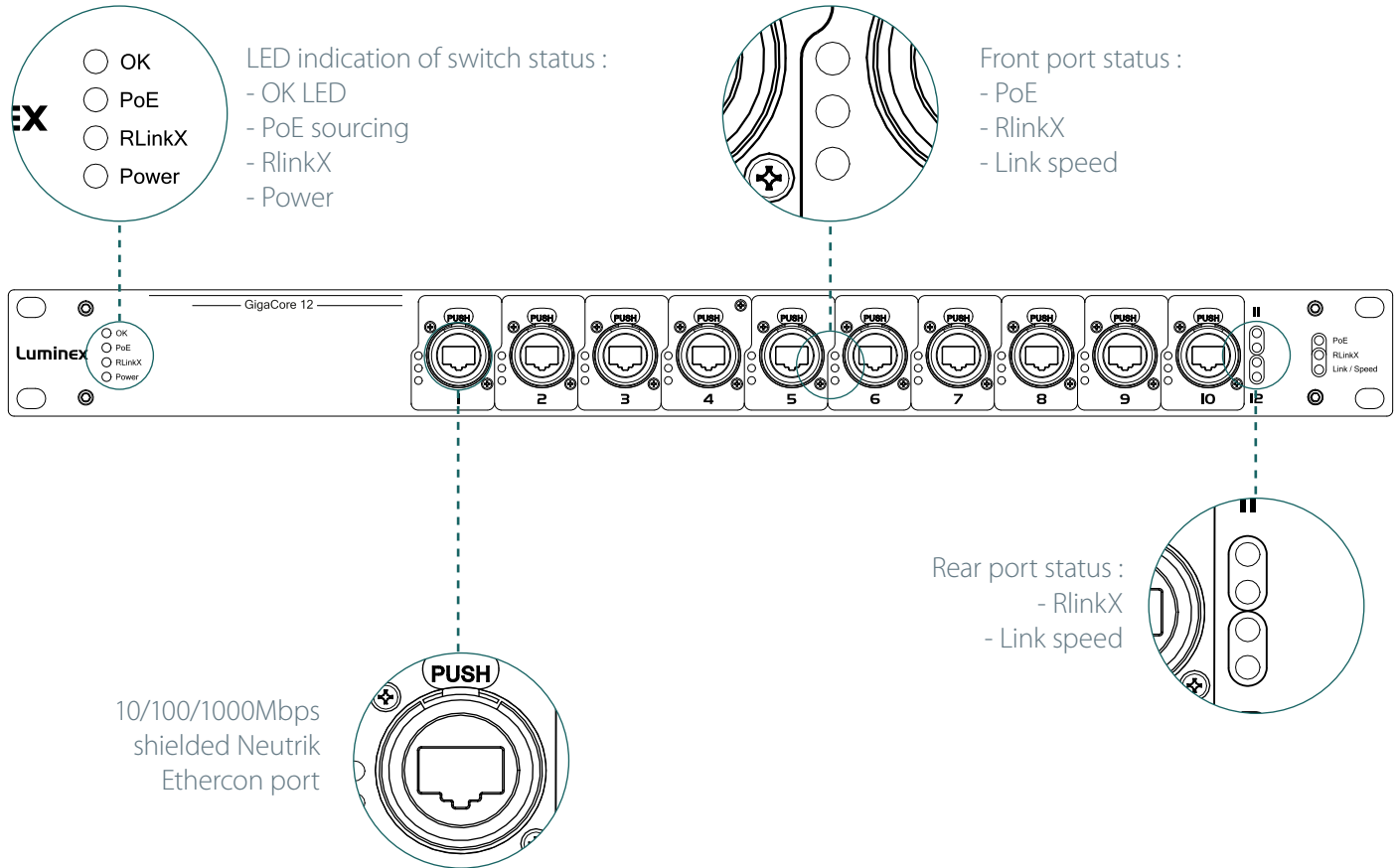

- 10 x 10/100/1000Mbps shielded Neutrik Ethercon connector
- 4 x LED for switch status
- 3 x LED per port for Ethercon front port status
- 2 x LED per port for Ethercon rear port status

Rear panel (GigaCore 12)

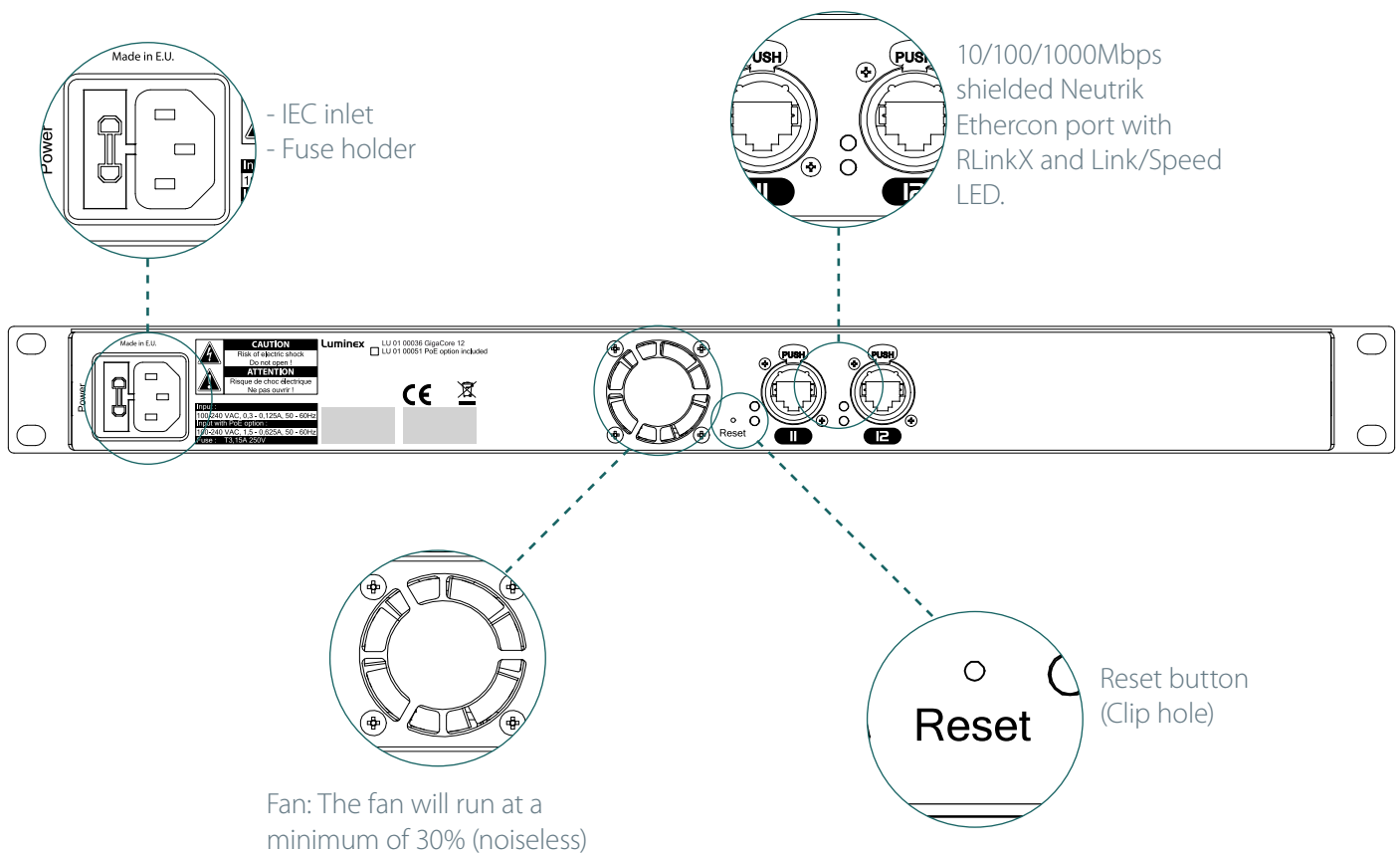

- 2 x 10/100/1000Mbps shielded Neutrik Ethercon connector
- 2 x LED per port for Ethercon port status
- 1 x Fan
- 1 x IEC inlet + Fuse holder
- 1 x Reset button (clip hole)

Front panel (GigaCore 14R)

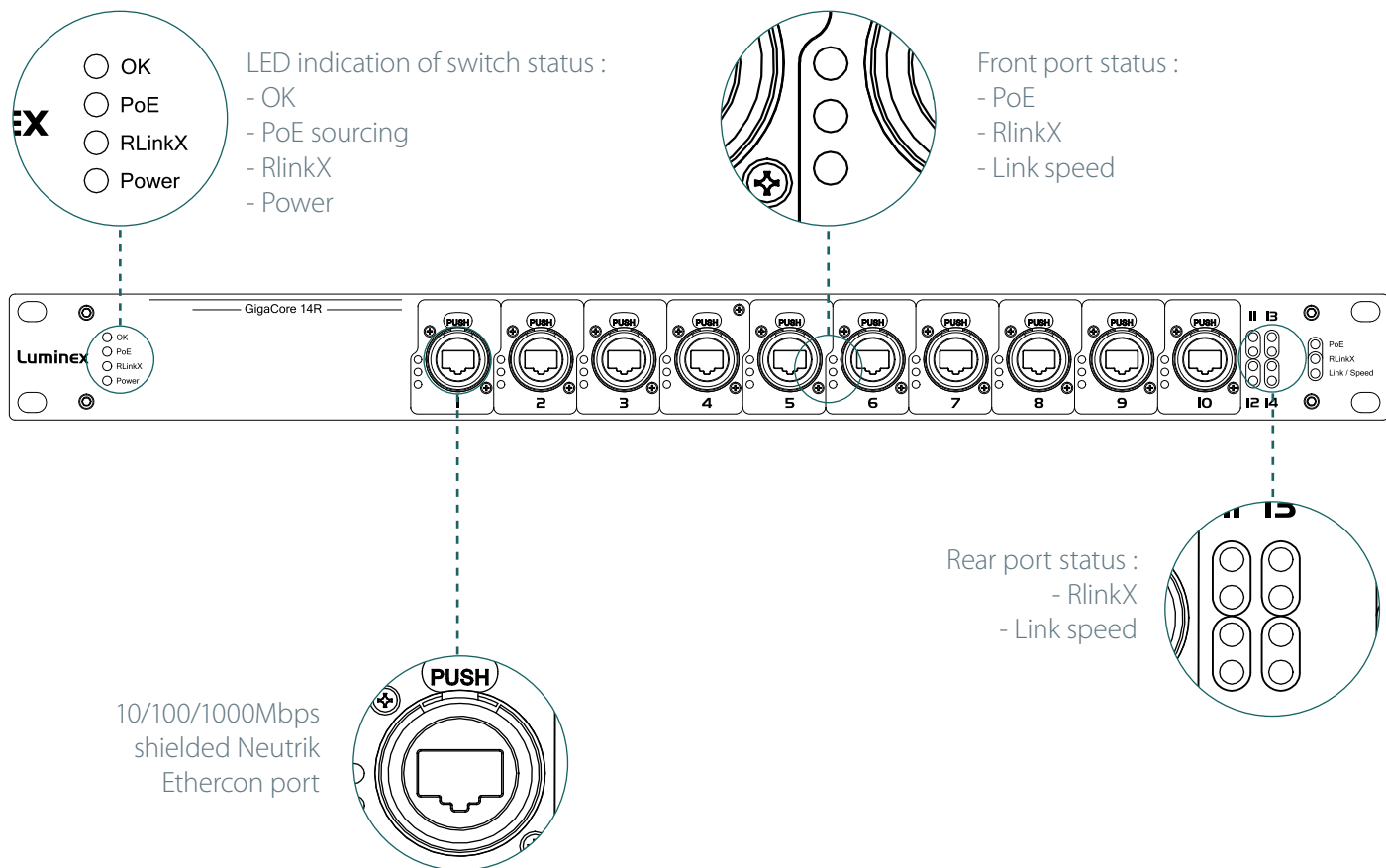

- 10 x 10/100/1000Mbps shielded Neutrik Ethercon connector
- 4 x LED for switch status
- 3 x LED per port for Ethercon front port status
- 2 x LED per port for Ethercon and fiber rear port status

Rear panel (GigaCore 14R)

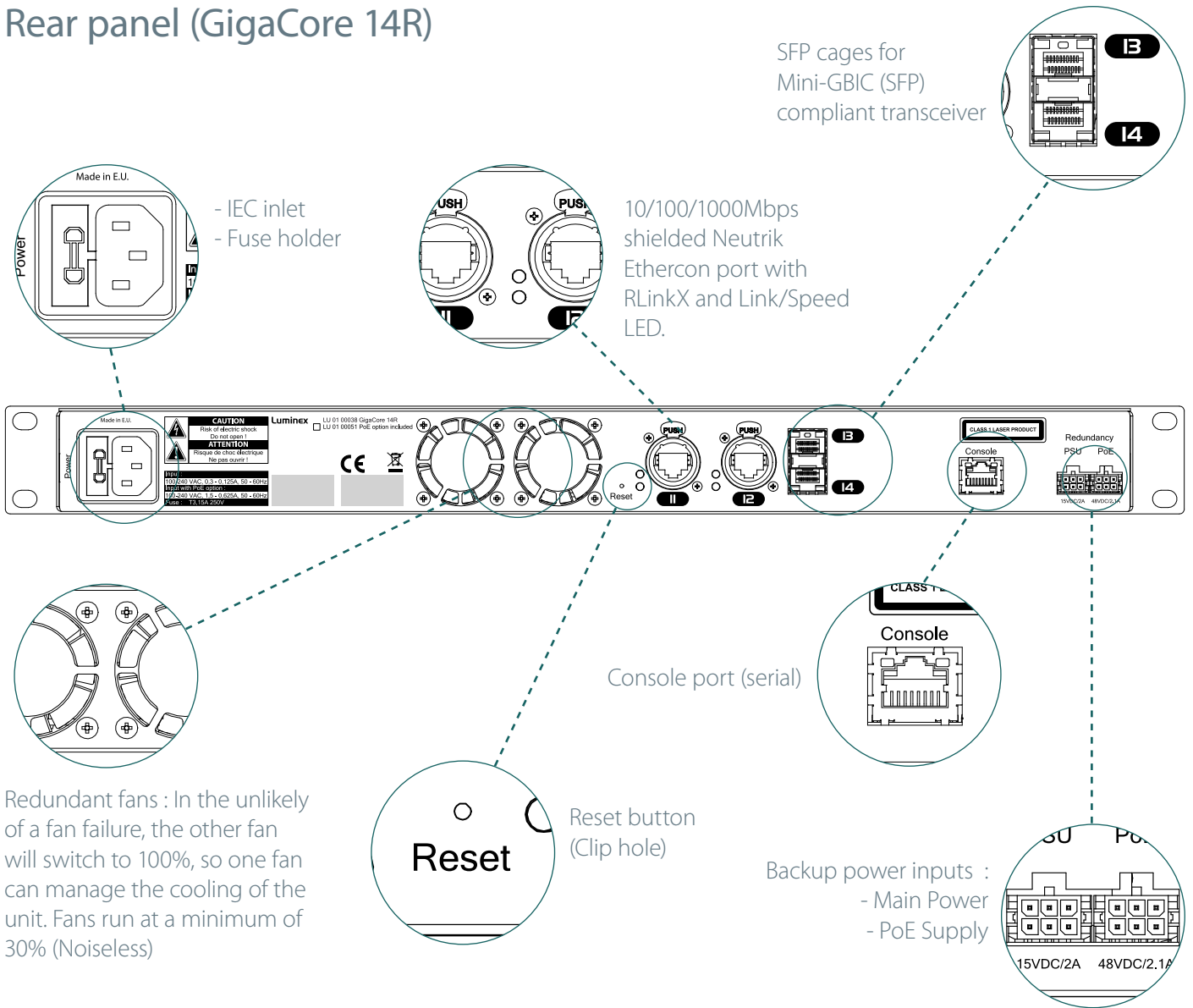

Redundant fans : In the unlikely of a fan failure, the other fan will switch to 100%, so one fan can manage the cooling of the unit. Fans run at a minimum of 30% (Noiseless)

- 2 x 10/100/1000Mbps shielded Neutrik Ethercon connector
- 2 x LED per port for Ethercon port status
- 2 x SFP cage for Mini-Gbic compliant transceiver
- 1 x Serial console port on RJ45
- 1 x Mollex Micro-fit 6 pin connector for backup power supply input
- 1 x Mollex Micro-fit 6 pin connector for backup PoE supply input
- 2 x Redundant fan
- 1 x IEC inlet + Fuse holder
- 1 x Reset button (clip hole)

Front panel (GigaCore 16Xt)

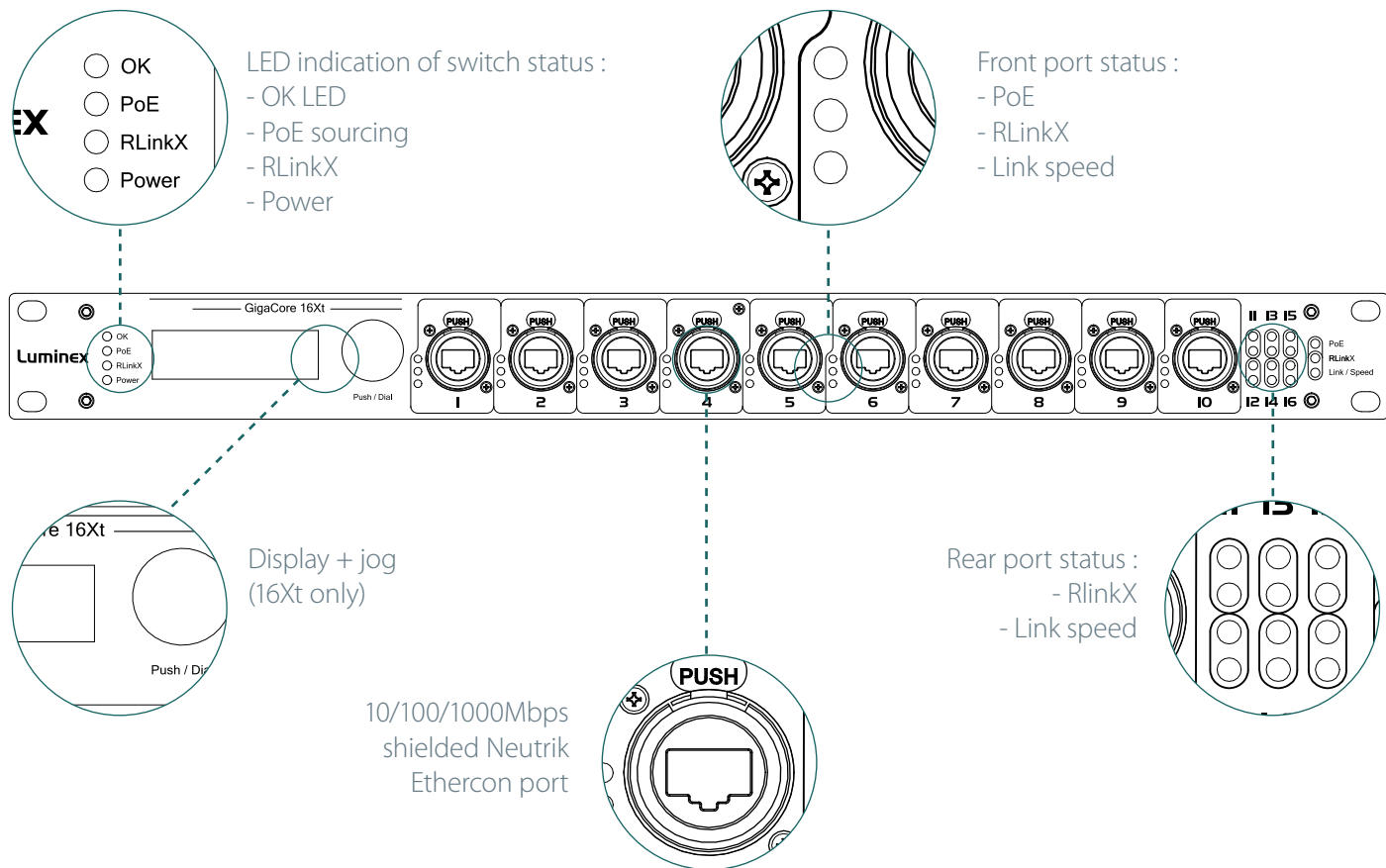

- 10 x 10/100/1000Mbps shielded Neutrik Ethercon connector
- 4 x LED for switch status
- 3 x LED per port for Ethercon front port status
- 2 x LED per port for Ethercon rear port status
- 1 x display (16Xt only)
- 1 x Jog (16Xt only)

Rear panel (GigaCore 16Xt)

SFP cages for Mini-GBIC (SFP) compliant transceiver (14R and 16Xt only)

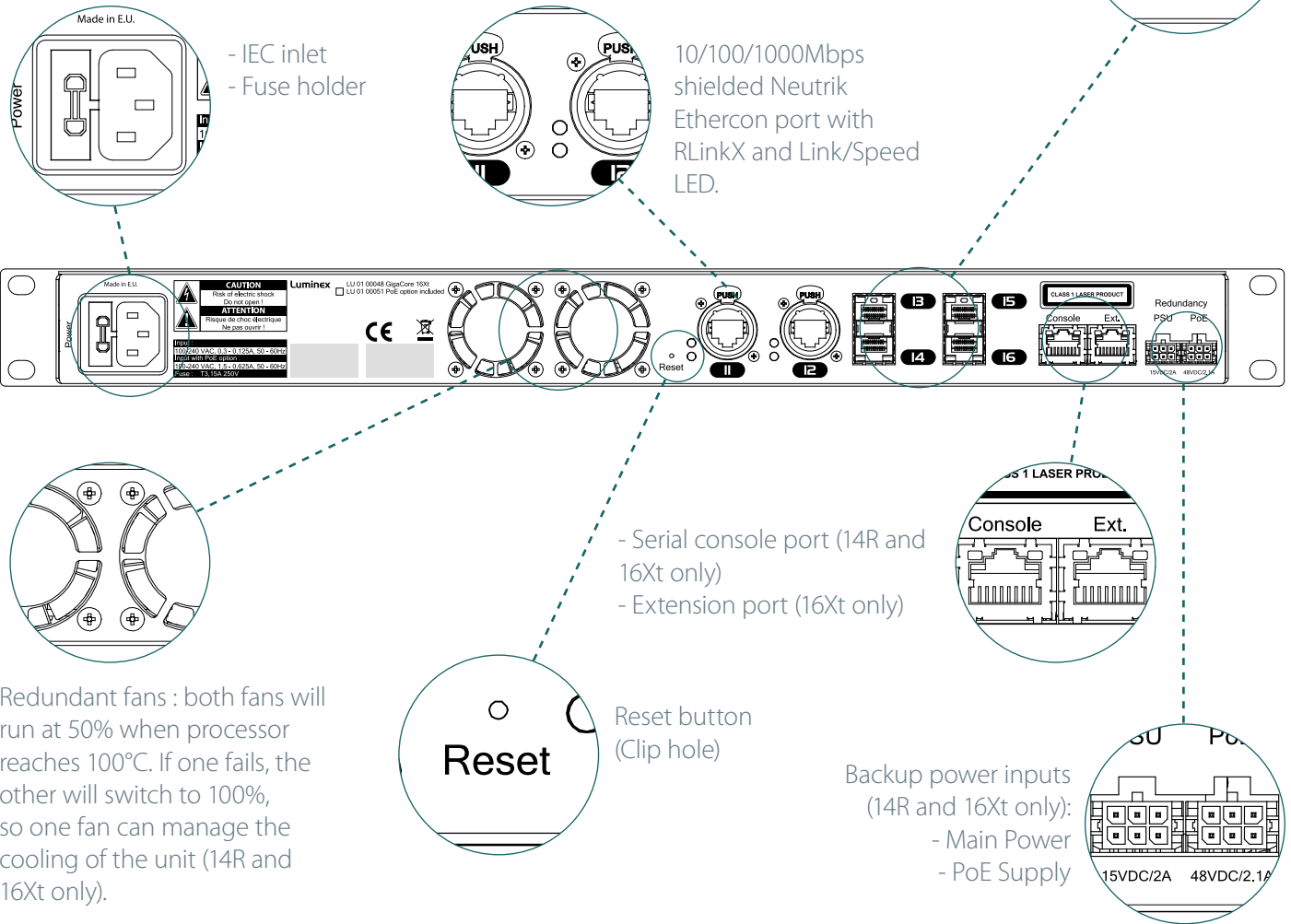

Redundant fans : both fans will run at 50% when processor reaches 100°C. If one fails, the other will switch to 100%, so one fan can manage the cooling of the unit (14R and 16Xt only).

- 2 x 10/100/1000Mbps shielded Neutrik Ethercon connector
- 2 x LED per port for Ethercon port status
- 2 x SFP cage for Mini-Gbic compliant transceiver (14R only)
- 4 x SFP cage for Mini-Gbic compliant transceiver (16Xt only)
- 1 x Serial console port on RJ45 (14R and 16Xt only)
- 1 x I2C Extension port on RJ45 (16Xt only)
- 1 x Mollex Micro-fit 6 pin connector for backup power supply input (14R and 16Xt only)
- 1 x Mollex Micro-fit 6 pin connector for backup PoE supply input (14R and 16Xt only)
- 2 x Redundant fan (14R and 16Xt only)
- 1 x IEC inlet + Fuse holder
- 1 x Reset button (clip hole)

Front panel (GigaCore 16RFO)

The GigaCore 16RFO offers several different fibre port configuration. Your configuration may differ from the one detailed below. This configuration is used as a reference only.

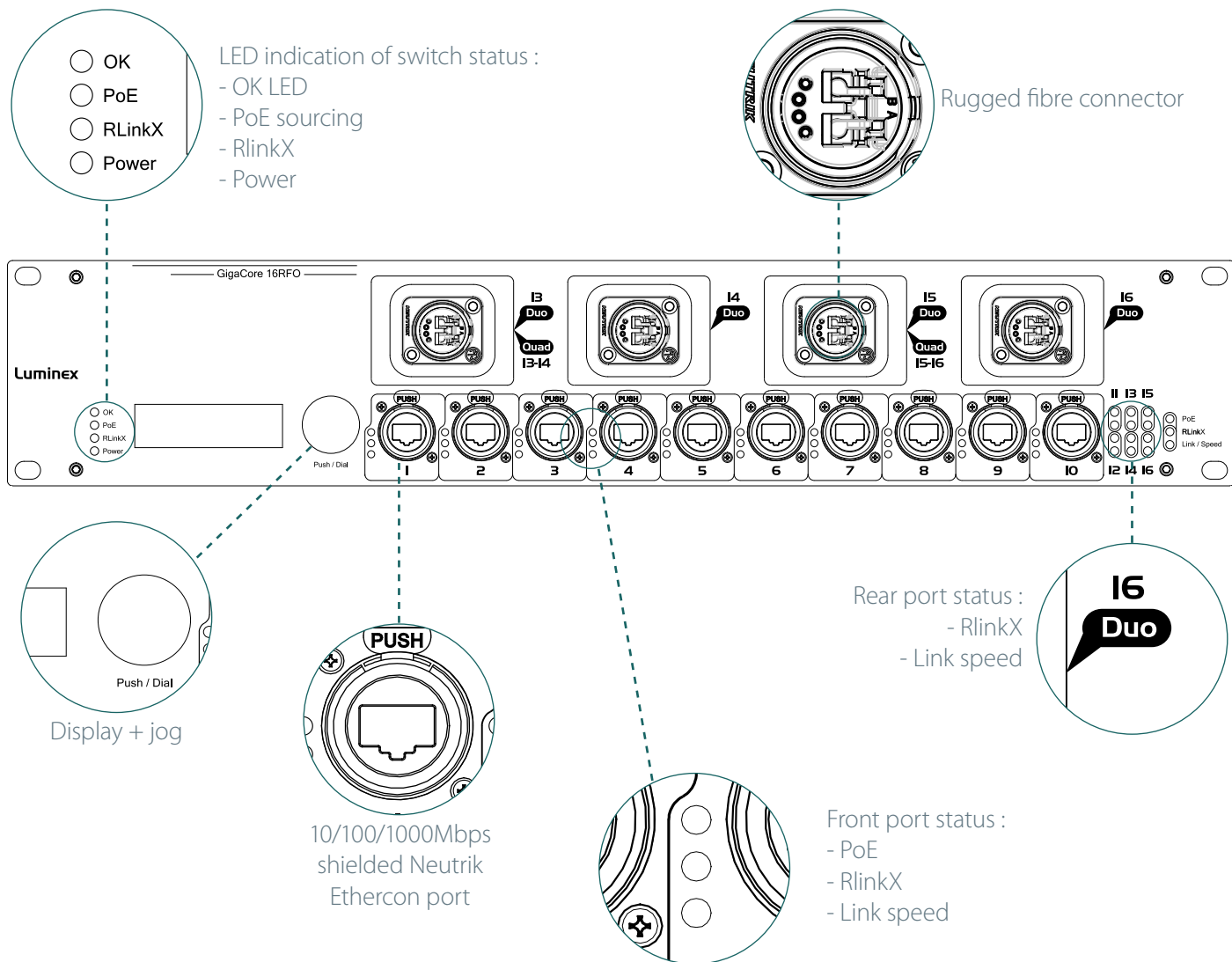

- 10 x 10/100/1000Mbps shielded Neutrik Ethercon connector
- 4 x slots for D type rugged fibre connectors
- 4 x LED for switch status
- 3 x LED per port for Ethercon front port status
- 2 x LED per port for Ethercon and fiber port status
- 1 x display
- 1 x Jog

Rear panel (GigaCore 16RFO)

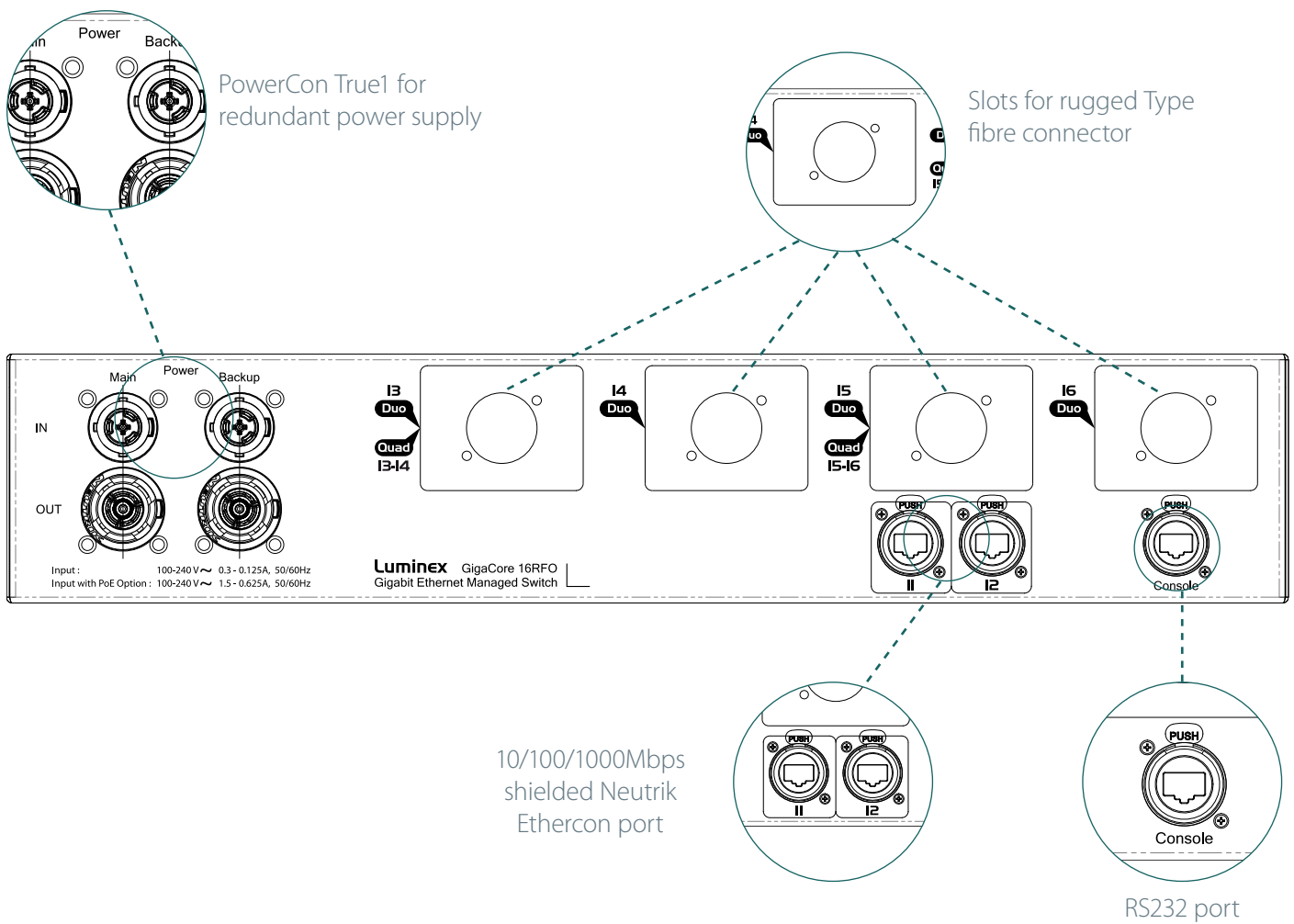

- 2 x 10/100/1000Mbps shielded Neutrik Ethercon connector
- 4 x slots for D type rugged fibre connectors
- 1 x Serial console port on RJ45
- 2 x Redundant fan (on the side of the unit). In the unlikely of a fan failure, the other fan will switch to 100%, so one fan can manage the cooling of the unit. Fans run at a minimum of 30%
- 2 x Neutrik PowerCon True1 IN/OUT connector

Led indicators

The LED indicators of the GigaCore switch include status, Poe, RlinkX, power, link/speed. The following shows the LED indicators for the GigaCore switch along with an explanation of each indicator.

Switch LED	Status	Meaning
OK (General status LED)	Green	All Ok
	Green blink	Unit is writing to the flash. Do not disconnect power
	Orange	Temperature warning
	Red blink	Temperature or fan error
	Red/Green blink	The unit is flashing new firmware. Do not disconnect power
PoE LED	Off	No PoE
	Green	Internal PoE supply OK and RPSU connected. PoE functionality OK
	Orange	Internal PoE supply OK (no RPSU connected) - PoE functionality OK
	Red blink	PoE supply or PoE functionality error
RlinkX LED	Green	RLinkX is active
Power LED	Green	Internal Power supply OK and RPSU connected
	Orange	Internal power supply OK (no RPSU connected)
	Red blink	Power error
Port LED	Status	Meaning
PoE LED	Orange	Sourcing
	Off	Not sourcing
RlinkX LED	Blue	Redundant port / link
Link	Off	No link
	Green	Gigabit connection
	Orange	10/100 Mbps connection
	Blink	Activity

Power

The device operates with an AC voltage between 100V and 240VAC within a frequency range of 50Hz to 60Hz. An IEC socket (GigaCore 12, 14R and 16Xt) is located at the rear of the unit. Please use an IEC plug compliant cable to feed power to the unit.

Luminex recommends the use of a power cable, fitted with a locking mechanism to ensure a reliable connection to the device. Luminex also recommends to use power cable in accordance with the standards and the relevant authorities of your country.

The GigaCore 16RFO comes with a Neutrik PowerCon TrueOne connector for both main and backup power supply.



!!! WARNING: TO ENSURE A TOTAL PROTECTION, THIS EQUIPMENT MUST BE EARTHED !!!

Connect the power cable to the device, and connect the other side of the cable to the mains. It will take around 20 seconds for the switch to boot up. You can then use the apparatus.

Installing Mini GBIC (SFP) transceivers (I4R and I6Xt only)

The GigaCore 14R and 16Xt comes with up to four SFP cages at the rear of the unit. These cages accept mini GBIC transceivers. Check our web site for more information about available transceivers.

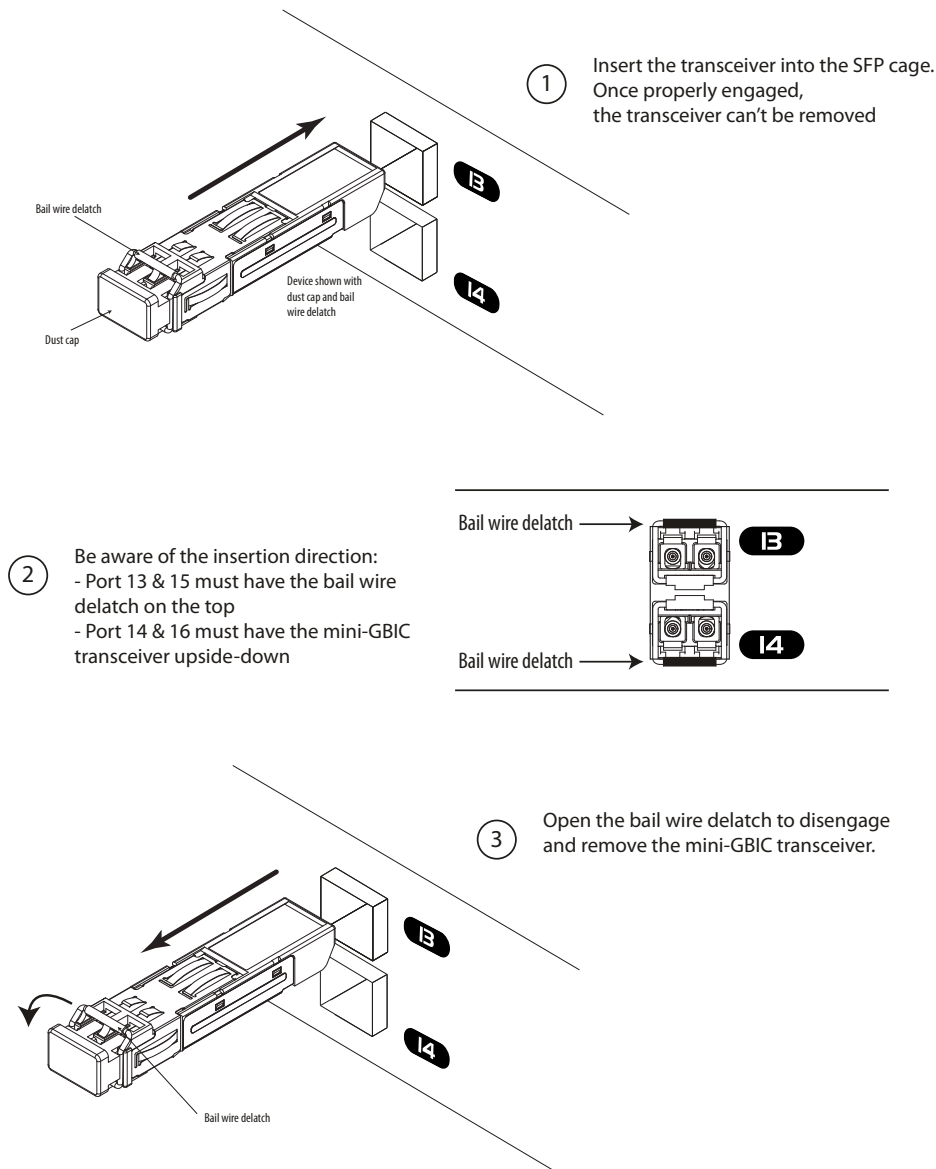

For any other model of mini-GBIC transceiver, please refer to the transceiver manual.

Recommended transceivers

In order to get best the performances, Luminex recommends the use of the following transceivers:

- LU 90 00871 GigaCore 1.25Gd Multi-Mode fiber transceiver
- LU 90 00872 GigaCore 1.25Gd Single Mode fiber transceiver
- LU 90 00874 GigaCore 1.25Gd copper RJ45 transceiver

Connecting the Redundant Power Supply Unit (14R and 16xt only)

The GigaCore 14R and 16xt provide a connector to an optional Luminex Redundant Power Supply Unit, providing redundancy on power level for both the mains as the PoE power.

Attach only the following RPSU to the RPSU connector: LU 01 00054 GigaCore RPSU.

Please only use the Luminex cable to connect the RPSU to the GigaCore switch.



THIS UNIT HAS MORE THAN ONE POWER SUPPLY. DISCONNECT ALL POWER SUPPLIES BEFORE SERVICING TO AVOID ELECTRIC SHOCK.

Connect the power cable to the device, and connect the other side of the cable to the mains. It will take approximately 20 seconds for the switch to boot up. You'll then be able to use it.

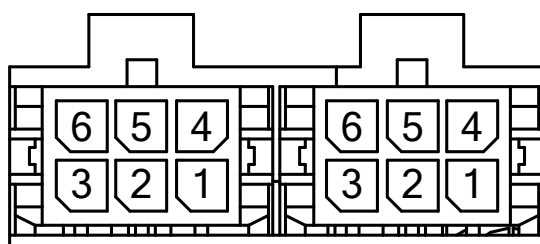

15VDC/2A 48VDC/2.1A

Pin	15VDC / 2A	48VDC / 2.1A
1	Ground	Ground
2	N.C	+48VDC
3	+15VDC	N.C
4	Ground	Ground
5	N.C	+48VDC
6	+15VDC	N.C

GigaCore features explained

The GigaCore range of switches offers a bunch of unique features which greatly simplify your everyday job. These features will be explained in the following pages :

RLinkX

RLinkX, which stands for **Redundant Link** by Lumine**X**, is an automated system to easily create redundant paths between your GigaCore switches. Switches automatically create active and backup paths, providing an effortless method to create safe networks.

If one of the active paths fails, the switches will enable a backup path, in a seamless manner.

By default, all GigaCore ports have RLinkX enabled, which means you can interconnect any GigaCore switch between each other. All redundant paths will be created automatically by the switches, no need for configuration.

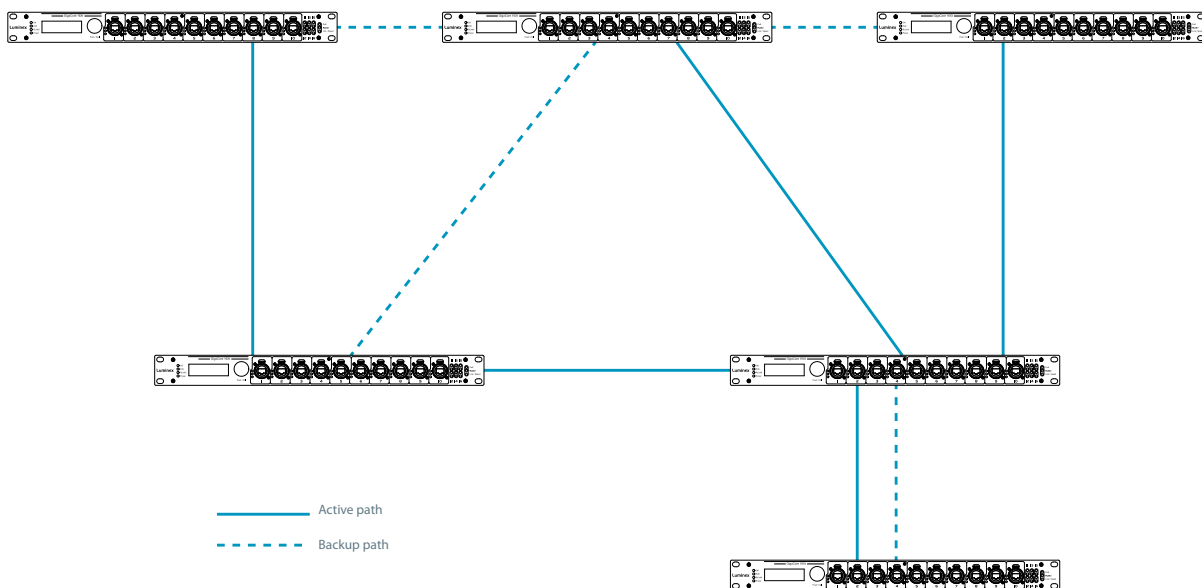

To create redundant paths with RLinkX, simply connect a minimum of two links between two GigaCore switches. The blue RLinkX LEDs of the connected ports will turn on, indicating the redundancy is active and available. If you port's RLinkX LED turns off, this means you lost one of your redundant path.

Step 1

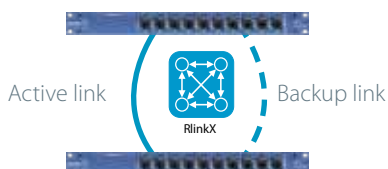

User connect two switches with two links. The switches automatically create a backup link.

Step 2

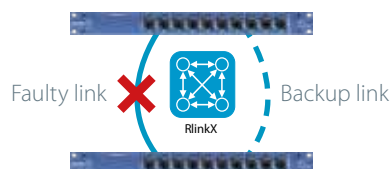

Active link becomes unavailable (cable or fibre issue)



20 to 40ms

Step 3

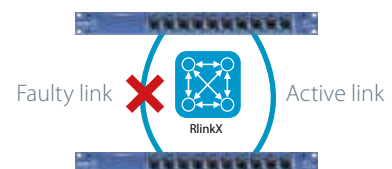

Backup link becomes active automatically

Groups

Groups function allows the user to segment the network into several subnets. The main benefit of this function is that no subnet will affect the other ones, on protocol side.

The user can create several groups on the network, and each device included in a group will be able to communicate with devices of this group only. This will result in a better bandwidth usage, and no protocol conflict.

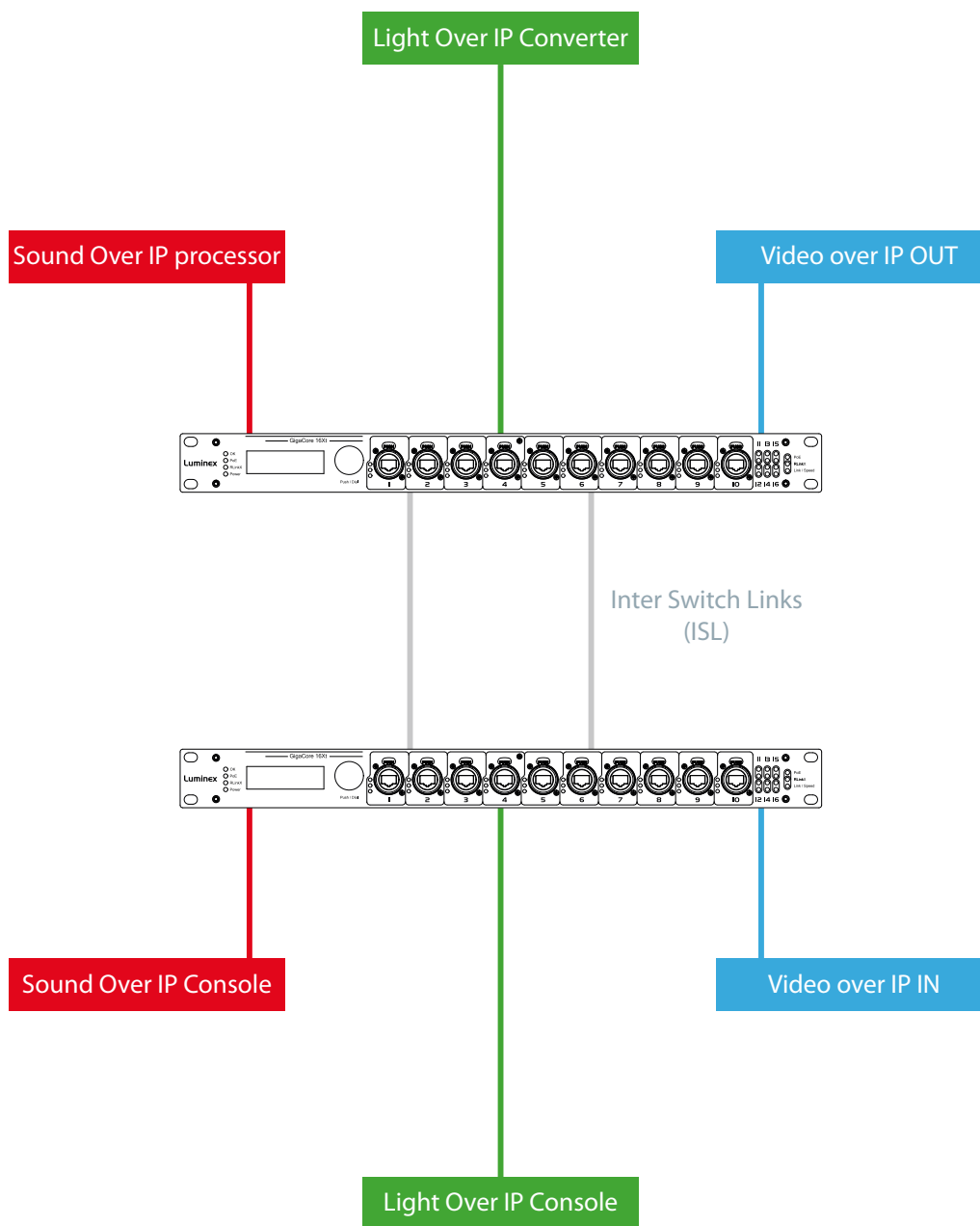

Three groups have been created in the above illustration: Red, Green and Blue groups. Each device included in each group can communicate with devices from the same group. Thus, the sound console and the sound processor can talk to each other, without being flooded by packets streamed by the two other groups.

The GigaCore switches offer 20 groups, to which the user can assign any of the ports. Two devices must be part of the same group to communicate.

When more than one switch is used in a group based network, the Inter Switch Link group (ISL Group 0) must be used to forward the group's packets between switches.

MultiLinkX

Most of the time, a redundant link set with RLinkX between two GigaCore switches will fit for every day event. A 1000Mbps link is more than enough for most of the current applications. However, it can happen that you'll need to transfer a larger amount of data between the switches.

Below is an example where four video transmitters will need to transmit four streams to each dedicated receiver. Each stream requires a throughput of 400Mbps, which represents 1600Mbps in total.

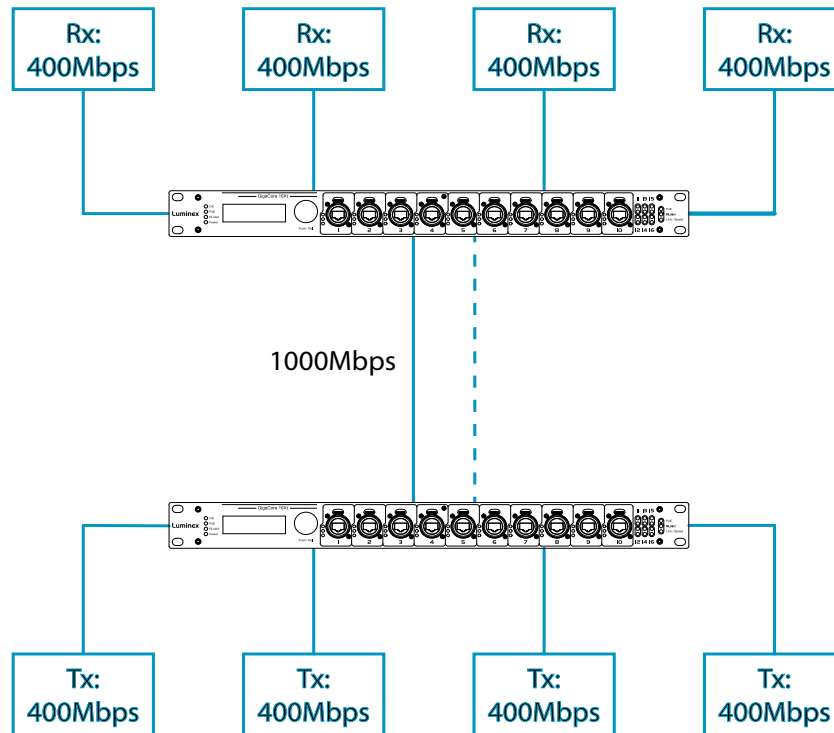

However, one link only is active between the switches, as the other link is used in case of link failure. So a maximum of 1000Mbps data transfer can be achieved on this link. In the above example, we need 1600Mbps of throughput to transfer all four video streams between the switches. This is not enough, the link between the switches will create a bottleneck, resulting in data loss or data delay. The video streams won't be delivered in time, and will create lag in the video output.

The solution? **MultiLinkX** !

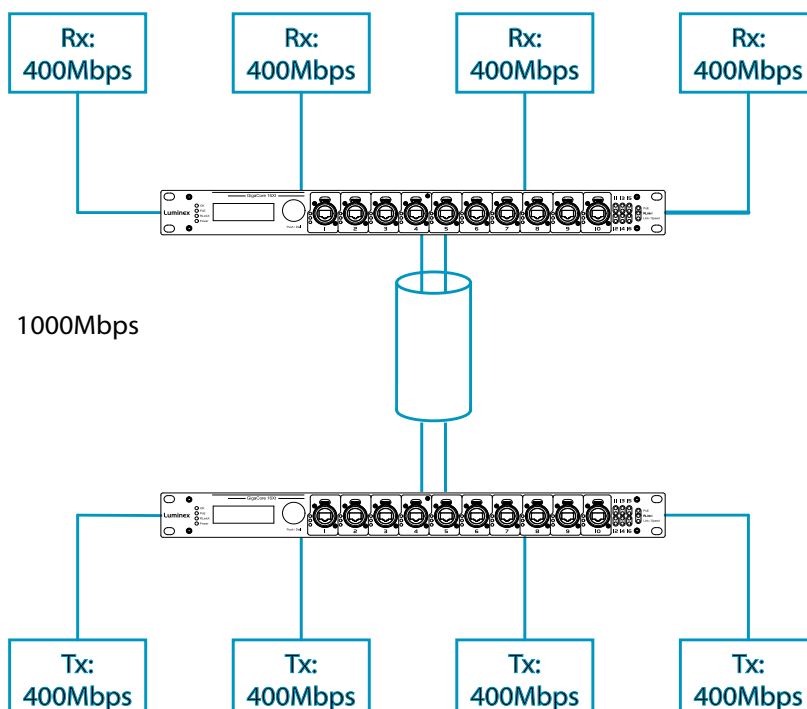

MultiLinkX enables you to gather several links together, and turn them into one virtual link. This provides you with more bandwidth available between the switches, and thus more throughput. MultiLinkX can accept as many ports as you want into an aggregation, and up to 8 aggregations can be created on a switch.

Working with PtP

When working with PtP (Precision Time Protocol), you'll notice an inverted PTP icon to indicate the PTP enabled port in an aggregation. You must always link the lowest ports of the active aggregation to each other to avoid problems with PTP. Best is to never create a cross link between ports in a different order.



1+1 is not 2 !

By adding an additional link into the aggregation, we can easily think we'll have the addition of all bandwidth available per cable.

However, MultiLinkX relies on LACP (Link Aggregation Control Protocol). The algorithm used by the protocol requires several parameters of the Ethernet frame to decide to which port of the aggregation the frame will be forwarded to. The protocol uses the following parameters:

- Source Mac Address
- Source IP Address
- Source Port (TCP/UDP)
- Destination IP address
- Destination Port (TCP/UDP)
- The ports included in the aggregation

In some circumstances, it might happen that several data streams will be forwarded to the same port. To know where the data stream will be forwarded to, you can have a look at our aggregation planning web page.

Simply type the following link into the address bar of your favorite web browser:

http://IPOFMYSWITCH/aggregation_code.html

src mac	00:50:b6:65:32:25
sender ip (ipv4 src ip)	192.168.1.83
ip/udp src port	51247
destination ip(ipv4)	239.255.0.2
ip/udp dst port	5568
Aggregated ports	7,8,9
target_port	7

According to the parameters of your Ethernet frame, the page will show you which port will be in use. This allows you to predict, but also to solve some problems. In the unlikely event of an overloaded link in an aggregation, user can solve the problem simply by changing the appropriate IP address for the source for instance.



MultiLinkX technology is available on the ISL ports only !

It is also a good habit to allocate the specific number of link in an aggregation to fulfill your throughput requirement, plus one link. If one link fails, you'll still have the minimum number of necessary link to transfer all your data !

Front end display (16Xt and RFO only)

The front end display offers basic information and configuration of the GigaCore 16Xt, such as network settings, ports info and groups assignment. Please find below the flowchart of the menu:

- Press
- ⦿ Press & Hold
- ⦿ Press & Hold, turn left
- ⦿ Press & Hold, turn right
- <> left & right navigation

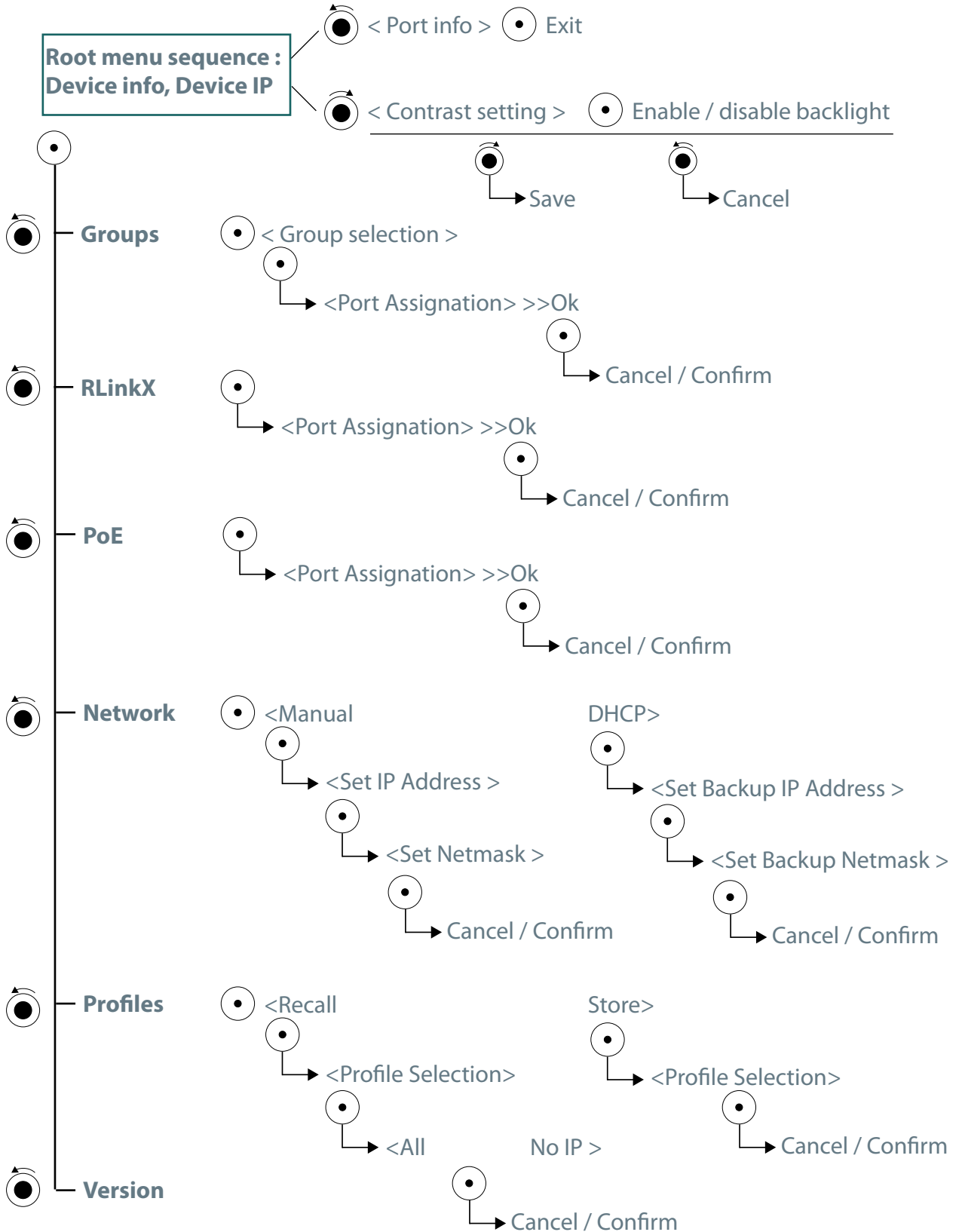

Connection to the web interface

Every GigaCore switch embeds a built-in web server, which excludes the need of a dedicated application to configure the unit. Browsers such as Chrome, Internet Explorer (IE 9 minimum), Firefox or Safari can be used to reach the web server.

Every unit comes with a default IP address, visible at the rear of the unit. Set your computer with an IP address within the same subnet (do not use the same IP address!)

- Example 1: Switch IP address: 192.168.1.1, Netmask: 255.255.255.0
Computer IP address: 192.168.1.2, Netmask 255.255.255.0
- Example 2: Switch IP address: 192.168.2.112, Netmask: 255.255.0.0
Computer IP address: 192.168.2.113, Netmask 255.255.0.0

Connect your computer to the switch with a Cat5E network cable at least, and launch your favorite web browser. Type the IP address of the switch in the address field, and press enter. You'll be prompted to enter a login:

Use **admin** in the login field, and leave the password field blank. You reach the status page of the GigaCore switch.

Status Page



The status page is split into several panes that will be described below:

Switch image :

The top image gives you a quick overview of the switch port status (front and rear). Active ports are filled with the following colours:

- Orange: 100Mbps link
- Green: 1000Mbps (1Gbps) link

RPSU connectors:

On the right hand side of the switch's image, two squares indicate the status of the RPSU connectors (PSU and PoE). Three different status colors are available:

- NO RPSU CONNECTED
- RPSU CONNECTED
- POWER ERROR

Wink:

The feature allows you to easily identify a GigaCore switch in a stack of devices. Click on the Luminex Logo on the switch image, all four status LEDs on the left hand side of the switch will start blinking three times.

Main menu :

On the left hand side, you can find the main menu. Click on any tab to reach the corresponding menu.

Port status :

This table gives you a quick overview of the switch's ports settings. Parameters such as port speed and legend can be modified in the following menu: Global > Port Settings (see "Port settings" on page 27)

IP Settings :

Find here all the network settings of the switch. These parameters can be modified in the following menu: Global > Device Settings (see "Device settings" on page 26)

System Info :

Find here all the device's info such as serial number, device name, system identifier, MAC address, system description, and if a configuration profile is currently in use. This information can be modified in the following menu:

Global > Device Settings (see "Device settings" on page 26)

Global Page

The global page contains four sub menus that are described below:



Device settings

This menu allows you to change IP and ID settings of the unit, and also the brightness of the front panel's LEDs.

IP settings: Assign here the IP address of your switch. This IP address will be used to reach the switch's web interface. If your network is equipped with a DHCP server, you can enable the DHCP client of the switch, for it to receive automatically an IP address from the DHCP server.

However, mind that if DHCP is enable, you can still assign an IP address to the switch. This IP address will be used if there is no DHCP server available at boot up.

Enter your default gateway IP address if your switch needs to be reached from a routed network.

ID settings: Set here the name of your switch, and add a description to easily identify your switch in your network.



Port settings

This menu allows you to change the port's speed, and add a legend to each port. Port speed drop down menu offers the following speed :

- Disabled : Disable the port. Port will appear grayed out on the top switch image
- Auto : The port detects automatically the speed of the connected device (default)
- 10Mbps HDX : 10Mbps Half Duplex
- 10Mbps FDx : 10Mbps Full Duplex
- 100Mbps HDX : 100Mbps Half Duplex
- 100Mbps FDx : 100Mbps Full Duplex
- 1Gbps FDx : 1000Mbps Full Duplex



Utilities

This page brings you the tool to reset your unit in different ways, and to set some default security parameters.

Reset

This menu allows the user to bring the switch into different levels of reset.

Preserve IP settings

Tick the upper check box if you wish to bring the unit back to the default settings, and keep the actual IP parameters set on the switch.

If you leave this checkbox unticked, the unit's IP address will be set back as the one printed at the back of the unit.

Reset the unit with this box unticked is equal to a Reset through the reset button (see "Reset" on page 40).

Preserve all user profiles

Tick the lower check box if you wish to bring the unit back to the default settings, and keep the profiles stored in the profile manager.

Press the **Apply Reset** button once you've selected the appropriate options for your reset. Reset the units with the two unticked checkboxes will bring the unit back to its factory settings. This is equivalent from a Factory Reset with the reset button (see "Factory Reset" on page 41).

Reboot

Press the "Reboot Now" button to reboot the unit. All your parameters will be preserved

Security

User can set here a password to protect the web interface's access.

Default login of the web interface is **admin**, there is no default password. Click on **Change Password** to apply your new settings.

Default Profile

By clicking on the checkbox, the user can protect the profile stored in slot 1 from being deleted or overwritten.

When the user performs a **Reload Default** from the front panel's mode button (see "Reload Default" on page 41), the unit will be reloaded with profile 1. This makes a handy tool to easily recall your favorite profile.

Once the first profile is protected and set as default profile, a lock will appear on the profile's tab.

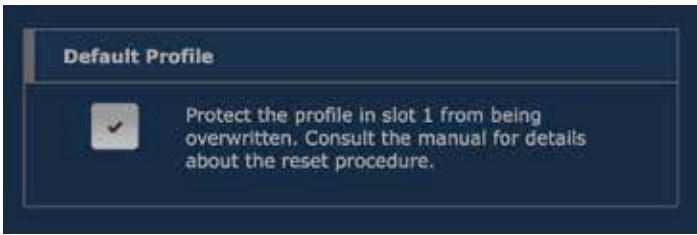

Locked Profile

Firmware

This menu allows you to upload a new firmware to the switch. Please visit the support section of our web site to get the latest firmware available for your GigaCore switch.

To upgrade the switch, simply click on the **Upload Firmware** button, and select the firmware on your computer. The upgrade procedure takes about 4 minutes to complete.



!! WARNING : DO NOT DISCONNECT POWER DURING FIRMWARE UPGRADE !!

Alternate image

If you're not satisfied with your recently uploaded firmware, you can always reload the previous firmware that was installed on the switch. Press the **Activate alternate firmware** button to reload the previous firmware. The downgrade process takes about 1 minute.

RLinkX



RLinkX Settings

RLinkX is meant to provide a trully plug and play redundant system (see "RLinkX" on page 30)

This menu allows you to enable / disable RLinkX on each port of the switch. An enabled RLinkX port is represented by a blue ring around the port.

To enable / disable a port, follow this procedure:

- 1- Click on the port(s) you wish to select. Selected ports will be highlighted.
- 2- Enable / Disable the port(s)
- 3- Click Apply to submit the changes

It is sometimes useful to disable RLinkX on some of the GigaCore switch's port. As an example, Ethersound devices do not comply with the RLinkX packet the switch sends out periodically, to maintain its redundant link.

The best practice is thus to disable RLinkX on the ports where end devices such as Ethersound or REAC need to be connected.

Once a minimum of two links are connected between two switches, blue LEDs on these ports will light up, indicating the redundancy is active and operational.

Advanced

MultiLinkX, our aggregation protocol, has been designed to work flawlessly with RLinkX, our redundancy protocol.

To provide users with a more advanced and efficient method to recover topology in case of link failure, Luminex has developed a new method for best link cost calculation in an aggregated network, based on the available bandwidth per link.

This calculation method is the default one when using MultiLinkX.

However, in the case you'd have to connect your aggregated links to an existing IT network, best is to select the usual path cost calculation, based on RSTP.

To select this method, simply click on the **Advanced** button, and select the RSTP method, and press apply.

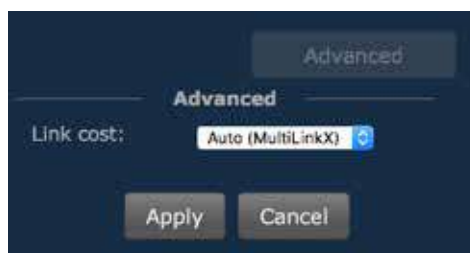

Indication

When a user connect a minimum of two aggregated links between two switches, it is easy to think these are redundant links. However, this is seen as a unique link between the switches. This is why the RLinkX LED won't lit up in this case. This is a normal behaviour.

Groups



Groups :

Groups is a technology which offers the user to easily segment its network into several subnets (see “Groups” on page 31). This menu allows you to assign ports into the 20 embedded groups of the switch. A group is a combination of port, and user can assign as many port as wanted into a group. The GigaCore range offers three types of groups :

- Group 0 (ISL) : This group is dedicated to the Inter Switch Links. This is the name given to the interconnection links between GigaCore switches in a network. The ISL links are meant to forward the groups based packets. In most case, the ISL links will be the redundant links (RLinkX). If you already have connected your redundant links, simply click on the advanced button, and press “Retrieve from RLinkX). The switch will automatically assign the redundant ports as ISL ports.
- Group 1 (Management). This group is dedicated to the management of the switch (web interface). You need to have at least one port of the switch assigned to that group, to be able to reach the web interface. In a star, ring or mesh network topology composed of GigaCore switches, you need to have at least one port of one switch set in this group, to be able to reach the web interface of all switches.
- Groupe 2 to 20 : These are the generic groups to be used for any purpose, such as sound, light, intercom, video....

To assign ports into a group, follow this procedure :

- 1- Select the group you wish to assign ports to. Use the colored index of the jog, and rotate the jog to change the group. If you wish to change the name of the group, simply click on the **Name** button
- 2- Select the ports you wish to assign to the group. Selected ports will be highlighted.
- 3- Click on the **Assign** button to assign ports to the group. If you're not satisfied with the selection of ports, and wish to restart your selection, simply click on the **Clear** button to reset the selection.
- 3- Click **Assign** to submit the changes. Ports colour will match the selected group index colour.





PLEASE KEEP IN MIND THE WEB INTERFACE OF A SWITCH CAN ONLY BE REACHED THROUGH A PORT ASSIGNED IN THE MANAGEMENT GROUP (FROM THE SWITCH YOU'RE CONNECTED TO, OR FROM ANOTHER SWITCH THROUGH AN ISL PORT). YOU NEED AT LEAST ONE PORT ASSIGNED IN THE MANAGEMENT GROUP IN YOUR ENTIRE NETWORK, TO REACH ALL YOUR GIGACORE'S WEB INTERFACES.

Advanced :



The advanced pane offers the user to access extended parameters such as :

VID : Luminex groups technology relies on the 802.1Q VLAN protocol. By default, Luminex groups have a default VLAN ID. If required, user can change the VID of the group. Mind that if you wish to change this VID, you'll need to change it on each switch using this group.

- **Snooping :** This button activates IGMP snooping. IGMP snooping is a smart way to manage multicast packets, and forward them to the registered ports. The main advantage of the IGMP snooping is to avoid ports to be flooded with unrequested packets.
- **Querier :** IGMP snooping requires at least one switch in a group to act as a querier. Querier register the multicast packets to the corresponding ports. If more than one querier is activated per group, the switch with the lowest IP address will be elected as querier. This election process is automated.

PTP V2 : The Luminex GigaCore series supports Precision Time Protocol Version 2

PtP is a protocol used to synchronize devices within a network, especially in audio over IP application.

With PtP V2, the GigaCore can be part of the clock domain, which is necessary for protocols such as AES67.

User can enable / disable PTP communications within the selected group, by validating the tick box, and by selecting the mode that better fits for the setup.

- E2E - End to End
- P2P - Peer to Peer

Domain : Please enter here a vale for your PtP domain

Press **Apply** to submit your changes. Mind you can have only one PtP setup per switch, so in one group only. In the status page, a stopwatch will be displayed for every port set in the group associated to a PtP domain.



MultiLinkX

MultiLinkX allows you to gather several links together, in order to increase the available bandwidth between switches. MultiLinkX is available for ISL ports only.

To enable MultiLinkX, simply select group zero (ISL) in the group page, and tick the box to enable MultiLinkX. Press Apply to submit the changes.

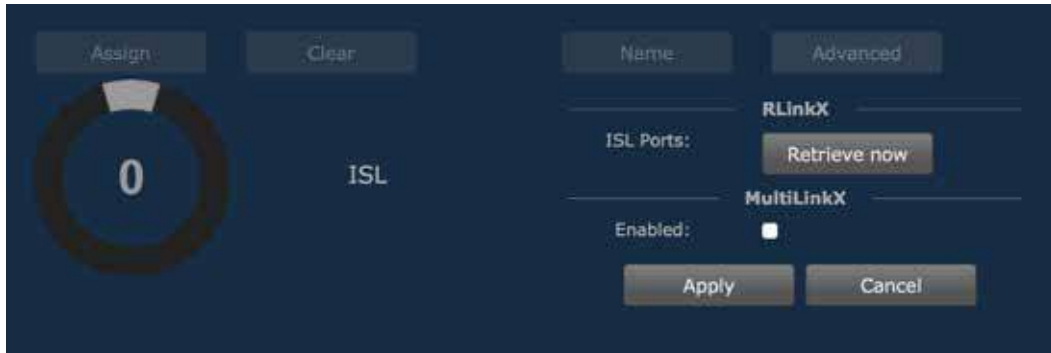

Once MultiLinkX is enabled on the ISL ports, a Magenta bar will appear below the selected ports.



Once MultiLinkX is active on the ISL ports, a White bar will appear below the selected ports.



PoE



PoE (Power over Ethernet) is a convenient way to transport both data and power over the same network cable, and thus powering a device with its data cable. Your GigaCore switch can then be a data connection box and power source for your end devices.

PoE supply will provide PoE enabled port as a default configuration (see illustration above).

A PoE enable port is displayed with a yellow latch above. When the switch is currently sourcing a PoE device through a port, the latch will turn orange, as the port's PoE LED on the front.

The PoE status page will offer the following info per port :

- The Powered Device Class (0,1,2...)
- The power consumption (Watts)
- The current consumption (mA)
- The priority (low, high, critical)
- The port status

On the right hand side of the page, a bargraph is here to display the current power consumption of the switch. The switch can deliver a total of 160W to share on the ten front ports, with a maximum of 30W per port (PoE+ compliant). Two arrows will indicate the following values :

- **Allocated power:** based on the classes of the connected PoE devices, the switch will allocate the necessary power to the PoE supply. This value is represented with a gray index.
- **Actual usage:** A green index will show the current power delivered by the PoE supply.

Settings

The setting page allows you to assign the following PoE parameters to the ten front ports :

- Enable / Disable PoE per port
- Assign a priority on the port

To change the PoE parameters of one or several ports, please apply the following procedure :



- 1- Select the port(s) you wish to modify
- 2- Enable or disable these port(s)
- 3- Select a priority for the port(s)
- 4-Apply your new parameters

The priority of a port is used when the switch reaches the limit of its maximum output power.

In the unlikely situation of PoE devices requiring too much power to the switch, the switch will first disable the port(s) with the lowest priority.

Profile Manager



The profile manager allows the user to easily save / recall / export / import a configuration. A profile will contain the following parameters :

- Device settings
- Port settings
- RLinkX settings
- Groups settings
- PoE settings.

In this way, user can create a comprehensive configuration of a switch, save it as a profile, and recall it later when needed. A maximum of ten profiles can be saved on a GigaCore switch.

The switch also offers to export / import a profile through a computer, providing user an easy way to exchange profile between switches.

From one switch, user will select a profile to export in a computer. Then, from the same computer, user will be able to load this profile into the empty slot of a secondary switch.

Exchanging profiles between switches can be a time saving process; User may start with one base configuration, and export it to the other switches for minor changes. These newly created profiles will then be saved locally.

■ Save a profile



If you wish to save the actual configuration of your switch, first select an empty slot amongst the 10 available slots. Press the **Save** button. A small window will pop-up, to enter the name of the profile.

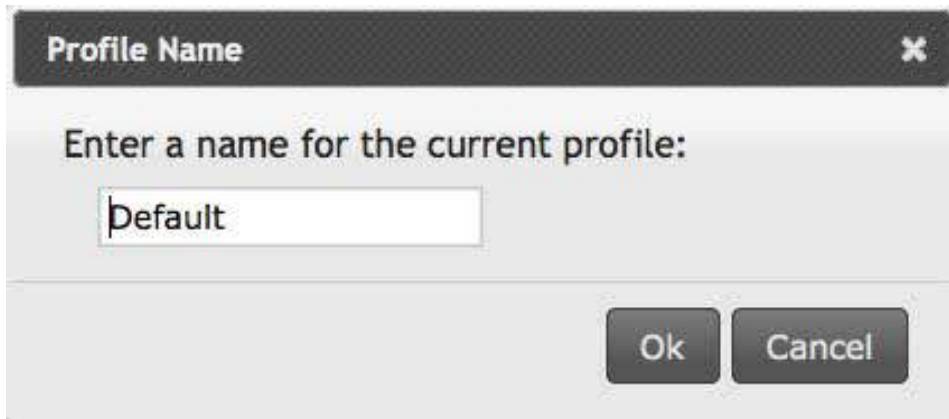

Click on **Ok**. Your profile is now saved in the switch



It is a good habit to always create a default configuration for your switch!

■ Recall a profile

To recall a profile, select it amongst the ten available profiles in upper tab. Here, you can preview the content of this profile.

Click on the **Recall** button. A window will pop-up to let you select either to reload the entire profile settings (Recall all), including the network settings, or just the switch configuration (No Network Settings). This very useful feature makes the exchange of profile between switches possible. You can thus avoid to get twice the same IP address on the network, by using the same profile.



Once you've selected the profile you wish to recall, the switch will reboot, and will reload the requested profile.

The recall process can take a minimum of 30 seconds, to a maximum of 2 minutes.

If you intend to reload a profile with a different IP address, you can try to reach the newly loaded IP address after about 50 seconds, manually from the switch's web interface.

Otherwise, the web interface of the switch will be automatically reloaded after a maximum of 2 minutes. Your computer's IP address needs to be set in the same subnet as the loaded profile's IP address.



PLEASE KEEP IN MIND THE WEB INTERFACE OF A SWITCH CAN ONLY BE REACHED THROUGH A PORT ASSIGNED IN THE MANAGEMENT GROUP (FROM THE SWITCH YOU'RE CONNECTED TO, OR FROM ANOTHER SWITCH THROUGH AN ISL PORT). PAY ATTENTION THE PROFILE YOU'RE GOING TO RECALL IS NOT CHANGING YOUR LINK TO THE WEB INTERFACE OF THE SWITCH YOU'RE WORKING WITH.

ALSO PAY ATTENTION TO THE IP ADDRESS THAT WILL BE RELOADED WITH THE PROFILE WILL NOT CONFLICT WITH ANOTHER IP ON THE NETWORK. SWITCH'S WEB INTERFACE MAY BECOME UNRESPONSIVE IN CASE OF IP CONFLICT.

■ Export a profile

To export a profile, select it amongst the ten available slots. Once selected, click on **Export** to download the profile to your computer. You'll be asked to select the download location of the profile on your computer.

■ Import a profile

To import a profile, select an empty slot in the profile manager tab. Once selected, click on **Import** to select the profile on your computer. Once the file is selected, validate to import the profile in the empty slot.

A message will confirm the successful import process.

■ Delete a profile

To delete a profile, simply select it amongst the ten available slots. Click on **Delete**. The profile will automatically be erased, and the preview window will display a blank space.



WHEN USER SAVE A PROFILE, THE OK LED WILL BLINK GREEN FOR ABOUT 5 SECONDS, TO INDICATE THE WRITING PROCESS TO THE FLASH MEMORY; PLEASE DO NOT SWITCH THE UNIT OFF WHILE THE OK LED IS BLINKING GREEN ! YOUR SWITCH CONFIGURATION MIGHT BE ERASED DURING THE NEXT BOOT UP.

■ Delete a profile

To delete a profile, simply select it amongst the ten available slots. Click on **Delete**. The profile will automatically be erased, and the preview window will display a blank space.

■ About the default profile

As detailed on page 28, the first slot of the profile manager can be locked. This will be indicated by a padlock on the profile itself. This profile can't be erased nor overwritten, unless you unlock it. To unlock the profile, untick the checkbox in the global>utilities page (see page 28).



■ Profile import policy

Please bear in mind the import policy between different models is available in the following conditions only :



	GigaCore 12	GigaCore 14R	GigaCore 16Xt	GigaCore 16 RFO
GigaCore 12	YES	YES	YES	YES
GigaCore 14R	NO	YES	YES	YES
GigaCore 16Xt	NO	NO	YES	YES
GigaCore 16 RFO	NO	NO	YES	YES



WHEN USER SAVE A PROFILE, THE OK LED WILL BLINK FOR ABOUT 5 SECONDS, TO INDICATE THE WRITING PROCESS TO THE FLASH MEMORY;
PLEASE DO NOT SWITCH THE UNIT OFF WHILE THE OK LED IS BLINKING GREEN ! YOUR SWITCH CONFIGURATION MIGHT BE ERASED DURING THE NEXT BOOT UP.

Reset the unit

In the case you need to reset the unit without the web interface, the GigaCore range of Ethernet switch offer different levels of reset, based on the ones you can find through the web interface.

- **Reset:** The unit is brought back to its default configuration, with the default IP address printed at the back of the unit. Profiles stored in the unit are preserved.
Default login: admin
Password: No password
- **Reload Default:** Profile stored in slot 1 is reloaded. The “Reload Default” is available only if the profile stored in slot 1 has been locked through the utility menu (see “Default Profile” on page 28). If this profile is set with a password, the user will need to enter it through the web interface to access the switch’s menus.
Default login: admin
Password: The one set for the profile (if there is one)
- **Factory Reset:** Unit is fully reset, profiles stored in the unit are deleted.
Default login: admin
Password: No password

THE FOLLOWING RESET PROCEDURES CAN BE ALSO BE ACHIEVED WITH THE FRONT END PANEL'S JOG (GIGACORE 16XT AND 16RFO ONLY)

Reset

- Condition 1: Unit is currently running
- Condition 2: There is no profile set as default profile (see “Default Profile” on page 28).

Hold the reset button at the rear of the unit for at least five seconds to see the four status’ LEDs blinking red. Releasing the reset button while the LEDs are blinking red will reset the unit.
Be aware that releasing the reset button during the first 5seconds before LEDS blink red will cancel operation.
Be aware that releasing the reset button during the 5seconds after LEDS blink red will cancel operation.



Reload Default

Condition 1: Unit is currently running

Condition 2: Profile stored in slot 1 needs to be locked through the utility menu (see "Default Profile" on page 17)

Hold the reset button at the rear of the unit for at least five seconds to see the four status' LED blinking **green**. If you release the button while the status' LED are blinking **green**, the unit will reload the profile stored in slot 1.

If you wait an additional 5 seconds, the status' LEDs will blink **red**, to provide you with a reset.

Releasing the reset button while the LEDs are blinking **red** will reset the unit.

Be aware that releasing the reset button during the first 5seconds before LEDS blink **green** will cancel operation.

Be aware that releasing the reset button during the 5seconds after LEDS blink **red** will cancel operation.



Factory Reset

Condition 1: Unit is off

Hold the reset button while connecting the unit to mains. After few seconds, the four status' LEDs will start blinking **red**.

Releasing the reset button while the LEDs are blinking red will factory reset the unit.

Be aware that releasing the reset button before LEDs blink red will cancel operation.

Be aware that releasing the reset button after LEDs blink red will cancel operation.

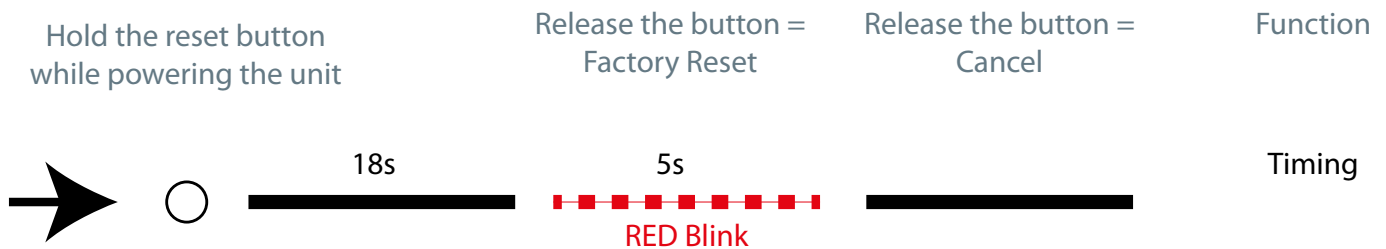

Specifications

Sheet 1/2

Connectivity	■ GigaCore I2	■ GigaCore I4R	■ GigaCore I6XT	■ GigaCore I6RFO
■ Network	<ul style="list-style-type: none"> 12 x 10/100/1000Mbps shielded Neutrik Ethercon connectors 10 on the front, 2 at the rear 	<ul style="list-style-type: none"> 12 x 10/100/1000Mbps shielded Neutrik Ethercon connectors 10 on the front, 2 at the rear 2 x SFP cages, compliant with 10/100/1000Mbps Mini GBIC transceiver 1 x serial RJ45 console port 	<ul style="list-style-type: none"> 12 x 10/100/1000Mbps shielded Neutrik Ethercon connectors 10 on the front, 2 at the rear 4 x SFP cages, compliant with 10/100/1000Mbps Mini GBIC transceiver 1 x serial RJ45 console port 1 x RJ45 expansion port 	<ul style="list-style-type: none"> 12 x 10/100/1000Mbps shielded Neutrik Ethercon connectors 10 on the front, 2 at the rear 4 x slots for D type compliant rugged fibre connector 4 on the front, 4 at the rear 1 x serial RJ45 console port
■ Power	<ul style="list-style-type: none"> 1 x IEC inlet with fuse holder 	<ul style="list-style-type: none"> 1 x IEC inlet with fuse holder 1 x redundant power input on Molex Micro-Fit 6 pins connector 1 x redundant PoE input on Molex Micro-Fit 6 pins connector 	<ul style="list-style-type: none"> 1 x IEC inlet with fuse holder 1 x redundant power input on Molex Micro-Fit 6 pins connector 1 x redundant PoE input on Molex Micro-Fit 6 pins connector 	<ul style="list-style-type: none"> 2 x Neutrik PowerCon True1 In/Out
Switch Features				
■ RLinkX	■ ✓	■ ✓	■ ✓	■ ✓
■ Groups	■ ✓	■ ✓	■ ✓	■ ✓
■ PoE Supply on the front ports	<ul style="list-style-type: none"> Optional (Requires LU 01 00051-GC12 PoE supply) Up to 160W spread on the ten front ports 	<ul style="list-style-type: none"> Optional (Requires LU 01 00051-GC14/16 PoE supply) Up to 160W spread on the ten front ports 	<ul style="list-style-type: none"> Optional (Requires LU 01 00051-GC14/16 PoE supply) Up to 160W spread on the ten front ports 	<ul style="list-style-type: none"> Optional (Requires LU 01 00051-GC16 RFO PoE supply) Up to 160W spread on the ten front ports
■ Fan	■ 1	■ 2	■ 2	■ 2
■ Ethernet Compliance	<ul style="list-style-type: none"> IEEE 802.3, IEEE 802.3u, IEEE 802.3x Flow Control, IEEE 802.3ab Gigabit Ethernet 	<ul style="list-style-type: none"> IEEE 802.3, IEEE 802.3u, IEEE 802.3x Flow Control, IEEE 802.3ab Gigabit Ethernet 	<ul style="list-style-type: none"> IEEE 802.3, IEEE 802.3u, IEEE 802.3x Flow Control, IEEE 802.3ab Gigabit Ethernet 	<ul style="list-style-type: none"> IEEE 802.3, IEEE 802.3u, IEEE 802.3x Flow Control, IEEE 802.3ab Gigabit Ethernet
■ Supported Protocols	<ul style="list-style-type: none"> Dante®, Ethersound®, REAC®, sACN, ArtNet, MANet2, Q-Lan and many more! IEEE 802.1p CoS (Class of Service) DiffServ (DSCP) PoE (802.3af) & PoE (802.3at) through optional module IEEE 1588 PTP V2 	<ul style="list-style-type: none"> Dante®, Ethersound®, REAC®, sACN, ArtNet, MANet2, Q-Lan and many more! IEEE 802.1p CoS (Class of Service) DiffServ (DSCP) PoE (802.3af) & PoE (802.3at) through optional module IEEE 1588 PTP V2 	<ul style="list-style-type: none"> Dante®, Ethersound®, REAC®, sACN, ArtNet, MANet2, Q-Lan and many more! IEEE 802.1p CoS (Class of Service) DiffServ (DSCP) PoE (802.3af) & PoE (802.3at) through optional module IEEE 1588 PTP V2 	<ul style="list-style-type: none"> Dante®, Ethersound®, REAC®, sACN, ArtNet, MANet2, Q-Lan and many more! IEEE 802.1p CoS (Class of Service) DiffServ (DSCP) PoE (802.3af) & PoE (802.3at) through optional module IEEE 1588 PTP V2
■ Sound protocol compliance	■ Yes. Low jitter	■ Yes. Low jitter	■ Yes. Low jitter	■ Yes. Low jitter
■ Ethernet Switch Type	■ Full non blocking wire-speed switching performance	■ Full non blocking wire-speed switching performance	■ Full non blocking wire-speed switching performance	■ Full non blocking wire-speed switching performance
■ Memory	■ 4Mb	■ 4Mb	■ 4Mb	■ 4Mb
■ MAC Address Table	■ 8192 Entries	■ 8192 Entries	■ 8192 Entries	■ 8192 Entries
■ Address Learning / Aging	■ Self learning, Auto aging	■ Self learning, Auto aging	■ Self learning, Auto aging	■ Self learning, Auto aging
■ Switching Throughput	■ 32Gbps	■ 32Gbps	■ 32Gbps	■ 32Gbps
■ IGMP support	■ Yes (V1/V2/V3)	■ Yes (V1/V2/V3)	■ Yes (V1/V2/V3)	■ Yes (V1/V2/V3)
■ IGMP Snooping	■ Yes, enabled by default	■ Yes, enabled by default	■ Yes, enabled by default	■ Yes, enabled by default
Port Features				
■ Port Sensing	■ Auto negotiation	■ Auto negotiation	■ Auto negotiation	■ Auto negotiation
■ Auto Crossover	■ MDI / MDIX (allow to use straight or cross wired cable)	■ MDI / MDIX (allow to use straight or cross wired cable)	■ MDI / MDIX (allow to use straight or cross wired cable)	■ MDI / MDIX (allow to use straight or cross wired cable)
■ Auto Sensing	■ Full or Half Duplex (Gigabit is Full Duplex)	■ Full or Half Duplex (Gigabit is Full Duplex)	■ Full or Half Duplex (Gigabit is Full Duplex)	■ Full or Half Duplex (Gigabit is Full Duplex)
Status Report				
■ Front End Display	■ ✗	■ ✗	■ ✓	■ ✓
■ Ethernet Port Connection	■ PoE (Orange LED), RlinkX (Blue LED), Link / Speed (Green/Orange LED)	■ PoE (Orange LED), RlinkX (Blue LED), Link / Speed (Green/Orange LED)	■ PoE (Orange LED), RlinkX (Blue LED), Link / Speed (Green/Orange LED)	■ PoE (Orange LED), RlinkX (Blue LED), Link / Speed (Green/Orange LED)
■ Ethernet Port Speed	■ 100/1000Mbps LED	■ 100/1000Mbps LED	■ 100/1000Mbps LED	■ 100/1000Mbps LED
■ Device	■ Status LED (Green / Red LED)	■ Status LED (Green / Red LED)	■ Status LED (Green / Red LED)	■ Status LED (Green / Red LED)
■ Power	■ Status LED (Green / Orange / Red LED)	■ Status LED (Green / Orange / Red LED)	■ Status LED (Green / Orange / Red LED)	■ Status LED (Green / Orange / Red LED)
■ PoE (Supply)	■ Status LED (Green / Orange / Red LED)	■ Status LED (Green / Orange / Red LED)	■ Status LED (Green / Orange / Red LED)	■ Status LED (Green / Orange / Red LED)
■ RLinkX	■ Status LED (Green)	■ Status LED (Green)	■ Status LED (Green)	■ Status LED (Green)

Sheet 2/2

Management	■ GigaCore I2	■ GigaCore I4R	■ GigaCore I6Xt	■ GigaCore I6RFO
■ Configuration	■ Through the built-in web server	■ Through the built-in web server	■ Through the built-in web server or with the front end display menu	■ Through the built-in web server or with the front end display menu
Power Input				
■ Power Input	■ 100-240VAC ■ 50-60Hz	■ 100-240VAC ■ 50-60Hz	■ 100-240VAC ■ 50-60Hz	■ 100-240VAC ■ 50-60Hz
■ Backup Power Input	■ ✗	■ 15VDC / 2A on Molex Micro-Fit ■ 6 pin connector	■ 15VDC / 2A on Molex Micro-Fit ■ 6 pin connector	■ 100 - 240VAC on Neutrik PowerCon True1 connector
■ Backup PoE Input	■ ✗	■ 48VDC / 2.1A on Molex Micro-Fit ■ 6 pin connector	■ 48VDC / 2.1A on Molex Micro-Fit ■ 6 pin connector	■ 100 - 240VAC on Neutrik PowerCon True1 connector
■ Power Consumption	■ Maximum 30W ■ Maximum 180W with PoE Supply Unit	■ Maximum 30W ■ Maximum 180W with PoE Supply Unit	■ Maximum 30W ■ Maximum 180W with PoE Supply Unit	■ Maximum 30W ■ Maximum 180W with PoE Supply Unit
■ Fuse	■ 3.15A 250V Slow Blow	■ 3.15A 250V Slow Blow	■ 3.15A 250V Slow Blow	■ ✗
Environmental				
■ Operating Temperature	■ 0 to +50 °C	■ 0 to +50 °C	■ 0 to +50 °C	■ 0 to +50 °C
■ Storage Temperature	■ -10 to +70 °C	■ -10 to +70 °C	■ -10 to +70 °C	■ -10 to +70 °C
■ Humidity (non condensing)	■ 5 to 95 % RH	■ 5 to 95 % RH	■ 5 to 95 % RH	■ 5 to 95 % RH
Physical				
■ Enclosure	■ Metal housing	■ Metal housing	■ Metal housing	■ Metal housing
■ Dimensions (W x D x H)	■ 482 x 204,3 x 44 mm ■ 19" x 8.04" x 1.73"	■ 482 x 204,3 x 44 mm ■ 19" x 8.04" x 1.73"	■ 482 x 204,3 x 44 mm ■ 19" x 8.04" x 1.73"	■ 482 x 294,15 x 88,45 mm ■ 19" x 11,58" x 3,48"
■ Packaging	■ 520 x 235 x 50 mm ■ 20,47" x 9,25" x 1,96"	■ 520 x 235 x 50 mm ■ 20,47" x 9,25" x 1,96"	■ 520 x 235 x 50 mm ■ 20,47" x 9,25" x 1,96"	■ 510 x 410 x 136 mm ■ 20,07" x 16,14" x 5,35"
■ Weight	■ 2.5Kg	■ 2.5Kg	■ 2.5Kg	■ 4.9Kg
Approvals				
■ CE	■ ✓	■ ✓	■ ✓	■ ✓
■ EN 55103-1	■ ✓	■ ✓	■ ✓	■ ✓
■ EN 55103-2	■ ✓	■ ✓	■ ✓	■ ✓
■ EN 60950-1	■ ✓	■ ✓	■ ✓	■ ✓
■ RoHS Compliance	■ ✓	■ ✓	■ ✓	■ ✓

Luminex LCE operates a policy of continuous development. Luminex LCE reserves the right to make changes and improvements to any of the products described in this document above without prior notice. Specifications are subject to change without notice.

Additional documentation

All additional documentation can be downloaded from our web pages.
please visit <http://www.luminex.be> for more information.

GigaCore Operating Manual

Document gigacore_full_manual_v240

Copyright © 2002-2017 .

All rights reserved.

No part of this documentation may be reproduced or transmitted in any form or by any means, electronic or mechanical, including photocopying and recording, without the prior written permission of Luminex.

The information in this documentation is supplied without warranty of any kind, either directly or indirectly, and is subject to change without prior written notice. Luminex, its employees or appointed representatives will not be held responsible for any damages to software, hardware, or data, howsoever arising as a direct or indirect result of the product(s) mentioned herein.

Issued by:

Publications Department,

Luminex LCE, Berkenlaan 8A, Hechtel Eksel, B-3940, Belgium.

Documentation last reviewed 28 March 2017 by Luminex LCE.

Printed in the EU.



Berkenlaan 8A
3940 Hechtel-Eksel
Belgium

T +32 11 812 189
info@luminex.be
support@luminex.be
www.luminex.be