

NANLITE

USER MANUAL

MixPanel 60/MixPanel 150

RGBWW LED PANEL LIGHT

MixPanel 60/MixPanel 150 RGBWW LED Panel Light

Product Show

Technical Data

Model: MixPanel 60

LED Power: 60W x 5

Power Input: 15V power adapter or

14.8V Sony V-mount battery(Not Included)

Color Temperature: 2700K - 7500K

CRI(Ra): 98

Model: MixPanel 150

LED Power: 150W x 5

Power Input: 24V power adapter or

26V Sony V-mount Battery(Not Included)

Color Temperature: 2700K - 7500K

CRI(Ra): 98

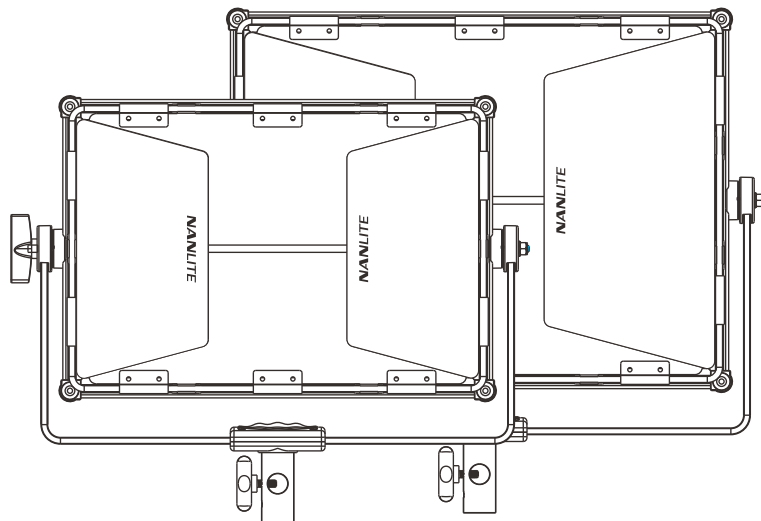

MixPanel 60

MixPanel 150

Variable Power Options

1. Connection between light fixture and power adapter.

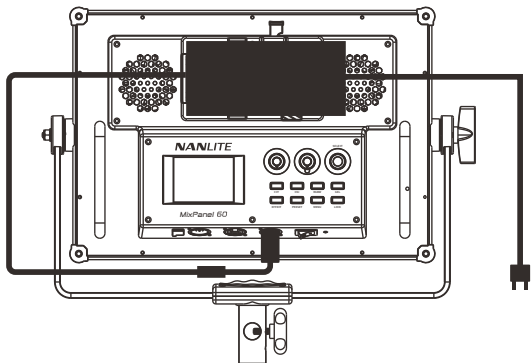

MixPanel 60

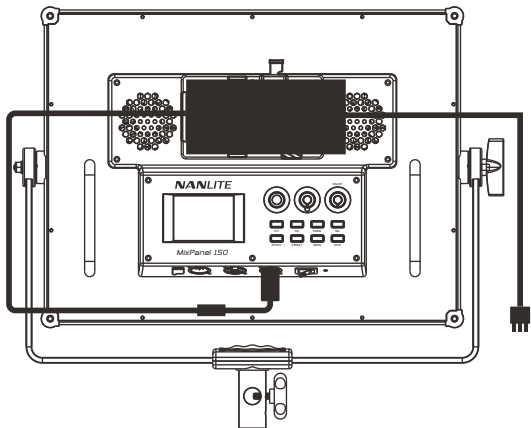

MixPanel 150

2. Connection between light fixture and battery.

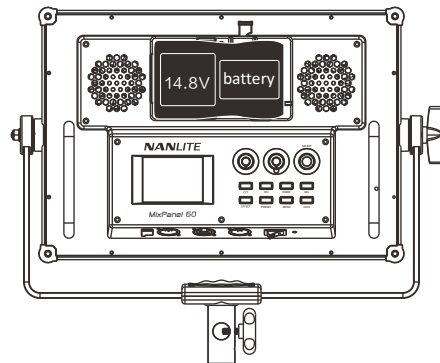

MixPanel 60

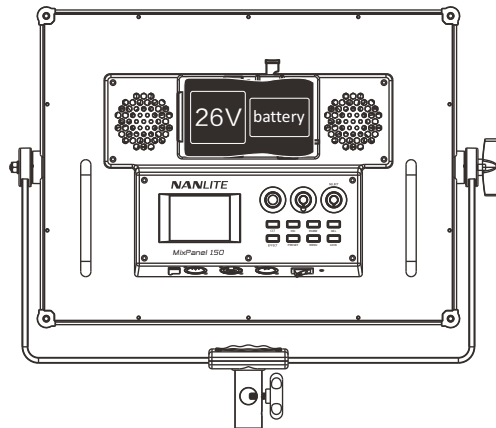

MixPanel 150

Barndoor Installation Instruction

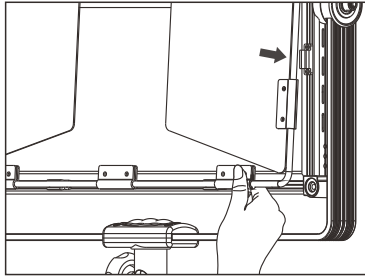

When installing the barndoor, make sure its mounts point line up with the slots on the light fixture. Now, snap in structure rods of barndoor into fastener slot on light fixture.

Note: when installing and removing the barndoor, please do not touch the diffuser on the front of light fixture to avoid surface scratches.

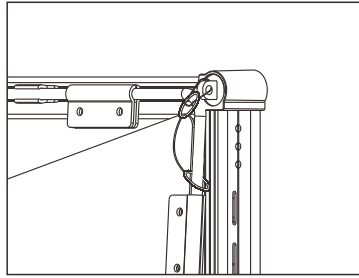

Fix the safety rope lock on the screw hole on the light fixture.

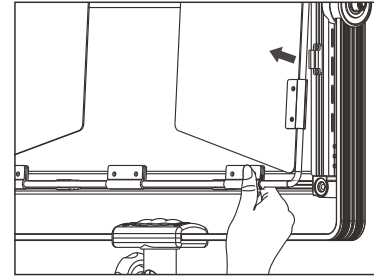

When removing the barndoor, remove the safety rope lock first, then pull the barndoor away from fixture.

Product Details

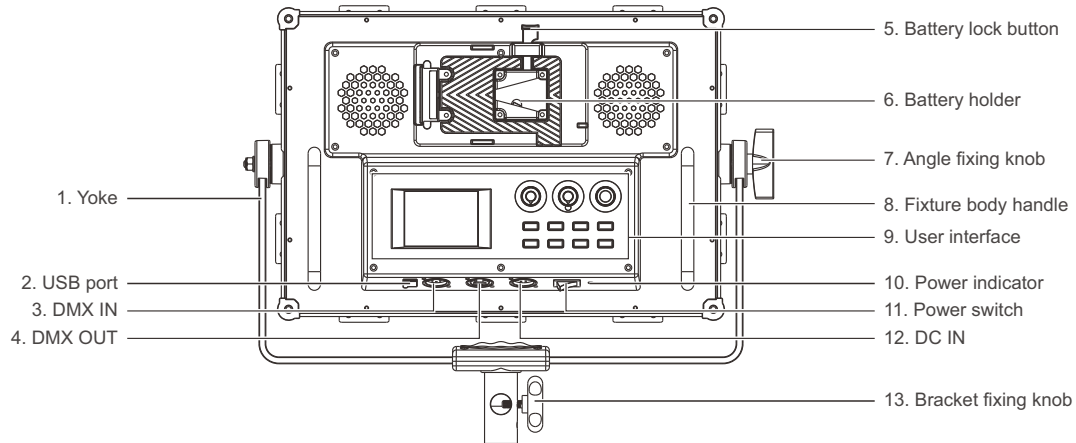

Product Details

1. Yoke: For connecting the fixture to the light stand and adjusting the tilt and pan of fixture.
2. USB port: For updating controller firmware.
3. DMX IN: DMX signal input interface.
4. DMX OUT: DMX signal output interface.
5. Battery lock button: For installing and removing the battery.
6. Battery holder: For installing V-Mount battery (Not Included).
7. Angle fixing knob: For adjusting and fixing the tilt angle of fixture.
8. Fixture body handle: To lift the fixture and adjust the direction of the light.
9. User interface: For displaying & controlling various function operations and data.
10. Power indicator: For checking the status of the power input. If the indicator is always on, it means normal power supply; if the indicator is flashing or off, it means abnormal power supply or no power input.
11. Power switch: For on/off the fixture.
12. DC IN: DC power input interface.
13. Bracket fixing knob: For connecting the fixture on a light stand.

Usage

1. Power Connection

- ①When connecting the power supply, please make sure the power, voltage and frequency is consistent with the provided power supply.
- ②When using a v-mount battery, please make sure to turn off the fixture and then plug in the battery.

Note: (1) Please do not use too much force when installing the battery properly.

(2) When removing the battery, make sure to press the battery unlock button to remove battery properly.

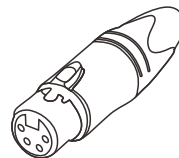
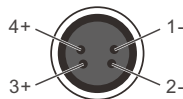

2. 2.4G Wireless Remote Control

MixPanel60/MixPanel150 is designed to work with a 2.4G remote controller or Nanlite WIFI-APP via WIFI transfer device to control light remotely.

NOTE: 2.4G remote controller or WiFi transfer device sold separately. (See separate instructions for remote controller or Wi-Fi transfer device)

3. DMX lighting console connection

NOTE: DMX cable should be bought additionally for connecting the MixPanel to a DMX lighting console.



· The connection between the light fixture and a DMX lighting console should use 5-pin XLR shielded cable and make sure its diameter is less than 0.3mm. XLR plug/ socket and the wire should be connected as pictured above.

· Pin 1, Pin 2, Pin 3 for connecting DMX signals, Pin 4, Pin 5 are unassigned.

NOTE: When connecting with socket, make sure the internal pins are not in contact with the inner case. The fixture can match the DMX 512(1990) control signal.

· Adapting 5-pin and 3-pin XLR plug/socket conversion is a compatible option. The optional DMX cable comes as a 5-pin XLR plug. If you use the 3-pin XLR plug, kindly follow below instruction.

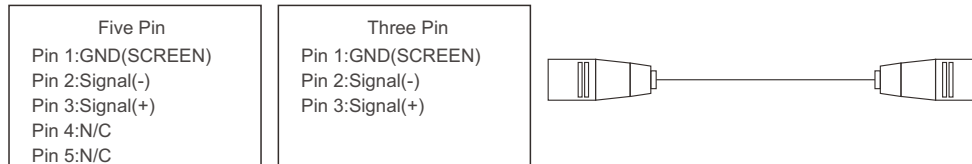

4. DMX-In Port

In DMX mode, make sure the last light is the only light with cable connected to DMX output. There is a resistance about 120 (OHM) between the second pin and third pin of this plug (as below photo). Make sure this plug is installed into the output of last fixture which can avoid noise and reflection phenomenon caused by DMX signal in the transmitting process.

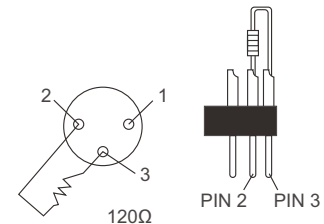

5. DMX Start Address Setting

When using a DMX console to control the fixture, each one must be set to its own DMX address, to receive the dimmer signal and response correctly. The fixture has total 2 DMX modes, accept DMX512 national standard signal.

Mode 1: Total 12 channels, set the first fixture's DMX start address to 001, 013 for the second one displays, 025 for the third one and so on.

Channel	Detail	DMX value	Description
1	DIM	000-255	Brightness Control
2	CCT	0-51	CCT
	HSI	52-102	HSI
	RGBW	103-153	RGBW
	GEL	154-204	GEL
	EFFECT	205-255	EFFECT
3			
CCT	CCT	000-255	CCT Adjustment 2700K-7500K
HSI	HUE	000-255	0-360
RGBW	RED Color Adjustment	000-255	
GEL	3200K	000-127	Filters color
	5600K	128-255	
EFFECT	HUE-LOOP	000-017	RGB cycle
	CCT-LOOP	018-034	CCT cycle
	FLASH	035-051	
	PULSE	052-068	
	STORM	069-085	
	POLICE CAR	086-102	
	TV	103-119	
	PAPARAZZI	120-136	
	CANDLE-FIRE	137-153	
	DISCO	154-170	

Channel	Detail	DMX value	Description
4			
CCT	G/M	000-255	(-50)-(+50)
HSI	SAT	000-255	0%-100%
RGBW	GREEN Color Adjustment	000-255	
GEL	FILTER-NUM	000-255	
EFFECT			
HUE-LOOP	HUE1	000-255	
CCT-LOOP	CCT1	000-255	
FLASH	CCT	0-127	
	HSI	128-255	
PULSE	CCT	0-127	
	HSI	128-255	
STORM	CCT	000-255	
POLICE CAR	B	0-63	
	RB	64-127	
	BW	128-191	
	RBW	192-255	
TV	CCT	000-225	
PAPARAZZI	CCT	000-225	
CANDLE-FIRE	ADD-RED	000-225	
DISCO	SAT	000-225	

Channel	Detail	DMX value	Description
5			
CCT	HARD	000-127	
	SOFT	128-255	
RGBW	BLUE Color Adjustment	000-255	
EFFECT			
HUE-LOOP	HUE2	000-255	
CCT-LOOP	CCT2	000-255	
FLASH	CCT	000-255	
	HSI	HUE	000-255
PULSE	CCT	000-255	
	HSI	HUE	000-255
STORM	RANDOM MODE	000-127	
	MANUAL MODE	128-255	
POLICE CAR	SINGLE	0-63	
	DOUBLE	64-127	
	TRIPLE	128-191	
	QUAD	192-255	
TV	G/M	000-255	
PAPARAZZI	SPEED	000-255	
CANDLE-FIRE	SAT	000-255	
DISCO	SPEED	000-255	
Channel	Detail	DMX value	Description
6			
RGBW	WHITE Color Adjustment	000-255	
EFFECT			
HUE-LOOP	SAT	000-255	
CCT-LOOP	SPEED	000-255	

Channel	Detail	DMX value	Description
6			
FLASH	G/M	000-255	
	SAT	000-255	
PULSE	G/M	000-255	
	SAT	000-255	
STORM	FLASH-TIMES-L	000-255	
TV	SPEED	000-255	
CANDLE-FIRE	SPEED	000-255	
	COLORS:3	0-31	
	COLORS:6	32-63	
	COLORS:9	64-95	
	COLORS:12	96-127	
	COLORS:15	128-159	
	COLORS:18	160-191	
	COLORS:21	192-223	
COLORS:24	224-255		
DISCO			
7			
EFFECT			
HUE-LOOP	SPEED	000-255	
CCT-LOOP	ONE-WAY	000-127	
	TWO-WAY	128-255	
FLASH	INTERVALS	000-255	
PULSE	PULSES/MIN	000-255	
STORM	FLASH-TIMES-H	000-255	
TV	DIMMING-RANGE-L	000-255	
CANDLE-FIRE	DIMMING-RANGE-L	000-255	

Channel	Detail	DMX value	Description
8			
EFFECT			
HUE-LOOP	ONE-WAY	000-127	
	TWO-WAY	128-255	
CCT-LOOP	ADD-ON:OFF	000-085	
	ADD-ON:FLASH	086-170	
	ADD-ON:PULSE	171-255	
FLASH	RAIO	000-255	
STORM	FLASH-SPEED	000-255	
CANDLE-FIRE	FLICKERS:ON	000-127	
	FLICKERS:OFF	128-255	
9			
EFFECT			
HUE-LOOP	ADD-ON:OFF	000-085	
	ADD-ON:FLASH	086-170	
	ADD-ON:PULSE	171-255	
CCT-LOOP	ADD-ON:FLASH ADD-ON:PULSE	INTERVALS	000-255
	ADD-ON:PULSE	PULSES/MIN	000-255
	ADD-ON:PULSE	PAUSE:ON	000-127
FLASH	PAUSE:ON	000-127	
	PAUSE:OFF	128-255	

Channel	Detail	DMX value	Description
9			
STORM	RANDOM	INTERVAL-RANG-L	000-255
	MANUAL	NO TRIGGER	000-127
		TRIGGER	128-255
10			
EFFECT			
HUE-LOOP	ADD-ON:FLASH	INTERVALS	000-255
	ADD-ON:PULSE	PULSES/MIN	000-255
CCT-LOOP	ADD-ON:FLASH	RATIO	000-255
	RANDOM	INTERVAL-RANGE-H	000-255
11			
EFFECT			
HUE-LOOP	ADD-ON:FLASH	RATIO	000-255
	ADD-ON:FLASH	PAUSE:ON	000-127
STORM	RANDOM	PAUSE:OFF	128-255
12			
LIGHTING		SILENT	000-085
		NORMAL	086-170
		BOOST	171-255

Mode 2 : Total 7 channels, set the first fixture's DMX start address to 001, 008 for the second one displays, 015 for the third one and so on.

Channel	Detail	DMX value	Description
1	R	0-255	
2	G	0-255	
3	B	0-255	
4	W	0-255	
5	Y	0-255	
6	HARD	0-127	
	SOFT	128-255	

Channel	Detail	DMX value	Description
7		SILENT	0-85
		NORMAL	86-170
		BOOST	171-255

Operating Instructions

1. Wiring (see sketch maps below)

- ①First, be sure that the power switch of the control unit is in the " off " position. Now it is safe to connect the adapter or battery and power unit on. If the power indicator is on that means the power supply is normal. The LCD screen will display all the relevant information for the fixture will appear, from the remaining battery power and address in lower right corner to the lighting mode in top left corner.
- ②CCT key: Press the CCT key to enter the operation interface of the CCT mode.
 - (1) Press the CCT key to switch between soft or hard light interface.

Soft light interface

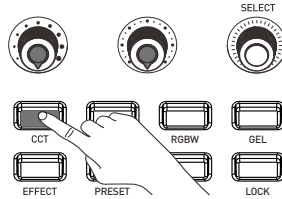
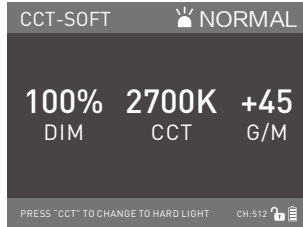

Hard light interface

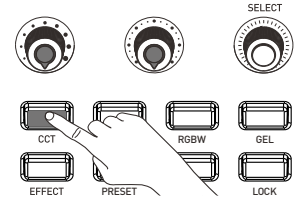
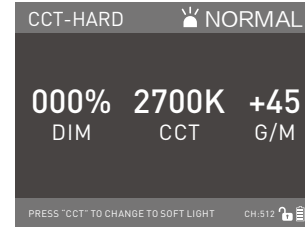

- (2) DIM setting: Rotate the dimmer knob, clockwise to increase the light's brightness while counterclockwise to reduce the light's brightness. Dim shows brightness percentage on the display. (As shown in figure 1)

Note: For any mode(except the RGBW mode), when pressing the " dimmer knob " , the fixture will be off and the LCD display shows the percentage of DIM is 000%. When pressing again, the fixture is returned to its previous status. Press the knob continuously to switch the fixture between off and on. (As shown in figure 2)

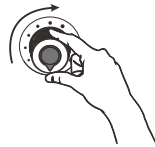
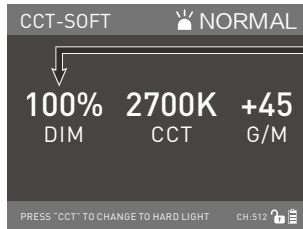

Figure 1

Clockwise rotation

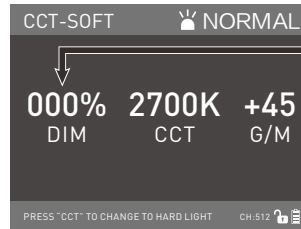

Figure 1

Counterclockwise



Figure 2

- (3) CCT setting: Rotate the "Function knob", clockwise to increase the color temperature while counterclockwise to reduce the color temperature. CCT shows the values of color temperature on the display, the color temperature range is from 2700K-7500K. (As shown in figure 3)
 Press the "Function knob" to adjust the color temperature in sequence, such as 2700K,3200K,4300K,5600K,6300K,7500K. If continuously to press, it will allow you to adjust circularly. (As shown in figure 4)

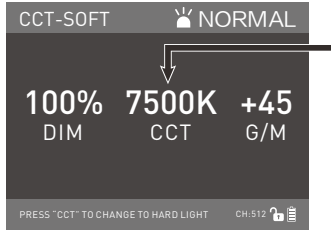
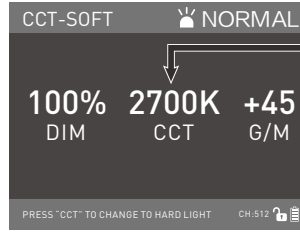

Figure 3



Counterclockwise

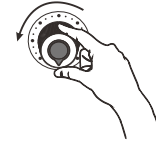

Figure 3



Figure 4

Clockwise rotation

- (4) G/M setting: Rotate the "SELECT knob", clockwise to increase the G/M value while counterclockwise to reduce the G/M value. G/M shows the G/M values on the display, the G/M range is from -50 to +50. Press the "SELECT knob" to reset its value to +00. (As shown in figure 5).

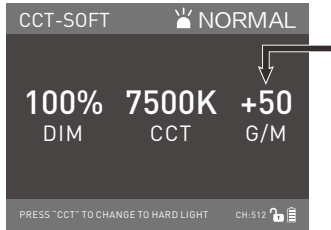
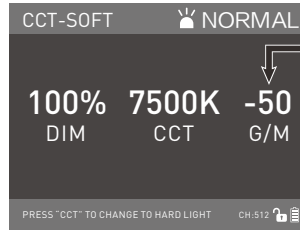

Figure 5



Counterclockwise

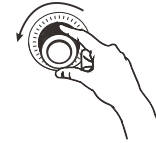
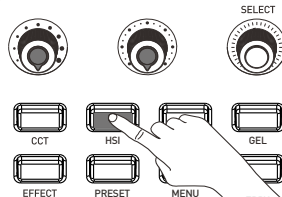

Figure 5



Clockwise rotation

- ③ HSI Key: Press the HSI key to enter the operation interface of the HSI mode.



(1) DIM setting: Rotate the " Dimmer knob" to adjust the brightness. (As shown in figure 6)

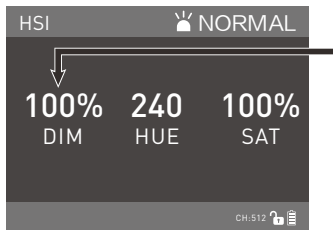

Figure 6

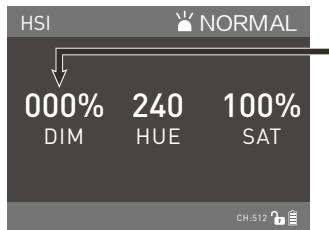

Figure 6

Clockwise rotation

Counterclockwise

(2) HUE setting: Rotate the " Function knob " to select HUE, the range of color adjusting range is 000-360, (As shown in figure 7) Press the " Function knob" to adjust the color in sequence, each time to press, the values will increase 60. When it gets to 360, it starts from 60 again. (HUE: 000: Red, HUE:120 :Green, HUE:240:Blue, HUE:360:Red). (As shown in figure 8)

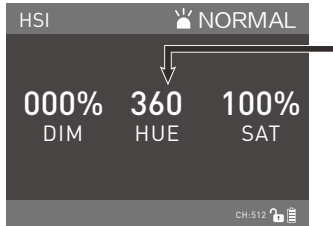

Figure 7

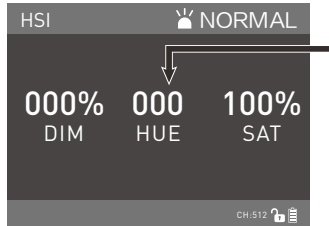

Figure 7



Figure 8

Clockwise rotation

Counterclockwise

(3) SAT setting: Rotate " SELECT knob" , clockwise to increase the color saturation while counterclockwise to reduce the color saturation. SAT shows the percentage of the color saturation on the display, the color saturation range is from 000%- 100%. Press the "SELECT knob", saturation wil cycle in 100%-075%-050%-025%-000%. (As shown in figure 9)

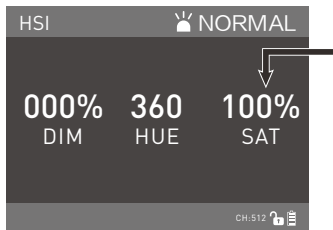

Figure 9

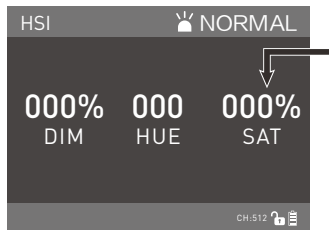
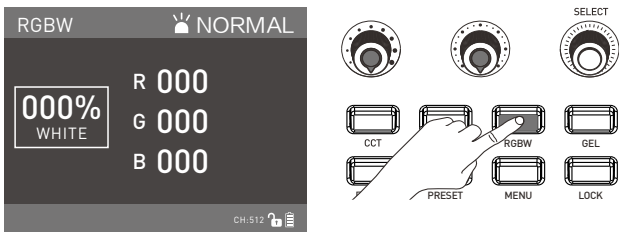

Figure 9

Clockwise rotation

Counterclockwise

④ RGBW Key: Press the RGBW key to enter the operation interface of the RGBW mode.



(1) Rotate the "SELECT knob" to select R, G, B or WHITE, then rotate the "Function knob" to adjust the ratio of R, G, B, WHITE values for mixing color. The range of adjusting R, G, B is from 000-255, and the range of adjusting WHITE is from 000%-100%.

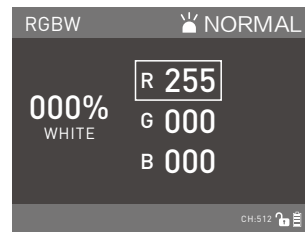
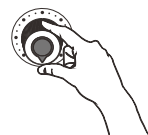
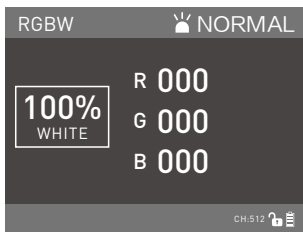
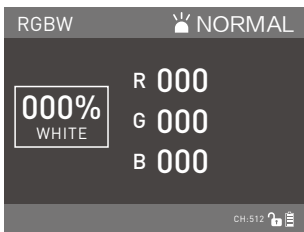

Rotate the "SELECT knob" to select R,G,B or WHITE

Rotate the "Function knob" to adjust the ration of R, G,B,WHITE

Rotate the "Function knob" to adjust the ration of R, G,B,WHITE

⑤ GEL Key: Press the GEL key to enter the operation interface of the GEL mode.

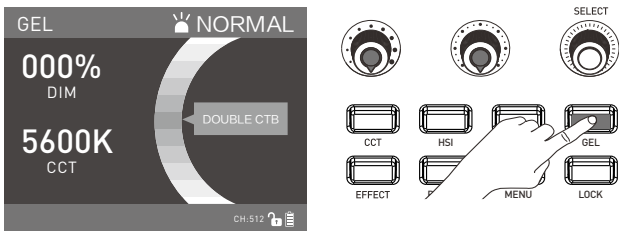

(1) DIM setting: Rotate the "Dimmer knob" to adjust the brightness.

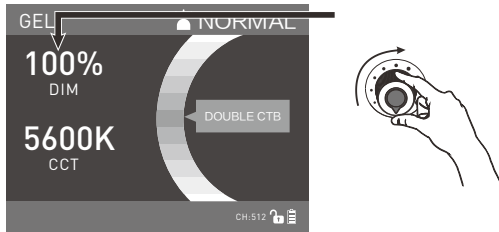

Clockwise rotation

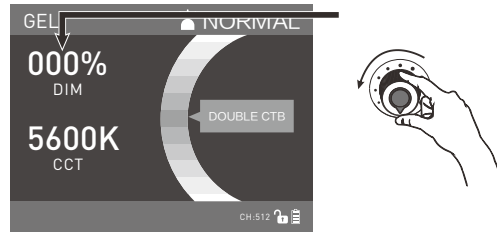

Counterclockwise

(2) CCT setting: Rotate or press the "Function knob" to select the range of color temperature from 3200K-5600K, CCT shows the current values of color temperature on the LCD display.

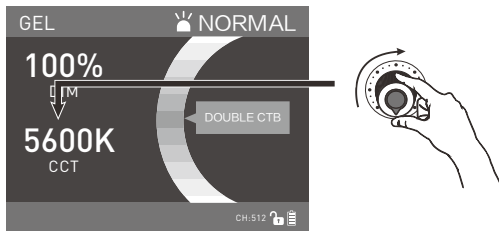

Clockwise rotation

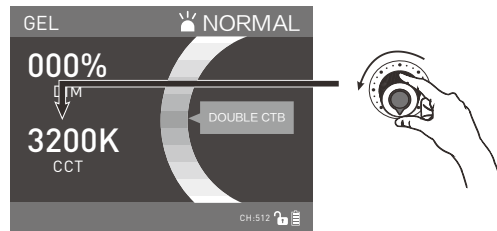

Counterclockwise

(3) GEL setting: Rotate the "SELECT knob" to select the filter you need. Total 43 kinds gels.



Rotate the "SELECT knob" to select the color filter

⑥ EFFECT key: Press the EFFECT key to enter the interface of special effect.

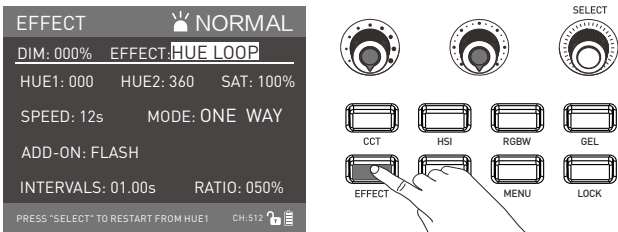

- MixPanel60/ MixPanel150 has total build-in 10 lighting modes, HUE LOOP/CCT LOOP/ FLASH/ PULSE/ STORM/ POLICE CAR/TV/ PAPARAZZI/ CANDLE/ FIRE/ DISCO.

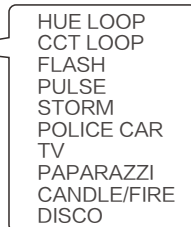
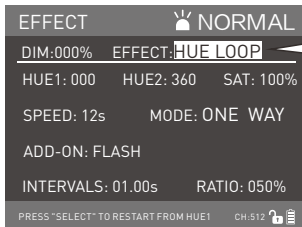
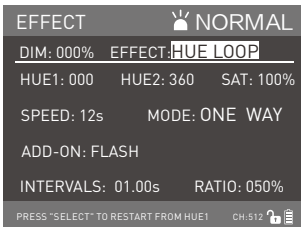

Rotate "SELECT knob" to EFFECT.

Rotate "Function knob" to select the special effect.

(1) HUE LOOP

- HUE LOOP has total two cycle modes: ONE WAY and TWO WAY.

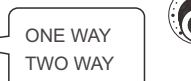
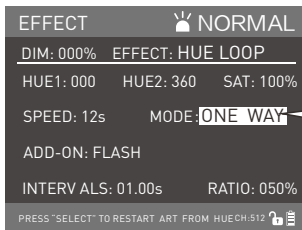
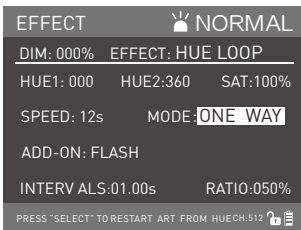

Rotate "SELECT knob" to MODE.

Rotate "Function knob" to select the mode.

· HUE LOOP has total three ADD-ON ways: OFF, FLASH, PULSE. When the add-on is in the "off" position, the lighting effect will cycle only.

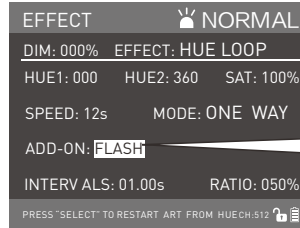
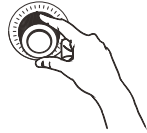
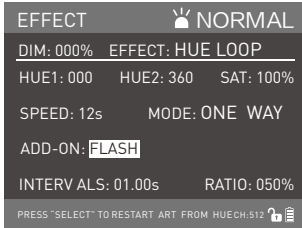

OFF
FLASH
PULSE

Rotate "SELECT knob" to ADD-ON.

Rotate "Function knob" to select the special effect.

· Rotate "Dimmer knob" to adjust the brightness, rotate "SELECT knob" to select HUE1, HUE2, SAT, SPEED, MODE, ADD-ON, then rotate "Function knob", to set up option and parameter according to demand.

FLASH(cycle and flash) add-on mode, INTERVALS is the flash interval period. Rotate "Function knob" to adjust flash interval period, adjustment range is 00.10S-10.00S.

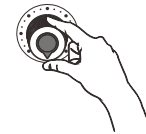
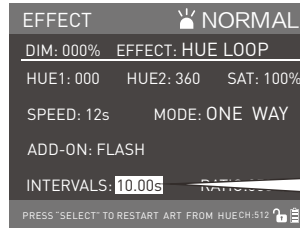
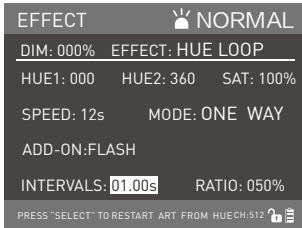

00.10s
:
10.00s

Rotate "SELECT knob" to INTERVALS.

Rotate "Function knob" to adjust flash interval period.

· ADD-ON: In FLASH mode, rotate the "function knob" to adjust the RATIO. The adjustment range is 000%-100%, the higher percentage, the longer the flash duration, 100% means the lamp is always on. 50% represents the time light is on and light off are the same. 000% represents the lamp always lighting-off in one period.

(As shown in right picture)

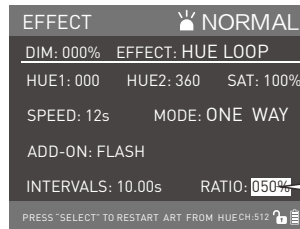

000%
:
100%

Rotate "Function knob" to adjust the ratio and the percentage of flash.

- ADD-ON: PULSE/MIN is to adjust the times in one pulse cycle, the adjustment range is 1-240, 50 means there has 50 pulses in one cycle period.

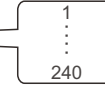
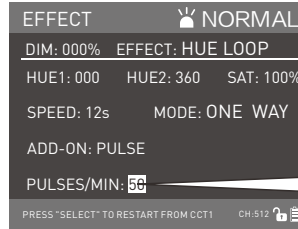
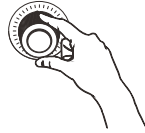
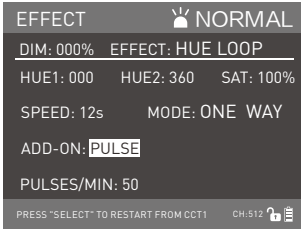

Rotate "SELECT knob" to PULSE/MIN.

Rotate "Function knob" to adjust the times of pulse.

(2) CCT LOOP

- CCT LOOP has total two modes: ONE WAY and TWO WAY.

CCT LOOP has total three ADD-ON ways: OFF(only cycle),FLASH(cycle and flash),PULSE(cycle and pulse).

- Rotate "Dimmer knob", to adjust the brightness, rotate "SELECT knob" to select CCT1, CCT2, SPEED MODE, ADD-ON, then rotate "Function knob", to set up options and parameter according to demands.

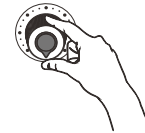
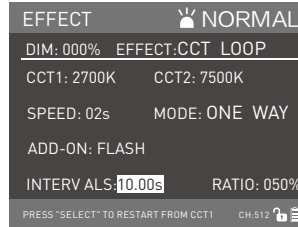
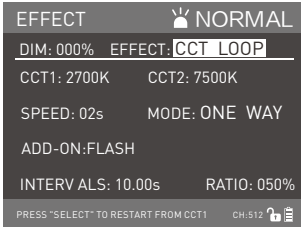

Rotate "SELECT knob" to adjust the selection

Rotate "Function knob" to set up options and parameter.

(3) FLASH

- FLASH has total 2 modes: CCT, HSI.

- Rotate "Dimmer knob" to adjust the brightness, rotate "SELECT knob" to MODE, then rotate "Function knob", to select the flash mode CCT or HSI according to demands.

- CCT mode, rotate "SELECT knob" to select CCT, G/M, INTERVALS, FLASH RATIO, PAUSE, then rotate "Function knob", to set up options and parameter according to demands.

PAUSE: to select ON or OFF according to demands.

- HSI mode, rotate "SELECT knob" to select HUE, SAT, INTERVALS, FLASH RATIO, PAUSE, then rotate "Function knob", to set up options and parameter according to demands.

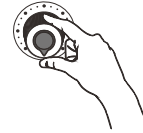
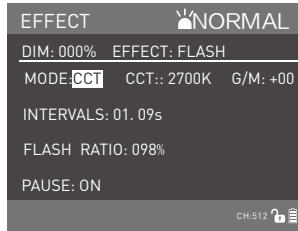
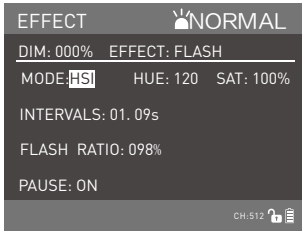

Rotate "SELECT knob" to adjust selection.

Rotate "Function knob" to set up options and parameter.

(4) PULSE

- PULSE has total two modes: CCT and HSI.
- Rotate "Dimmer knob" to adjust the brightness rotate "SELECT knob" to MODE, to select CCT and HSI.
- CCT mode, rotate "SELECT knob" to select CCT, G/M, PULSES/MIN, then rotate "Function knob", to set up options and parameter according to demands.
- HSI mode, rotate "SELECT knob" to select HUE, SAT, PULSES/MIN, then rotate "Function knob", to set up options and parameter according to demands.

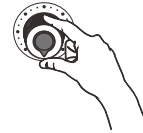
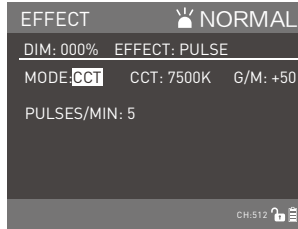
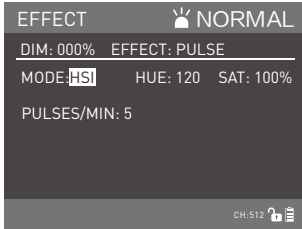

Rotate "SELECT knob" to adjust selection.

Rotate "Function knob" to set up options and parameter.

(5) STORM

- STORM offers two modes: RANDOM and MANUAL.
- Rotate "Dimmer knob", to adjust the brightness, rotate "SELECT knob" to select RANDOM or MANUAL, then rotate the "function knob" to select the RANDOM or MANUAL mode.
- RANDOM mode, rotate "SELECT knob" to select CCT, INTERVAL RANGE, FLASH TIMES, FLASH SPEED, PAUSE, then rotate "Function knob", to set up the options and parameter according to demands.
- MANUAL mode, rotate "SELECT knob" to select the CCT, FLASH TIMES, FLASH SPEED, then rotate "Function knob", to set up the options and parameter according to demands. After set up, press the "SELECT knob" to trigger the storm mode.

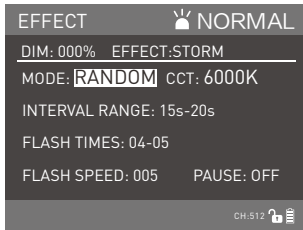

Rotate "SELECT knob" to adjust selection.

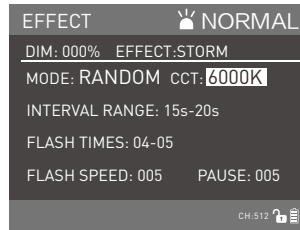

Rotate "Function knob" to set up the options and parameter.

(6) POLICE CAR

- Set up POLICE CAR mode, rotate "Dimmer knob", to adjust the brightness, rotate "SELECT knob" to COLOR, then rotate "Function knob", to select the color, rotate "SELECT knob" to MODE, then rotate "Function knob", to select the MODE for the police car lighting effect. (SINGLE/DOUBLE/TRIPLE/QUAD) .

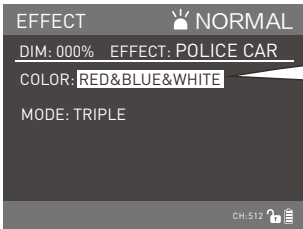

Rotate "Function knob" to select the lighting colors.

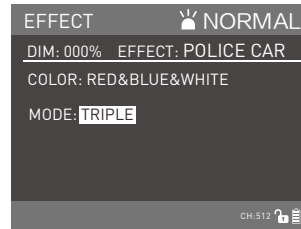

Rotate "Function knob", to select the MODE.

(7) TV

- Rotate "Dimmer knob", to adjust the brightness, rotate "SELECT knob" to select CCT, G/M, SPEED(TV flash speed, range is 001-100), DIMMING RANGE(brightness range, 000%-90%...000%-100%, 000%-100% same as Dimmer brightness percentage), then rotate "Function knob", to set up the options and parameter according to demands.

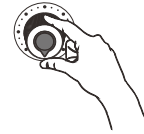
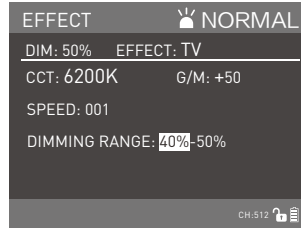
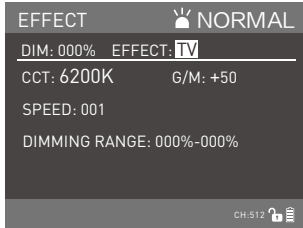

Rotate "SELECT knob" to adjust the selection.

Rotate "Function" to set up the options and parameter.

(8) PAPARAZZI

- Rotate "Dimmer knob", to adjust the brightness, rotate "SELECT knob" to select CCT, SPEED(camera shooting flash speed, range is 001-100), then rotate "Function knob", to set up the options and parameter according to demands.

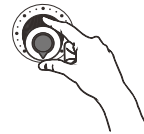
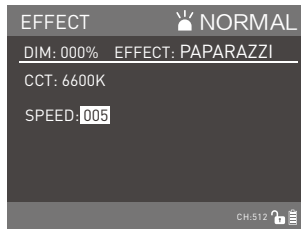
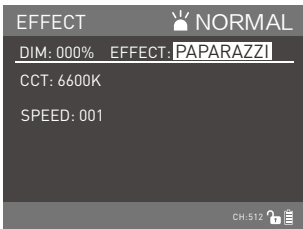

Rotate "SELECT knob" to adjust the selection.

Rotate "Function knob" to set up the options and parameter.

(9) CANDLE / FIRE

- Rotate "Dimmer knob", to adjust the brightness of candle, rotate "SELECT knob" to select ADD RED(adjust color, add red or reduce red, range is -50...+50), SAT, SPEED(the frequency of candle/fire flash, range is 001-100), DIMMING RANGE(Brightness range is from 000%-90%...000%-100%, and the 000%-100% is same as DIM brightness percentage.), FLICKERS, then rotate "Function knob", to set up options and parameter according to demands.
- FLICKERS could select ON or OFF based on the users' input.

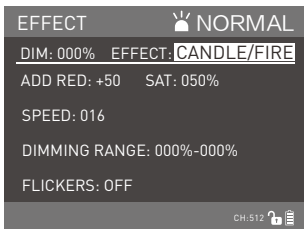

Rotate "SELECT knob" to adjust selection.

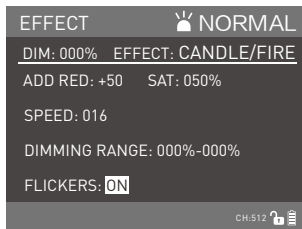

Rotate "Function knob" to set up options and parameter.

(10) DISCO

- Rotate "Dimmer knob", to adjust the brightness, rotate "SELECT knob" to select SAT, SPEED(The frequency of color changing, range is 001-100), COLORS(To select one of color change randomly from the total 03-24 colors), then rotate "Function knob" to set up options and parameter.

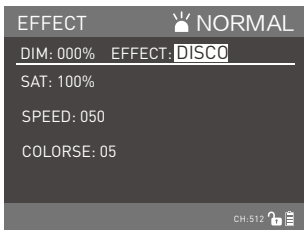

Rotate "SELECT knob" to adjust the selection.

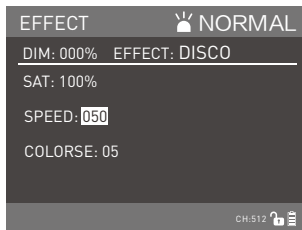

Rotate "Function knob" to adjust the options and parameter.

- Some special lighting effects may be updated for the upgraded controller firmware, please learn more details about our newest function description.

⑦ PRESET Key: When pressing the PRESET key to enter the MANAGE PRESET interface.

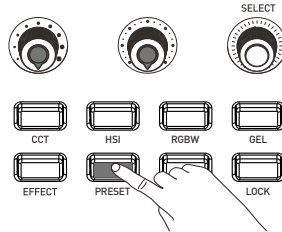

Press "SELECT knob" to switch to MANAGE PRESET or EXIT MANAGE.

· Long press the "PRESET" to save current lighting setting, enter the MANAGE PRESET interface to name and save the current lighting mode.

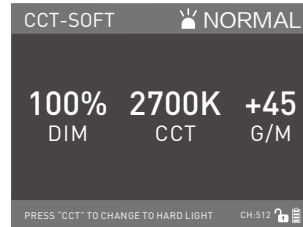
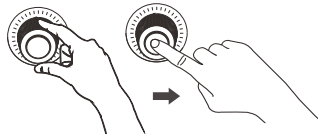
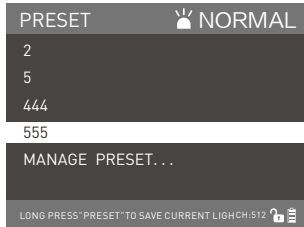
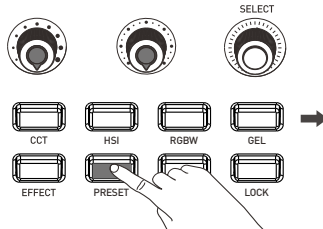
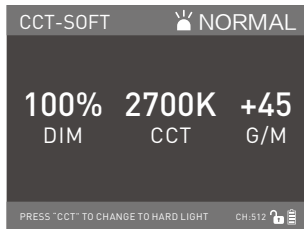

Select the saving lighting setting and press the "SELECT knob" to trigger the function.

The display shows the saved lighting setting.

- Press the "SELECT knob" to switch to EXIT MANAGE PRESET interface to change or delete the saved lighting settings. The current saved lighting setting can be renamed or deleting in the interface.

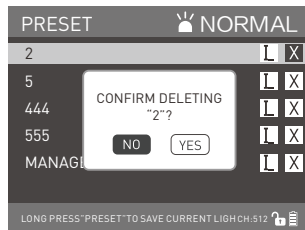
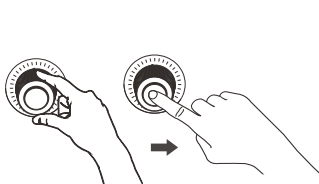
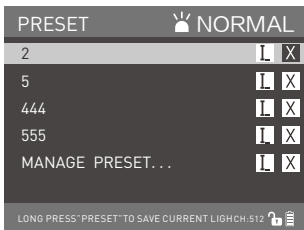

- ⑧MENU Key: Press the "MENU " to enter the main menu interface.

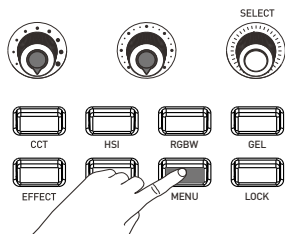
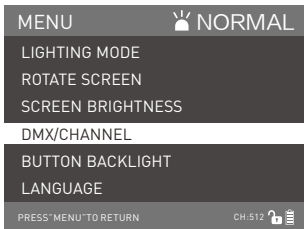

- (1) Rotate the "SELECT Knob" to select the setting item, press "SELECT Knob" to enter the corresponding secondary menu, rotate the "SELECT Knob" again to select the corresponding option, press the "SELECT Knob" to set or press the "MEUN" to return to the previous menu.

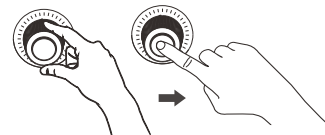
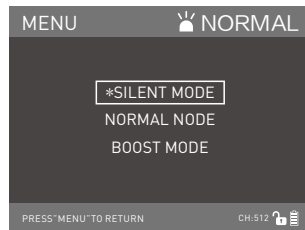
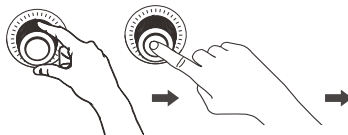
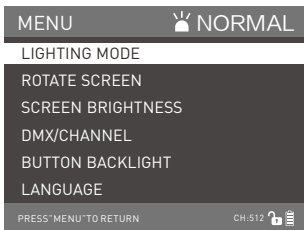

Rotate the "SELECT Knob" to the LIGHTING MODE, press "SELECT Knob" to enter the corresponding secondary menu.

Rotate "SELECT Knob" to select LIGHTING MODE, press "SELECT knob" to release the lighting mode.

MixPanel 60:

NORMAL MODE: Output power is 45W.

SILENT MODE: Output power is 30W.

BOOST MODE: Output power is 60W.

MixPanel 150:

NORMAL MODE: Output power is 112W.

SILENT MODE: Output power is 75W.

BOOST MODE: Output power is 150W.

(2) ROTATE SCREEN SETTING

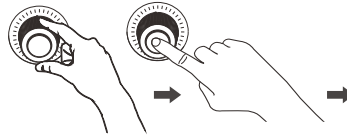
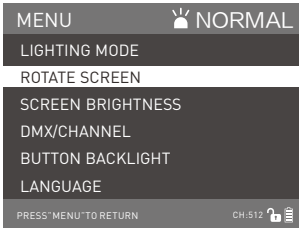

Rotate "SELECT Knob" to ROTATE SCREEN, press "SELECT Knob" to enter the corresponding secondary menu.

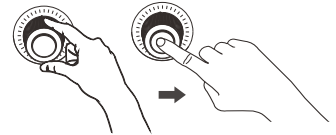
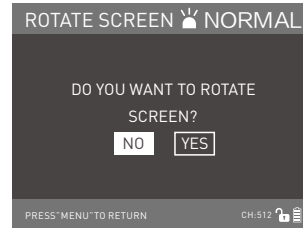

Rotate "SELECT Knob" to select the screen rotate mode, press "SELECT Knob" to confirm or cancel.

(3) SCREEN BRIGHTNESS SETTING

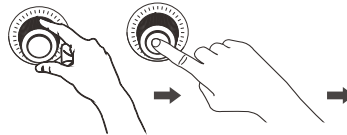
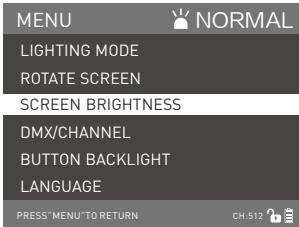

Rotate "SELECT Knob" to SCREEN BRIGHTNESS, press "SELECT Knob" to enter the corresponding secondary menu.

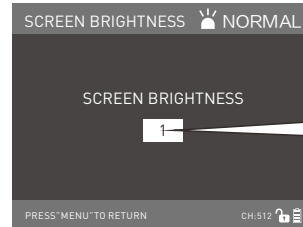

Rotate "SELECT Knob" to set the brightness of the screen.

(4) DMX MODE SETTING

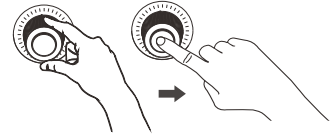
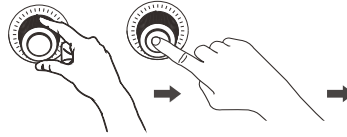
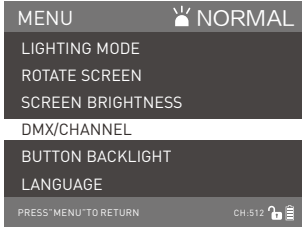

Rotate "SELECT Knob" to DMX/CHANNEL, press "SELECT Knob" to enter the corresponding secondary menu.

Rotate "SELECT Knob" to select the CHANNEL or DMX MODE, press "SELECT Knob" to enter the corresponding secondary menu.

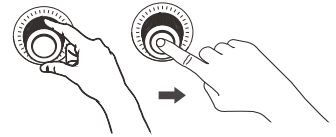
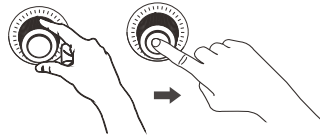
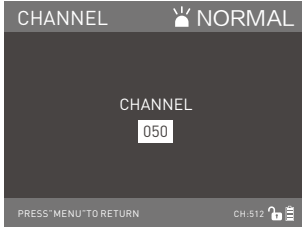

Rotate "SELECT Knob" to set the corresponding address code.

Rotate "SELECT Knob" to select MODE1 or MODE2.

(5) BUTTON BACKLIGHT SETTING

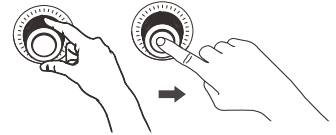
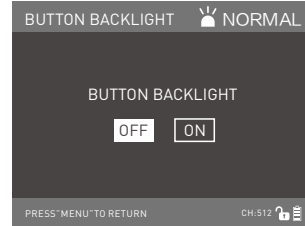
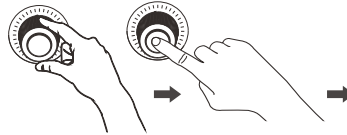
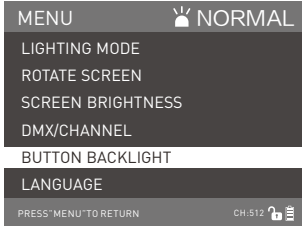

Rotate "SELECT Knob" to BUTTON BACKLIGHT, press "SELECT Knob" to enter the corresponding secondary menu.

Rotate "SELECT Knob" to select the language, press "SELECT Knob" to confirm or cancel.

(6) LANGUAGE SETTING

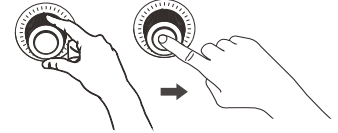
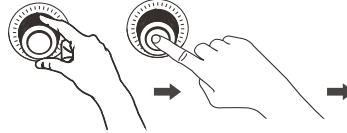
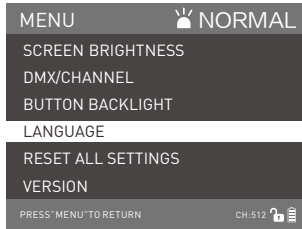

Rotate "SELECT Knob" to LANGUAGE, press "SELECT Knob" to enter the corresponding secondary menu.

Rotate "SELECT Knob" to select the language, press "SELECT Knob" to confirm or cancel.

(7) RETSET ALL SETTINGS

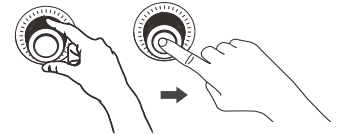
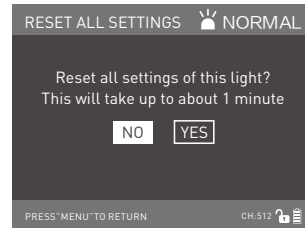
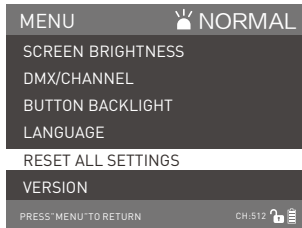

Rotate "SELECT Knob" to RESET ALL SETTINGS, press "SELECT Knob" to enter the corresponding secondary menu.

Rotate "SELECT Knob" to reset all setting of the light, press "SELECT Knob" to confirm or cancel.

(8) VERSION SETTING

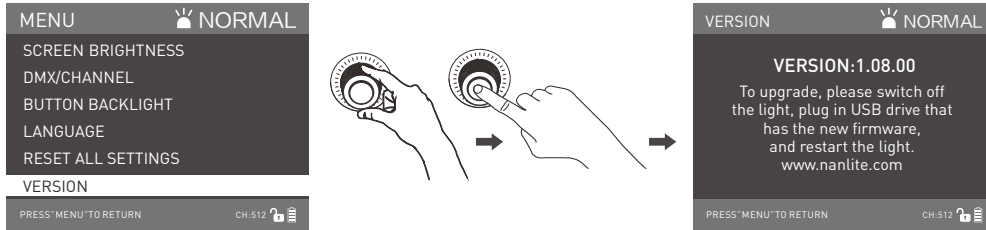

Rotate "SELECT Knob" to VERSION, press "SELECT Knob" to check the version of the fixture.

The users can check the version of the firmware for the fixture via the VERSION interface. Check whether the VERSION: 1.08.00 is the latest firmware compared with the official website, and you can download the latest firmware on the official website and upgrade firmware via USB port.

(9) When the fan stops working, press "SELECT Knob" to return to the previous operation interface, the lighting mode will switch to SILENT.

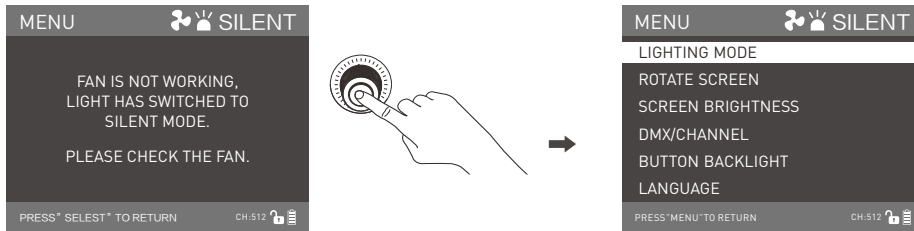

⑨LOCK Key: Long press "LOCK" for 2 seconds to lock the functions. At this moment, the operation button or knob cannot change the current status. Press the "LOCK" again for 2 seconds to release the locking status.

2. When stopping using the fixture, turn off the switch.

Safety Precautions

1. Please open the package to check if it is damaged due to transportation after receiving the light. In the case of damage caused by transportation, please do not use this light and contact the dealer or manufacturer as soon as possible.
2. Do not use a power cord with damaged insulation. Do not unplug hard or drag the power cord directly.
3. Make sure that the power supply voltage used matches the voltage specified by the light before installation.
4. When not using or cleaning the light, please turn it off.
5. Keep the light safely stored and away from children.





Notice



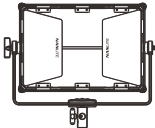

1. When the panel is on don't look direct at the emitter.
2. Don't place objects on the light emitter or allow liquid to flow inside the fixture or the emitter.
3. Don't place fixture near flammable substances like alcohol or gasoline.
4. When cleaning the fixture, please wipe off debris or dirt using a cloth and only dampen with water or a light cleanser.
5. The MixPanel 60 / 150 should be safely operated where it won't be at risk of getting wet or under extreme temperatures. Please make sure the ventilation fan is not blocked or obstructed.
6. Do not repair the MixPanel 60 / 150 by yourself. Professionals, please adhere to the user manual while troubleshooting.
7. For optimal cooling of the fixture, the vents should not be covered when using, or will damage the equipment. When using the lighting for a long time, the temperature of the lighting is high, please pay attention to anti-scalding.

General Fault Detection and Diagnosis

Fault Detection	Diagnosis
The light won't boot up properly!	<ol style="list-style-type: none">1. Please see if there are any loose connections between the adapter, power cord or power port on fixture.2. Please check if the adapter voltage is within specified parameters.3. If an external battery is used, please check if the battery is connected properly. Please check if battery voltage is within the specified voltage.
The fixture can operate by manual, but DMX control is not working.	<ol style="list-style-type: none">1. Please check whether the DMX original address setting of the fixture is correct or not.2. Check that the XLR signal cable is connected correctly or is damaged.
LCD display is on but can't operate the light.	Please check if the LCD screen display " LOCK ", long press the " LOCK " key for 2 seconds to release the LOCK.
The inside fan will not work.	<ol style="list-style-type: none">1. Please check if the fan is set to the off status manually.2. When the LCD screen display "  " in the right top corner, please check if the internal fan work normally.

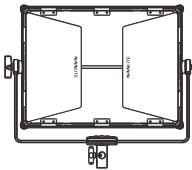
What's in the box? Please kindly check

MixPanel 60 x 1	Power Cable x 1	Power Adapter x 1
		
Carrying bag x 1	User Manual x 1	
		

MixPanel 150 x 1	Power Cable x 1	Power Adapter x 1
		
Carrying bag x 1	User Manual x 1	
		

Version:V5 2019-11-15

NANLITE

 +86-754-85751187

 +86-754-85300887

 service@nanlite.com

 Zhanglin,324,Dongli Chenghai Shantou Guangdong China

www.nanlite.com