

Panasonic®

Operating Instructions

4K Integrated Camera

Model No. **AW-UE80WP**

Model No. **AW-UE80KP**

Model No. **AW-UE80WE**

Model No. **AW-UE80KE**

Model No. **AW-UE80WED**

Model No. **AW-UE80KED**

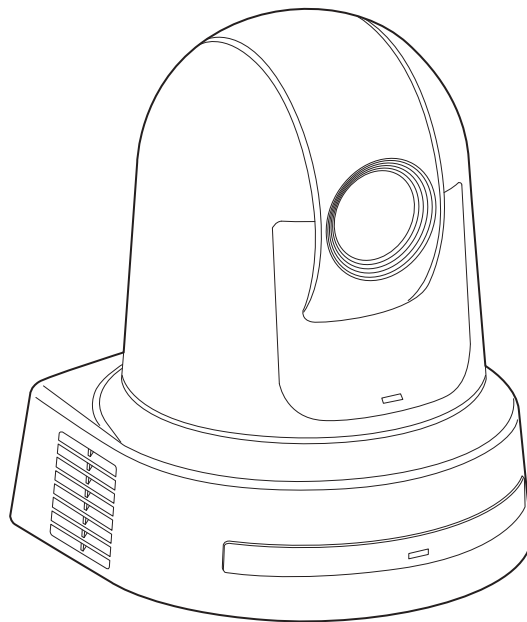

HEVC Advance™
Covered by patents at patentlist.accessadvance.com

HDMI™

Before operating this product, please read the instructions carefully and save this manual for future use. Please carefully read the "Read this first!" (pages 2 to 5) of this Manual before use.

Read this first! (For AW-UE80WP, AW-UE80KP)

WARNING:

- To reduce the risk of fire or electric shock, do not expose this equipment to rain or moisture.
- To reduce the risk of fire or electric shock, keep this equipment away from all liquids. Use and store only in locations which are not exposed to the risk of dripping or splashing liquids, and do not place any liquid containers on top of the equipment.

WARNING:

Always keep the main unit mounting screw, bracket mounting screws, drop-prevention wire mounting screw and pan stopper out of the reach of infants and small children.

WARNING:

Installation should only be performed by qualified installation personnel.
Improper installation may result in the entire apparatus falling down and causing injury.

CAUTION:

Do not remove panel covers by unscrewing.
To reduce the risk of electric shock, do not remove the covers.
No user serviceable parts inside.
Refer servicing to qualified service personnel.

CAUTION:

This apparatus can be operated at a voltage in the range of 100 – 240 V AC.
Voltages other than 120 V are not intended for U.S.A. and Canada.
Operation at a voltage other than 120 V AC may require the use of a different AC plug. Please contact either a local or foreign Panasonic authorized service center for assistance in selecting an alternate AC plug.

CAUTION:

The mains plug of the power supply cord shall remain readily operable.
The AC receptacle (mains socket outlet) shall be installed near the equipment and shall be easily accessible. To completely disconnect this equipment from the AC mains, disconnect the power cord plug from the AC receptacle.

CAUTION:

In order to maintain adequate ventilation, do not install or place this unit in a bookcase, built-in cabinet or any other confined space. To prevent risk of electric shock or fire hazard due to overheating, ensure that curtains and any other materials do not obstruct the ventilation.

CAUTION:

To reduce the risk of fire or electric shock and annoying interference, use the recommended accessories only.

CAUTION:

Check the installation at least once a year.
An improper installation could cause the unit to fall off resulting in personal injury.

CAUTION:

To reduce the risk of fire or electric shock caused by damage to the power supply cord, do not squeeze, bend, or pull the power supply cord when using the apparatus.

 indicates safety information.

FCC NOTICE (USA)

Supplier's Declaration of Conformity

Model Number: AW-UE80WP/AW-UE80KP

Trade Name: Panasonic

Responsible Party: Panasonic Corporation of North America

Two Riverfront Plaza, Newark, NJ 07102

Support contact: 1-800-524-1448

This device complies with part 15 of the FCC Rules.

Operation is subject to the following two conditions:

(1) This device may not cause harmful interference, and (2) this device must accept any interference received, including interference that may cause undesired operation.

FCC Note:

This equipment has been tested and found to comply with the limits for a class A digital device, pursuant to Part 15 of the FCC Rules.

These limits are designed to provide reasonable protection against harmful interference when the equipment is operated in a commercial environment. This equipment generates, uses, and can radiate radio frequency energy, and if not installed and used in accordance with the instruction manual, may cause harmful interference to radio communications. Operation of this equipment in a residential area is likely to cause harmful interference in which case the user will be required to correct the interference at his own expense.

Warning:

To assure continued FCC emission limit compliance, the user must use only shielded interface cables when connecting to external units. Also, any unauthorized changes or modifications to this equipment could void the user's authority to operate it.

 indicates safety information.

NOTIFICATION (Canada)

CAN ICES-3 (A)/NMB-3(A)

The symbols on this product (including the accessories) represent the following:

 AC
 DC

Read this first! (For AW-UE80WE, AW-UE80KE, AW-UE80WED, AW-UE80KED)

WARNING:

- To reduce the risk of fire or electric shock, do not expose this equipment to rain or moisture.
- To reduce the risk of fire or electric shock, keep this equipment away from all liquids. Use and store only in locations which are not exposed to the risk of dripping or splashing liquids, and do not place any liquid containers on top of the equipment.

WARNING:

Always keep the main unit mounting screw, bracket mounting screws, drop-prevention wire mounting screw and pan stopper out of the reach of infants and small children.

WARNING:

This equipment is compliant with Class A of CISPR 32. In a residential environment this equipment may cause radio interference.

WARNING:

Installation should only be performed by qualified installation personnel. Improper installation may result in the entire apparatus falling down and causing injury.

CAUTION:

Do not remove panel covers by unscrewing. To reduce the risk of electric shock, do not remove the covers. No user serviceable parts inside. Refer servicing to qualified service personnel.

CAUTION:

The mains plug of the power supply cord shall remain readily operable. The AC receptacle (mains socket outlet) shall be installed near the equipment and shall be easily accessible. To completely disconnect this equipment from the AC mains, disconnect the power cord plug from the AC receptacle.

CAUTION:

In order to maintain adequate ventilation, do not install or place this unit in a bookcase, built-in cabinet or any other confined space. To prevent risk of electric shock or fire hazard due to overheating, ensure that curtains and any other materials do not obstruct the ventilation.

CAUTION:

To reduce the risk of fire or electric shock and annoying interference, use the recommended accessories only.

CAUTION:

Check the installation at least once a year. An improper installation could cause the unit to fall off resulting in personal injury.

 indicates safety information.

Caution for AC Mains Lead

FOR YOUR SAFETY PLEASE READ THE FOLLOWING TEXT CAREFULLY.

This product is equipped with 2 types of AC mains cable. One is for continental Europe, etc. and the other one is only for U.K.

Appropriate mains cable must be used in each local area, since the other type of mains cable is not suitable.

FOR CONTINENTAL EUROPE, ETC.

Not to be used in the U.K.



FOR U.K. ONLY

If the plug supplied is not suitable for your socket outlet, it should be cut off and appropriate one fitted.

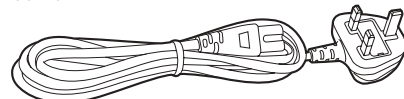



FOR U.K. ONLY

This appliance is supplied with a moulded three pin mains plug for your safety and convenience.

A 5 amp fuse is fitted in this plug.

Should the fuse need to be replaced please ensure that the replacement fuse has a rating of 5 amps and that it is approved by ASTA or BSI to BS1362.

Check for the ASTA mark  or the BSI mark  on the body of the fuse.

If the plug contains a removable fuse cover you must ensure that it is refitted when the fuse is replaced.

If you lose the fuse cover the plug must not be used until a replacement cover is obtained.

A replacement fuse cover can be purchased from your local Panasonic Dealer.

How to replace the fuse

1. Open the fuse compartment with a screwdriver.

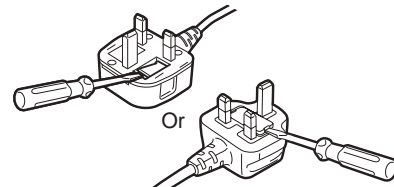

2. Replace the fuse.

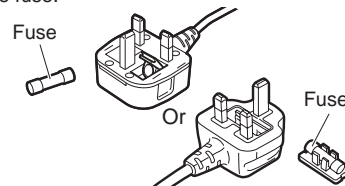

 indicates safety information.

The symbols on this product (including the accessories) represent the following:

 AC
 DC

Read this first! (For AW-UE80WE, AW-UE80KE)

EMC NOTICE FOR THE PURCHASER/USER OF THE APPARATUS

1. Pre-requisite conditions to achieving compliance with the above standards

<1> Peripheral equipment to be connected to the apparatus and special connecting cables

- The purchaser/user is urged to use only equipment which has been recommended by us as peripheral equipment to be connected to the apparatus.
- The purchaser/user is urged to use only the connecting cables described below.

<2> For the connecting cables, use shielded cables which suit the intended purpose of the apparatus.

- Video signal connecting cables
Use double shielded coaxial cables, which are designed for 75-ohm type high-frequency applications, for SDI (Serial Digital Interface). Coaxial cables, which are designed for 75-ohm type high-frequency applications, are recommended for analog video signals.
- Audio signal connecting cables
If your apparatus supports AES/EBU serial digital audio signals, use cables designed for AES/EBU.
Use shielded cables, which provide quality performance for high-frequency transmission applications, for analog audio signals.
- Other connecting cables (IEEE1394, USB)
Use double shielded cables, which provide quality performance for high-frequency applications, as connecting cables.
- When connecting to the DVI signal terminal, use a cable with a ferrite core.
- If your apparatus is supplied with ferrite core(s), they must be attached on cable(s) following instructions in this manual.

2. Performance level

The performance level of the apparatus is equivalent to or better than the performance level required by these standards. However, the apparatus may be adversely affected by interference if it is being used in an EMC environment, such as an area where strong electromagnetic fields are generated (by the presence of signal transmission towers, cellular phones, etc.). In order to minimize the adverse effects of the interference on the apparatus in cases like this, it is recommended that the following steps be taken with the apparatus being affected and with its operating environment:

1. Place the apparatus at a distance from the source of the interference.
2. Change the direction of the apparatus.
3. Change the connection method used for the apparatus.
4. Connect the apparatus to another power outlet where the power is not shared by any other appliances.

Turkey Only

AEEE Yönetmeliğine Uygundur.
AEEE Complies with Directive of Turkey.



Disposal of Old Equipment

Only for European Union and countries with recycling systems

This symbol on the products, packaging, and/or accompanying documents means that used electrical and electronic products must not be mixed with general household waste.

For proper treatment, recovery and recycling of old products, please take them to applicable collection points in accordance with your national legislation.

By disposing of them correctly, you will help to save valuable resources and prevent any potential negative effects on human health and the environment. For more information about collection and recycling, please contact your local municipality, dealer or supplier.

Penalties may be applicable for incorrect disposal of this waste, in accordance with national legislation.

Manufactured by: Panasonic Corporation, Osaka, Japan
Importer's name and address of pursuant to EU rules:
Panasonic Marketing Europe GmbH
Panasonic Testing Centre
Winsbergring 15, 22525 Hamburg, Germany

Інформація для покупця

Виробник:	Panasonic Corporation	Панасонік Корпорейшн
Адреса виробника:	Kadoma, Osaka, Japan	Кадома, Осака, Японія
Країна походження:	China	Китай

Імпортер:	ТОВ "ПАНАСОНІК УКРАЇНА ЛТД"
Адреса імпортера:	вул. Васильківська, буд. 30, м. Київ 03022, Україна

Примітки:

Термін служби виробу	7 років
----------------------	---------

Дата виготовлення може бути визначена за допомогою комбінації літер та цифр серійного номера, розташованого на продукті.

Приклад: X X XXXXXX

Рік: остання цифра року (7 – 2017, 8 – 2018,...0 – 2020)
Місяць: А – Січень, В – Лютий... L – Грудень

Read this first!

Note on grounding

- Ground the unit via the <SIGNAL GND> ground connector.

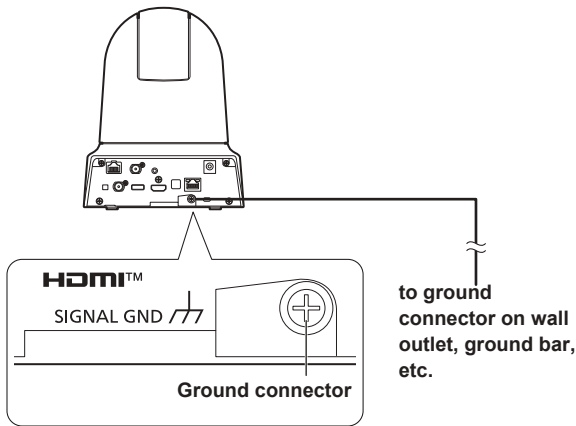

Trademarks and registered trademarks

- Microsoft®, Windows®, Windows® 10, Microsoft Edge, Internet Explorer®, ActiveX® and DirectX® are either registered trademarks or trademarks of Microsoft Corporation in the United States and other countries.
- Apple, Mac, macOS, iPadOS, iPhone, iPad, and Safari are registered trademarks of Apple Inc., in the United States and other countries.
- Android™ and Chrome™ browser are trademarks of Google LLC.
- Intel® and Intel® Core™ are trademarks or registered trademarks of Intel Corporation in the United States and other countries.
- Adobe® and Reader® are either registered trademarks or trademarks of Adobe Systems Incorporated in the United States and/or other countries.
- The terms HDMI and HDMI High-Definition Multimedia Interface, and the HDMI Logo are trademarks or registered trademarks of HDMI Licensing Administrator, Inc. in the United States and other countries.
- NDI is a registered trademark of NewTek, Inc. in the United States.
- Other names of companies and products contained in these Operating Instructions may be trademarks or registered trademarks of their respective owners.

About copyright and licence

It is expressly prohibited to distribute, copy, disassemble, reverse compile, modify, reverse engineer, or export in violation of export laws the software provided with the unit.

Abbreviations

The following abbreviations are used in this manual.

- Windows® Internet Explorer® 11 32/64-bit is abbreviated to "Internet Explorer".

For the purposes of this manual, the model numbers of the units are given as listed in the table below.

Model number of unit	Model number given in manual
AW-UE80WP, AW-UE80KP, AW-UE80WE, AW-UE80KE, AW-UE80WED, AW-UE80KED	AW-UE80
AW-RP150G	AW-RP150
AW-RP60G	AW-RP60
AV-HLC100P, AV-HLC100E	AV-HLC100
AV-UHS500P, AV-UHS500E	AV-UHS500

Illustrations and screen displays featured in the manual

- What is shown in the manual's illustrations and screen displays may differ from how it is actually appears.
- Functions which can be used by Windows Internet Explorer 11 only are indicated using the [Windows I.E.11](#) mark.
- The screenshots are used in accordance with the guidelines of Microsoft Corporation.

Contents

Read this first! (For AW-UE80WP, AW-UE80KP)	2
Read this first! (For AW-UE80WE, AW-UE80KE, AW-UE80WED, AW-UE80KED)	4
Read this first! (For AW-UE80WE, AW-UE80KE)	5
Read this first!	6
Note on grounding	6
Before use	8
Overview	8
Computer requirements	8
Disclaimer of warranty	9
Network security	9
Features	10
Accessories	11
Optional accessories	11
Operating precautions	12
Wireless remote control (optional accessory)	15
Parts and their functions	16
Camera unit	16
Wireless remote control: AW-RM50AG (optional accessory)	24
Setting the remote control IDs	26
Network settings	27
Using Easy IP Setup Software to make settings for the unit	27
Using EasyIP Setup Tool Plus to make settings for the unit	27
Setting the initial account	28
Installing the plug-in viewer software	29
Basic shooting operations	30
How to turn the power on and off	31
Turning the power on	31
Turning the power off	31
Selecting the units	32
Selecting the shooting modes (scene files)	33
Types of shooting modes	33
How to select the shooting mode	33
Shooting	35
What to do when encountering problems in the basic shooting operations	36
More advanced operations	37
Manual shooting	38
Manually adjusting the focus	38
Manually adjusting the iris	38
Manually adjusting the shutter speed	38
Manually adjusting the gain	38
Preset memories	39
White balance adjustment	40
Automatic adjustment (AWB: AWB A or AWB B)	40
Auto tracking white adjustment (ATW)	41
3200K and 5600K presets	41
VAR	41
Black balance adjustment	42
Automatic adjustment	42
Black level (master pedestal) adjustment	43
Genlock adjustment	44
Horizontal phase adjustment	44
Basic setup operations	45
When performing the operations using the wireless remote control ..	45
Camera menu items	46
Setting the camera menu items	46
Top Menu screen	46
Camera screen	47
Brightness 1/3 screen	47
Brightness 2/3 screen	48
Brightness 3/3 screen	49
Picture 1/3 screen	50
Picture 2/3 screen	51
Picture 3/3 screen	51
Matrix 1/5 screen	52
Matrix 2/5 screen	53
Matrix 3/5 screen	53
Matrix 4/5 screen	54
Matrix 5/5 screen	54
Lens screen	55
System 1/2 screen	56
System 2/2 screen	57
Output 1/5 screen	60
Output 2/5 screen	61
Output 3/5 screen	62
Output 4/5 screen	62
Output 5/5 screen	63
Pan/Tilt screen	63
P/T Acceleration screen	64
Preset 1/2 screen	66
Preset 2/2 screen	67
Preset Acceleration screen	67
Maintenance screen	70
Firmware Version 1/2 screen	70
Firmware Version 2/2 screen	71
IP Network screen	71
Scene Copy screen	72
Initialize screen	72
Hour Meter screen	73
HDMI Status screen	74
Error Status screen	75
Camera menu item table	76
Displaying the web screen	83
Displaying the web screen using a personal computer	83
Switching between the Live screen [Live] and Web setup screen [Setup]	85
Logging into the Web screen	85
Web screen operations	86
Live screen [Live]	86
Web screen configurations	91
Web setup screen [Setup]	91
Setting status screen [Setting status]	92
Basic screen [Basic]	93
Image screen [Image/Audio]	100
Collaboration capability [Linkage]	122
User management screen [User mng.]	124
Network setup screen [Network]	126
Maintenance screen [Maintenance]	142
Displaying the web screen using a personal computer equipped with a touch panel	146
Displaying the web screen using a mobile terminal	148
Camera control screen [Camera Control]	148
Limiters	150
Setting/releasing the limiters	151
Basic limiter operations	151
Setting the limiters	151
Releasing the limiters	151
Resetting the limiters	151
Safe mode	152
Concerning the safe mode	152
Detection of equipment trouble	152
Troubleshooting	153
Specifications	161
Index	163

Before use

Overview

- This product is an all-in-one pan-tilt head remote camera that supports 4K HDMI output and multi-format 3G/SDI.
- Equipped with an optical 24x zoom lens and 4K-compatible 1/2.5 type MOS sensor, it is possible to shoot high-quality images with a high degree of realism with the horizontal resolution of 1500 lines. With its built-in image-shake correction and night mode functions, the unit can shoot in a wide range of environments.
- This product is compatible with High Bandwidth NDI (hereafter, NDI) and NDI|HX version 2 technology of NewTek, Inc. The problem of IP transmission delay and image degradation of NDI|HX will be resolved with High Bandwidth NDI.
- The problem of operating noise in pan/tilt operations has been significantly reduced by adopting the Direct Drive system.
- The unit supports transmission of video to NewTek High Bandwidth NDI and NDI|HX version 2 compatible software applications and hardware devices over a network.
- When a controller is connected, camera operations can be performed smoothly via IP control or serial control.
- The unit features a night mode that exposes subjects to infrared rays, making it possible to shoot even under low-light conditions.
- When the unit is connected to a personal computer via an IP network, it can be operated via a web browser.
- Connection with a Panasonic camera controller is also possible via Panasonic's proprietary serial communication format.
- The unit is available in white (AW-UE80W) or black (AW-UE80K) to suit your intended application and environment.

Computer requirements

CPU	7th Generation Intel® Core™ (Kaby Lake or later) recommended
Memory	For Windows: 4 GB or more For Mac: 4 GB or more
Network function	100BASE-T/TX or 1000BASE-T, RJ-45 connector
Image display	Resolution: 1920 x 1080 pixels or more Color generation: True Color 24-bit or more
Supported operating systems and web browsers	For Windows: Microsoft® Windows® 10 Windows® Internet Explorer® 11 64-bit/32-bit Microsoft Edge Google Chrome
	For Mac: macOS v11.0.1 Safari 14.01 macOS v11.0.1 Google Chrome macOS v10.15 Google Chrome macOS v10.14 Google Chrome
	For iPhone, iPad: iOS Safari iPadOS
	For Android: Android OS Google Chrome
Other	Adobe® Reader® (for viewing the operating instructions available on the website)

IMPORTANT

- Failure to provide the required personal computer environment may slow down the delineation of the images on the screen, make it impossible for the web browser to work and cause other kinds of problems.

<NOTE>

- Depending on the software version of the unit, an update may be necessary.
- For the latest information on compatible operating systems and web browsers, visit the support desk at the following website.

<https://pro-av.panasonic.net/>

Disclaimer of warranty

IN NO EVENT SHALL Panasonic Corporation BE LIABLE TO ANY PARTY OR ANY PERSON, EXCEPT FOR REPLACEMENT OR REASONABLE MAINTENANCE OF THE PRODUCT, FOR THE CASES, INCLUDING BUT NOT LIMITED TO BELOW:

- ① ANY DAMAGE AND LOSS, INCLUDING WITHOUT LIMITATION, DIRECT OR INDIRECT, SPECIAL, CONSEQUENTIAL OR EXEMPLARY, ARISING OUT OF OR RELATING TO THE PRODUCT;
- ② PERSONAL INJURY OR ANY DAMAGE CAUSED BY INAPPROPRIATE USE OR NEGLIGENT OPERATION OF THE USER;
- ③ UNAUTHORIZED DISASSEMBLE, REPAIR OR MODIFICATION OF THE PRODUCT BY THE USER;
- ④ INCONVENIENCE OR ANY LOSS ARISING WHEN IMAGES ARE NOT DISPLAYED, DUE TO ANY REASON OR CAUSE INCLUDING ANY FAILURE OR PROBLEM OF THE PRODUCT;
- ⑤ ANY PROBLEM, CONSEQUENTIAL INCONVENIENCE, OR LOSS OR DAMAGE, ARISING OUT OF THE SYSTEM COMBINED BY THE DEVICES OF THIRD PARTY;
- ⑥ ANY DEMANDS FOR COMPENSATION, CLAIMS, ETC. OCCASIONED BY THE INFRINGEMENT OF PRIVACY BY INDIVIDUALS OR ORGANIZATIONS WHOSE IMAGES WERE SHOT BY THE USER BECAUSE THESE IMAGES (INCLUDING THE RECORDINGS MADE) WERE MADE AVAILABLE BY THE USER BECAUSE IN THE PUBLIC DOMAIN FOR SOME REASON OR OTHER OR BECAUSE THE IMAGES ENDED UP BEING USED FOR PURPOSES OTHER THAN THE ONE DESCRIBED ABOVE;
- ⑦ LOSS OF REGISTERED DATA CAUSED BY ANY FAILURE.

Network security

As the unit intended to be used while connected to a network, the following security risks exist.

- ① Leakage or theft of information through the unit
- ② Unauthorized operation of the unit by persons with malicious intent
- ③ Interference with or stoppage of the unit by persons with malicious intent

It is your responsibility to take precautions, such as those described below, to protect yourself against the above network security risks. Panasonic does not accept any responsibility for damage of this type.

- Use the unit in a network secured by a firewall, etc.
- If the unit is connected to a network that includes personal computers, make sure that the system is not infected by computer viruses or other malicious programs (using a regularly updated antivirus program, anti-spyware program, etc.).
- Protect your network against unauthorized access by restricting users to those who log in with an authorized user name and password.
- After accessing the unit as an administrator, be sure to close all web browsers.
- Change the administrator password periodically.
- To avoid passwords that can be guessed easily by third parties, set a password of at least 8 characters in length, including at least 3 different types of characters, such as upper case, lower case, numbers, and symbols.
- Restrict access to the unit by authenticating the users, for example, to prevent setting information stored on the unit from leaking over the network.
- Do not install the unit in locations where the unit, cables, and other parts can be easily damaged or destroyed by persons with malicious intent.
- Avoid connections that use public lines.

<NOTE>

Notes on user authentication

- User authentication on the unit can be performed via digest authentication or basic authentication. If basic authentication is used without the use of a dedicated authentication device, password leaks may occur. We recommend using digest authentication or host authentication.

Usage restrictions

- We recommend connecting the unit, controller, and any computers to the same network segment. Events based on settings inherent to the network devices, for example, may occur in connections that include different segments, so be sure to perform checks prior to operation.

Features

■ Multi-format support

- You can switch between the following formats via the camera menus or a web browser.

[4K format (only HDMI output supported)]

2160/59.94p, 2160/50p, 2160/29.97p*1, 2160/25p*1, 2160/24p*1, 2160/23.98p*1

[HD format (SDI supported)]

1080/59.94p, 1080/50p, 1080/59.94i, 1080/50i, 1080/29.97p*1, 1080/25p*1, 1080/23.98p*2, 1080/29.97PsF, 1080/25PsF, 1080/23.98PsF, 1080/24p*1, 1080/23.98p*1, 720/59.94p, 720/50p

[HD format (HDMI supported)]

1080/59.94p, 1080/50p, 1080/59.94i, 1080/50i, 1080/29.97p*1, 1080/25p*1, 1080/23.98p*3, 1080/24p*1, 1080/23.98p*1, 720/59.94p, 720/50p

*1 Native output

*2 OVER 59.94i output (your monitor may recognize the signal as 59.94i).

*3 OVER 59.94p output (your monitor may recognize the signal as 59.94p).

■ 1/2.5-type 4K MOS sensor and high-performance 24x zoom lens featured

- The latest 1/2.5-type 4K MOS sensor and DSP (Digital Signal Processor) are incorporated. High-quality pictures are obtained by video processing in many different kinds of ways.
- In addition to its optical 24x zoom lens, the unit comes with a 10x digital zoom to achieve high-quality images that overflow with ambiance. Zoom up to 36x is possible (up to 28x in 4K mode) while maintaining the picture quality with the use of iZoom.
- A dynamic range stretcher (DRS) function that compensates for overexposure and loss of dark detail and a digital noise reduction (DNR) function for minimizing image lag even in dark locations and shooting scenes clearly are incorporated to reproduce clean and clear images in a wide range of applications.
- Even if the camera has to be installed in a limited space, a wide range can be covered due to the possibility of wide-angle shooting across 74.1° horizontally.

■ Easy operation of unit enabled by its integration with a high-performance pan-tilt head unit

- Operations at the high speed of 180°/s
- Wide rotational angles with a panning range of ±175° and a tilting range from -30° to 90°
- Quiet operation with noise levels of NC25 or less
- Storage of up to 100 positions in the preset memory (The number of preset memories that can be used varies from one controller to another.)

■ Built-in night mode

- The unit supports infrared shooting. By exposing subjects to infrared rays, shooting under ordinarily difficult low-light conditions is possible. (Image output will be in black and white.)
- The iris will be fixed at open.

■ Supports optical image stabilization (O.I.S.)

- Image stabilization is implemented if shaking of the unit is detected, thus reducing shaking of the images. Optical image stabilization means less image deterioration, making highly precise vibration mitigation possible.

■ IP image output functions

- The unit is equipped with image compression and IP transmission LSI capabilities. Output at a maximum of 60 frames each second is possible at full HD picture quality.
- Operation with IP control allows for a wide range of applications, such as controlling the camera from remote locations.

■ High degree of compatibility with Panasonic's currently available controllers, enabling a flexible system to be put together

- A maximum of five units can be operated by serial control from one of Panasonic's currently available controllers (AW-RP150, AW-RP60).

The unit can also be used together with the cameras and pan-tilt head unit systems currently available from Panasonic Corporation so that an existing system can be used to advantage to put together a system that is even more flexible.

<NOTE>

- It may be necessary to upgrade the version of the controllers in order to support the unit. For details on upgrading, visit the support page on the following website.

<https://pro-av.panasonic.net/>

The maximum distances between the units and controller is 1000 meters (3280 ft). (when serial control is exercised)

Use of an external device or some other means must be provided separately in order to extend the video signal connections.

■ Easy construction of systems thanks to integrated design used for pan-tilt head, camera and lens

- By integrating the camera, lens and pan-tilt head into a single unit, it is now easier to construct systems.

■ Use of easy-to-operate wireless remote control (optional accessory) is possible

- A wireless remote control capable of operating up to four units can be used.

It can easily be used to set the various functions or switch between them while viewing the menu screens.

■ Flexible camera layout enabled by simple connection and installation

- This unit features excellent connectivity and installability thanks to the IP control; a lightweight main unit, and the turn-lock mechanism, which enables the user to install it on his or her own (only when used indoors).

<NOTE>

- Bear in mind that this unit is designed to be used indoors only: It cannot be used outdoors.

■ While including a 4K-compatible or different kinds of interface, the unit still has the same installation footprint as previous models

- The unit maintains the compact installation footprint of previous models.

■ Easy connections and settings courtesy of IP control

- Up to two hundred units can be operated by IP connection from a Panasonic controller (AW-RP150, AW-RP60). (The maximum length of the LAN cables is 100 meters (328 ft).)
- Network connection with AW-RP150 or AW-RP60 requires setup of an initial account. (→ page 28) When an initial account is not set up, AW-RP150 or AW-RP60 can detect but cannot control this unit.

Features (continued)

■ PoE++ *4 eliminates need for camera power configurations

- Configurations for camera's power supply are not necessary when the unit is connected to a network device that supports the PoE++ standard (IEEE 802.3bt compliant)*5. Software authentication (LLDP) is also supported, but it may be necessary to make settings on the network device (IEEE 802.3bt compliant)*5.

<NOTE>

- If the AC adaptor and a PoE++ power supply are connected simultaneously, the AC adaptor will have priority. If the AC adaptor is disconnected while both power supplies are connected, the unit will restart automatically, and the image will be interrupted.
- Use a Category 5e cable or higher when using a PoE++ power supply. The maximum length of the cable between the power supply unit and the unit is 100 meters (328 ft). Using a cable that is lower than Category 5e may result in reduced power supply capabilities.







*4 Power over Ethernet Plus Plus. Referred to as "PoE++" in this manual.

*5 For details on PoE++ power supply devices for which operation has been verified, consult your local dealer.

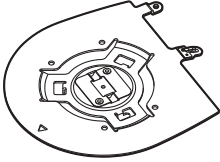
Accessories

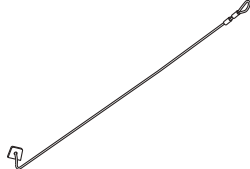
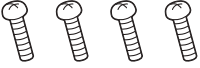
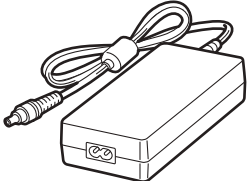
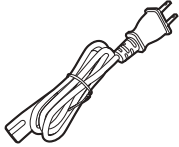
Check that the following accessories are present and accounted for.

- After removing the product from its container, dispose of the power cable cap (if supplied) and packing materials in an appropriate manner.

<p>Mount bracket for installation surface (Hanging/Desktop) (1)</p> 	<p>Main unit mounting screw (with flat washer, spring washer) M3×6 mm (1/4 inches) (1)</p> 	<p>Drop-prevention wire (1) Drop-prevention wire mounting screw (1) (comes attached to the unit)</p> 
<p>Bracket mounting screws (bind-head) M4×10 mm (13/32 inches) (4)</p> 	<p>AC adaptor (1)</p> 	
<p>Power cable for AW-UE80WP, AW-UE80KP (1)</p> 	<p>for AW-UE80WE, AW-UE80KE (2)</p> <ul style="list-style-type: none"> For U.K. and Saudi Arabia  <ul style="list-style-type: none"> For Continental Europe, etc. 	<p>for AW-UE80WED, AW-UE80KED (1)</p> <ul style="list-style-type: none"> For India only 

Optional accessories

- Wireless remote control AW-RM50AG (Size "AA" dry battery x 2, obtained separately)
- Direct ceiling mount bracket WV-Q105A

<NOTE>

- For details on optional accessories, refer to the catalog or consult your local dealer.

Operating precautions

■ Do not use the unit in oily-smoky or dusty places.

Performance may be adversely affected if small particles or other foreign objects get inside the product.

Take extra care in environments where a special effect such as theatrical smoke is used.

■ Do not allow foreign matter to make contact with the rotating parts.

Failure to obey may cause the unit to malfunction.

■ Maintenance

Turn off the unit's power before proceeding with maintenance.

Failure to obey may result in injuries.

Wipe the surfaces using a soft dry cloth. Avoid all contact with benzene, paint thinners and other volatile substances, and avoid using these substances. Otherwise, the casing may become discolored.

■ Hold the bottom surface with both hands for picking up this unit.

If you hold the lens part or the sides, it will put a load strain on the motor and cause a malfunction.

■ Do not turn the camera head by hand.

Turning the camera head by hand may cause the unit to malfunction.

■ About the lens/pan-tilt head

If the lens, pan-tilt head, and other parts are not operated for a long period of time, the viscosity of the grease applied inside them may increase and operation may become no longer possible. Move the lens and pan/tilt head regularly.

■ Shoot under the proper lighting conditions.

To produce pictures with eye-pleasing colors, shoot under the proper lighting conditions.

The pictures may not appear with their proper colors when shooting under fluorescent lights. Select the proper lighting as required.

■ To ensure a stable performance in the long term

Using the unit for prolonged periods in locations where the temperature and humidity levels are high will cause its parts to deteriorate, resulting in a reduction of its service life.

(Recommended temperature: Max. 35 °C (95 °F))

Ensure that a cooling unit or heating unit will not blow any air directly toward the installation location.

■ Do not point the camera at strong lights.

When parts of the MOS sensor are exposed to spotlights or other strong lights, blooming (a phenomenon where the edges of strong lights become blurred) may occur.

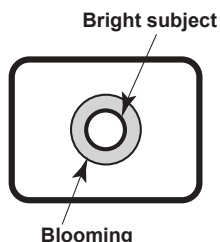

■ What happens with high-brightness subjects

Flare may occur if an extremely bright light source is pointed at the lens. In a case like this, change the angle or take some other remedial action.

■ When using the automatic functions

- In the [Scene] such as the camera menu, the initial settings on some items has been set to auto, making it impossible for these items to be operated manually. To operate them manually, switch from the auto settings to the manual settings as required.
- When using the ATW (auto tracking white adjustment) function under fluorescent lights, the white balance may vary.
- In some situations, it may be hard to focus at the auto setting. In cases like this, select the manual setting, and focus manually.

■ Zooming and focusing

When the focus is set manually, out-of-focusing may occur during zooming.

After zooming, if necessary, either adjust the focus or set the focus to auto.

When using the focus at the manual setting, proceed with zooming after setting the focus position at the Tele end where the focusing accuracy is higher. (However, if the distance from the unit to the subject is less than 1.2 meters (3.9 ft), the subject may shift out of focus at the Wide end.)

If zooming is performed to the Tele end after having adjusted the focus at the Wide end, out-of-focusing may occur.

■ Operation of the lens when the power is turned on

When the unit's power is turned on, the zoom, focus and iris are adjusted automatically.

■ The unit comes with the safe mode.

The safe mode is function designed to protect the unit from damage. For details, refer to "Concerning the safe mode" (→ page 153).

■ Concerning the HDMI interface standard

This unit has been certified as HDMI-compatible, but on rare occasions images may not be displayed depending on the HDMI device which has been connected to the unit.

■ Color bars

Color bars are used to adjust the color phase, and the widths and positions of these bars may differ from other models.

■ H.264/H.265 patent pool licensing

This product is licensed based on the AVC Patent Portfolio License, and the license does not extend beyond uses by users, who engage in the acts described below, for their own personal and non-profit applications.

- (i) Recording of image information in compliance with the AVC standard (hereafter, "AVC videos")
- (ii) Playing of AVC videos recorded by consumers engaging in personal activities or AVC videos acquired from licensed providers

For details, visit MPEG LA, LLC website (<http://www.mpegla.com>).

■ Concerning PoE++ power supply

The unit complies with the IEEE 802.3bt.

Use a compatible Ethernet hub and PoE++ injector to use a PoE++ power supply.

Software authentication (LLDP) complies with IEEE 802.3bt, but it may be necessary to make settings on the network device.

For details on Ethernet hubs and PoE++ injectors for which operations have been verified, consult your local dealer.

■ Turn off the power before connecting or disconnecting the cables.

This unit is not equipped with a power switch.

Disconnect the AC adaptor power plug or turn off the PoE++ power supply device before connecting or disconnecting cables.

■ When the unit is not in use

Turn off the unit's power when it is not in use.

When the unit is no longer to be used, make sure to remove the camera and mount bracket rather than leaving them in place.

■ Do not touch the optical system parts.

The optical system parts are vital to the operation of the camera. Under no circumstances must they be touched.

In the unlikely event that they have become dusty, remove the dust by using a camera blower or by wiping them gently with a lens cleaning paper.

■ Do not point the camera directly at the sun or a laser beam no matter whether it is turned on or not.

Taking images of the sun, laser beams, or other brightly lit subjects for prolonged periods of time may damage the CCD.

■ Personal computer used

If the same image is displayed for a prolonged period on a personal computer's monitor, the monitor may be damaged. Use of a screen saver is recommended.

■ Concerning the IP address setting

Do not run the Easy IP Setup Software on a multiple number of personal computers for a single camera and set the IP address at the same time.

Otherwise, you will be unable to complete the proper procedure and set the IP address correctly.

■ About consumables

The following parts are consumables. Replace them using the lifespans as a guide.

The lifespans may vary depending on the operating environment and operating conditions. The lifespans are a guide for when the unit is used at 35 °C (95 °F).

- Cooling fan: Approx. 15000 hours

Contact your dealer regarding replacements.

■ Disposal of the unit

When the unit has reached the end of its service life and is to be disposed of, ask a qualified contractor to dispose of the unit properly in order to protect the environment.

■ Remove lens cap and pan stopper when turning on power

Make sure you remove the lens cap and pan stopper when turning on the power.

If there is an error, turn the power on again after removing the lens cap and pan stopper.

■ Transportation

The camera unit is constructed to rotate easily. As malfunctions in camera movement may occur, transport after securing the camera unit so that it does not rotate.

- ① Face the lens down, then secure the lens part and camera head together with tape.
- ② Use tape to secure the camera head and pedestal in several locations.

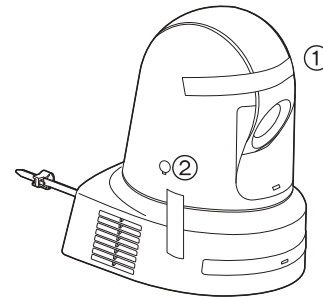

- The lens cap and pan stopper are not intended to guarantee protection of the camera unit during transport. When transporting the unit, be sure to use tape to secure it.

■ Moving the unit

- When carrying the unit, take care not to apply strong shocks or drop it.
- Remove connection cables when moving the unit.
- Turn off the system power when moving the unit.
- Wrap the unit in cushioning material, etc., when moving the unit so that impacts do not damage it.
- Treat the unit carefully so that vibrations or impacts do not damage it.

■ Concerning the installation location

Install the unit in a stable location which will not be susceptible to shaking. If the unit is installed in a location which is susceptible to shaking, this will cause the unit's images to shake in turn.

Install the unit after conferring in detail with your dealer.

Install the unit on a ceiling that is strong enough (such as a concrete ceiling).

If the unit is to be installed on a ceiling which is not strong enough, reinforce the ceiling sufficiently first.

Through the adoption of the Direct Drive system and Panasonic proprietary technology, we have achieved quietness and high precision in panning and tilting.

In order to get the most from the characteristics of the Direct Drive system, install in a stable location that does not shake and that has sufficient stiffness. Shaking of the installation location can be the cause of performance deterioration and malfunctions in the camera.

If the camera is installed in a location with insufficient stiffness, the pan and tilt control characteristics may be adversely affected, leading to unstable operation.

- In environments such as the following, there may be unusual operation sounds during pan and tilt, and operational errors may occur.

If you are concerned about unstable pan and tilt operations after installation, please contact your dealer.

<Installation examples that may cause performance deterioration and malfunctions>

- A Single point attachment to a cylindrical pole structure that has a small diameter
- B Single point attachment to a movable structure

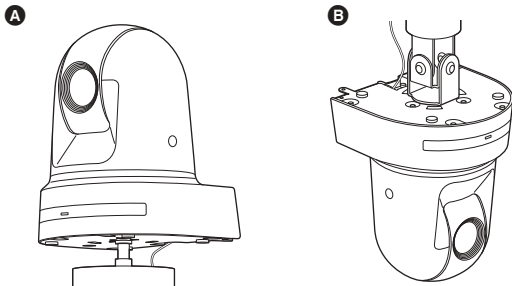

■ Information on software used with this product

This product includes GNU General Public License (GPL) and GNU Lesser General Public License (LGPL) licensed software, and the customer is entitled to obtain, modify, or redistribute the source code for the software.

This product includes MIT Licensed software.

This product includes BSD Licensed software.

For details on obtaining the source codes, visit the following website.

<https://pro-av.panasonic.net/>

However, do not contact Panasonic for questions regarding obtained source codes.

Wireless remote control (optional accessory)

This unit can be operated by remote control using a wireless remote control (model number: AW-RM50AG) purchased separately.

Check out the following points before using the wireless remote control.

- Point the wireless remote control at the unit's wireless remote control signal light-sensing area (front panel or back panel), and operate it within a range of 10 meters (32.8 ft) from these areas.

- Refer to <Layout of wireless remote control signal light-sensing areas> on the right.

- The signal sensing distance is reduced if the angle at which the wireless remote control signals are sensed is increased.

The light-sensing sensitivity is reduced to about one-half when the wireless remote control is pointed at an angle of 40 degrees from each position in front of a wireless remote control signal light-sensing area (front panel or back panel).

If the remote control is operated from the behind the unit, it may be either difficult or impossible to perform the desired operations.

- If the unit is installed near fluorescent lights, plasma monitors or other such products or if the unit is exposed to sunlight, the effects of the light may make it impossible for the unit to be operated using the wireless remote control.

Be sure to follow the steps below for installation and use.

- Take steps to ensure that the wireless remote control signal light-sensing area will not be exposed to the light from fluorescent lights, plasma monitors or other such products or from the sun.
- Install the unit away from fluorescent lights, plasma monitors and other such products.

- For about 10 minutes even after the batteries have been removed from the wireless remote control, the selection of the operation to be performed (the CAMERA <1>, <2>, <3> or <4> button which was pressed last) will remain stored in the memory.

When a longer period of time elapses, however, the selection is reset to the status established when the CAMERA <1> button was pressed.

<Layout of wireless remote control signal light-sensing areas>

<NOTE>

- The arrows in the figure below show the light-sensing directions in which the wireless remote control signals travel.

Wireless remote control signal light-sensing area (back panel, 1 place)

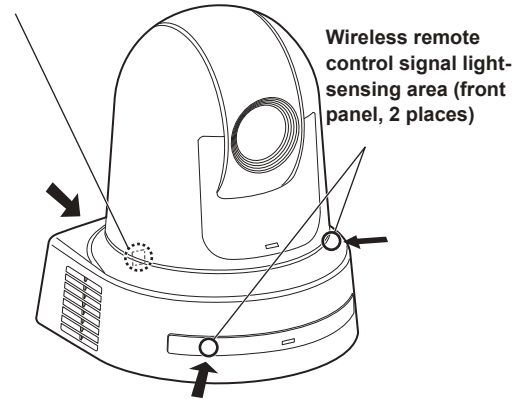

• Top view

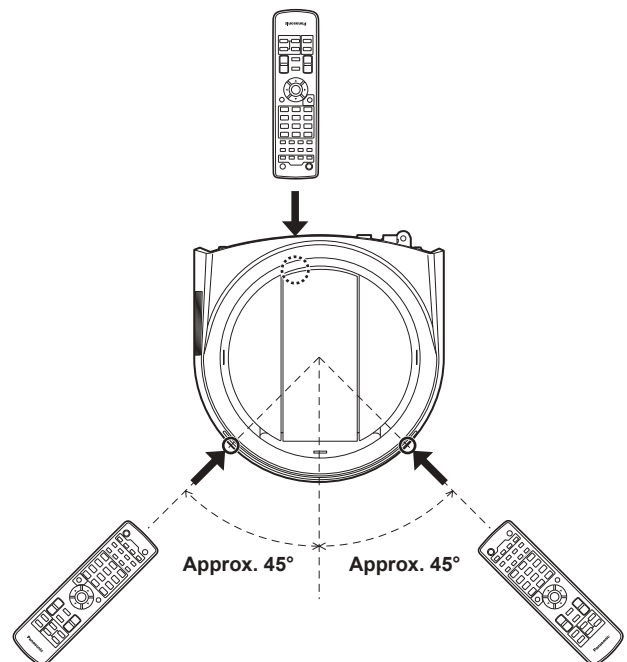

• Rear panel view

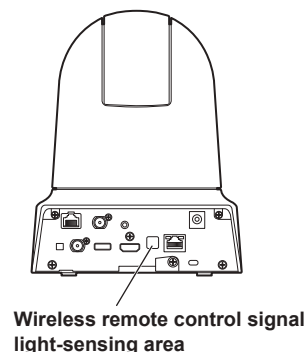

Parts and their functions

Camera unit

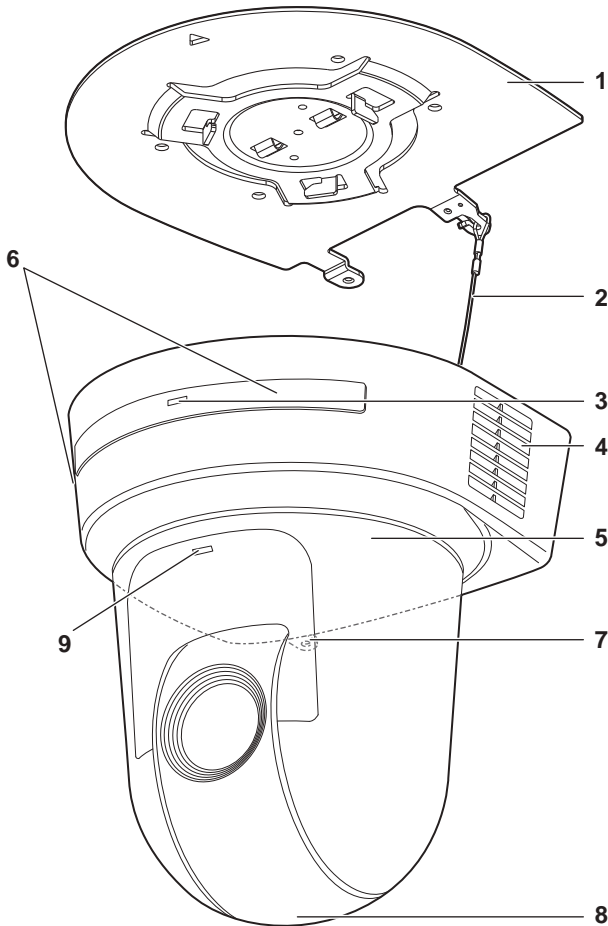

Rear panel

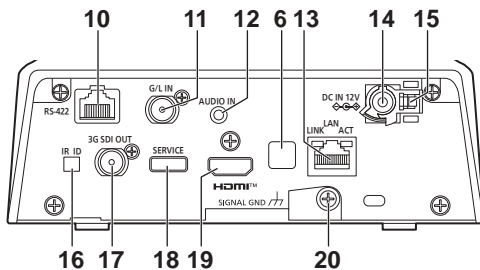

Bottom panel

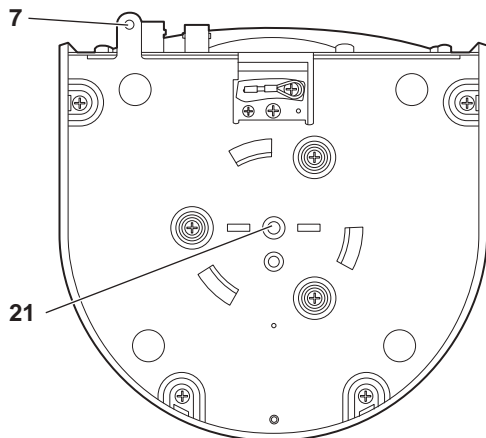

1. Mount bracket for installation surface (supplied accessory)

Mount this bracket onto the installation surface, and then attach the camera main unit to the bracket.

2. Drop-prevention wire

This wire is screwed down to the bottom panel of the camera main unit. Loop the circle part of the wire around the hook of the mount bracket.

3. Status display lamp

This lights in the following way depending on the status of the unit.

Orange	Light up	When the standby status is established
	Blink twice	When a signal not matched by the remote control ID has been received from the wireless remote control (optional accessory) while the power is on
Green	Light up	When the power is on
	Blink twice	When a signal matched by the remote control ID has been received from the wireless remote control (optional accessory) while the power is on
	Blinking rapidly	When the initialization process is complete
Red	Light up	When trouble has occurred in the unit
	Blinking slowly	Firmware being updated
	Blinking rapidly	When a PoE++ software authentication error has occurred

4. Ventilation holes

Blocking the ventilation holes may cause a malfunction. Make sure there is sufficient space around the ventilation holes.

5. Pan head

This rotates in the right and left direction.

6. Wireless remote control signal light-sensing area

There are three light-sensing areas on the front and rear panels of the camera pedestal.

7. Hole for securing the camera pedestal

This hole is provided in the bottom panel of the camera pedestal.

8. Camera head

This rotates in the up and down direction.

9. Tally lamp

This comes on or goes off in response to the control from the controller but only when "On" has been selected as the tally lamp use setting. The tally lamp is red or green.

Red	Light up	When receiving a red tally signal
	Blink once	When a Pan/Tilt limit is set
	Blink twice	When the Pan/Tilt limit is canceled
	Blink three times	When start up of this unit is complete
Green	Light up	When receiving a green tally signal

Parts and their functions (continued)

10.RS-422 connector <RS-422>

This RS-422 connector (RJ-45) is connected when exercising serial control over the unit from an external device. Use a cable with the following specifications for the connection to this connector. Furthermore, by shorting the R-TALLY signal (2-pin) with the GND (1-pin), it is possible to light the tally lamp (red) in the camera head section of the unit.

<NOTE>

- Do not connect PoE cable to the RS-422 port.
- Do not apply a voltage to the R_TALLY_IN signal pin.
- With the menu settings, the ON/OFF for red tally signals or green tally signals received by this unit can be output via pin 7 or pin 8. Output is by contact output, and normally is "OPEN", then it becomes "MAKE" for output. (→ page 63)

LAN cable*1 (category 5e or above, straight cable), STP, max. 1000 m (3280 ft)

*1 Use of an STP (shielded twisted pair) cable is recommended.



Pin No.	Signal	Pin No.	Signal
1	GND	5	TXD+
2	R_TALLY_IN	6	RXD+
3	RXD-	7	OPTION_OUT1
4	TXD-	8	OPTION_OUT2

■ Example OPTION_OUT1, OPTION_OUT2 connector connections

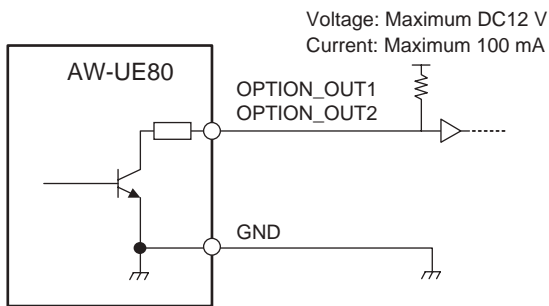

11.G/L IN connector <G/L IN>

This is the external sync signal input connector.

This unit supports BBS (Black Burst Sync) and tri-level synchronization.

Supply to this connector the signals that correspond to the video signal format which has been set.

Frequency: 59.94 Hz, 29.97 Hz

Format	External sync signal input format	
	Tri-level sync	BBS
2160/59.94p	—	1080/59.94i
2160/29.97p	1080/29.97p 1080/29.97PsF	480/59.94i
1080/59.94p	—	
1080/59.94i	—	
1080/29.97p	1080/29.97p 1080/29.97PsF	
1080/29.97PsF	1080/29.97p 1080/29.97PsF	
1080/23.98p over 59.94i	—	
720/59.94p	720/59.94p	

Frequency: 50 Hz, 25 Hz

Format	External sync signal input format	
	Tri-level sync	BBS
2160/50p	—	1080/50i
2160/25p	1080/25p 1080/25PsF	576/50i
1080/50p	—	
1080/50i	—	
1080/25p	1080/25p 1080/25PsF	
1080/25PsF	1080/25p 1080/25PsF	
720/50p	720/50p	

Frequency: 24 Hz

Format	External sync signal input format	
	Tri-level sync	
2160/24p	1080/24p	
1080/24p	1080/24PsF	

Frequency: 23.98 Hz

Format	External sync signal input format	
	Tri-level sync	
2160/23.98p	1080/23.98p	
1080/23.98p	1080/23.98PsF	
1080/23.98PsF		

12.AUDIO IN connector <AUDIO IN>

Inputs external audio (microphone, line).

13.LAN connector for IP control <LAN LINK/ACT>

This LAN connector (RJ-45) is connected when exercising IP control over the unit from an external device. Use a LAN cable*1 (category 5e or above, STP, max. 100 m (328 ft)) for connection.

*1 Use of an STP (Shielded Twisted Pair) cable is recommended.

14.DC IN connector <12V IN>

Connect the AC adaptor supplied with the unit to this connector to supply the DC 12 V voltage to the unit.

■ AC adaptor

Be sure to use the supplied AC adaptor.

Parts and their functions (continued)

15. Cable clamp

This is used to hold the cable connection to the DC IN connector and prevent it from becoming disconnected.

16. IR ID switches <IR ID>

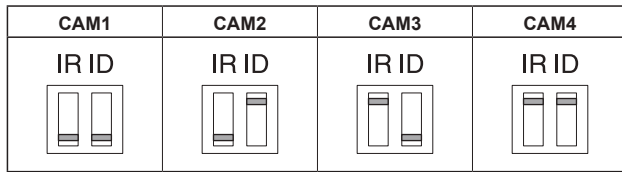

These are used to select the ID of the wireless remote control (optional accessory). (→ page 26)

The IR ID switch settings “CAM1” to “CAM4” correspond to the <CAM1> to <CAM4> buttons on the wireless remote control.

17. 3G SDI OUT connector <3G SDI OUT>

This is an SDI video signal output connector. Depending upon the output signal format, 3G-SDI or 1.5G-SDI signals are output.

18. Service switches <SERVICE>

Perform switch settings before turning the unit on.

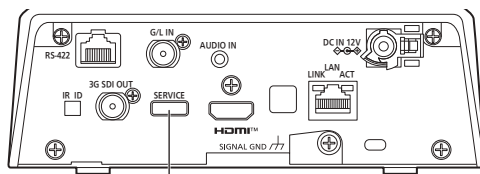

Service switches

	Function	Factory settings
SW1	Switches for initialization (Refer to the explanations in “Initialization 1” and “Initialization 2”)	OFF
SW2	Always leave at OFF (used for factory adjustments)	OFF
SW3		OFF
SW4		OFF

Initialization 1

- Reset the user authentication settings and host authentication settings for network connection. (This will delete all the registered user information (IDs/passwords) and host information (IP addresses).)
- With the IR ID switches and service switches set as shown below, turn on the power of the unit.

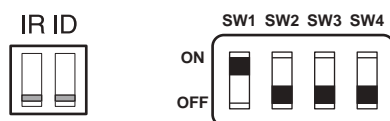

<NOTE>

- When initialization is complete, the status display lamp on the front of the unit blinks green. Set the service switches back to their original positions (SW1 to SW4 all OFF), then restart the unit.

Initialization 2

- The unit is reset to the state it was in at the time of purchase. (All camera menu setting values and network setting values are reset.)
- With the IR ID switches and service switches set as shown below, turn on the power of the unit.

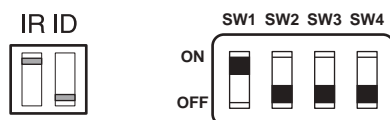

<NOTE>

- When initialization is complete, the status display lamp on the front of the unit blinks green. Set the service switches back to their original positions (SW1 to SW4 all OFF), then restart the unit.

19. HDMI connector <HDMI>

This is the HDMI video output connector.

20. Ground connector

Connects to the ground connector on a wall outlet, ground bar, etc. for grounding. (→ page 6)

21. Tripod screw holes

(Screw: 1/4-20 UNC, ISO 1222 [6.35 mm])

Use these screw holes when securing the unit to a tripod, etc.

Place the tripod on a completely flat and level surface.

Tighten the screws by hand to mount the tripod securely.

Use screw for mounting the tripod that satisfy the following standard.

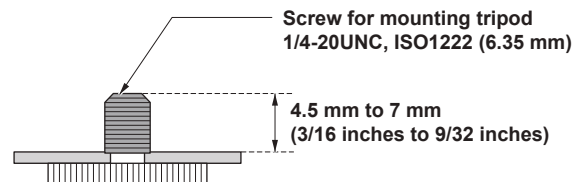

Parts and their functions (continued)

■ Output conditions for each video format

Frequency	System Format	HDMI	3G SDI OUT	NDI
59.94Hz	2160/59.94p	2160/59.94p 1080/59.94p	1080/59.94p 1080/59.94i	1080/59.94p
	2160/29.97p	2160/29.97p 1080/29.97p	1080/29.97p	1080/29.97p
	1080/59.94p	1080/59.94p	1080/59.94p 1080/59.94i	1080/59.94p
	1080/59.94i	1080/59.94i	1080/59.94i	1080/59.94p
	1080/29.97p	1080/29.97p	1080/29.97p	1080/29.97p
	1080/29.97PsF	1080/29.97p	1080/29.97PsF	No output
	1080/23.98p over 59.94i	1080/23.98p over 59.94p	1080/23.98p over 59.94i	No output
720/59.94p	720/59.94p	720/59.94p	720/59.94p	
50Hz	2160/50p	2160/50p 1080/50p	1080/50p 1080/50i	1080/50p
	2160/25p	2160/25p 1080/25p	1080/25p	1080/25p
	1080/50p	1080/50p	1080/50p 1080/50i	1080/50p
	1080/50i	1080/50i	1080/50i	1080/50p
	1080/25p	1080/25p	1080/25p	1080/25p
	1080/25PsF	1080/25p	1080/25PsF	No output
	720/50p	720/50p	720/50p	720/50p
24Hz	2160/24p	2160/24p 1080/24p	1080/24p	1080/24p
	1080/24p	1080/24p	1080/24p	1080/24p
23.98Hz	2160/23.98p	2160/23.98p 1080/23.98p	1080/23.98p	1080/23.98p
	1080/23.98p	1080/23.98p	1080/23.98p	1080/23.98p
	1080/23.98PsF	1080/23.98p	1080/23.98PsF	No output

■ IP video transmission output (multi-channel display)

- When “Streaming mode” is set to “H.265”

Settings		H.265(1)	H.265(2)	H.264(1)	H.264(2)	H.264(3)	H.264(4)	JPEG(1)	JPEG(2)	JPEG(3)
Resolution		1920x1080 1280x720	1920x1080 1280x720 640x360	—	—	—	—	1920x1080 1280x720 640x360 320x180	640x360 320x180	640x360 320x180
Frame rate	System frequency 59.94Hz	60fps 30fps	60fps 30fps	—	—	—	—	30fps 15fps 5fps 1fps	30fps 15fps 5fps 1fps	30fps 15fps 5fps 1fps
	System frequency 50Hz	50fps 25fps	50fps 25fps	—	—	—	—	25fps 12.5fps 5fps 1fps	25fps 12.5fps 5fps 1fps	25fps 12.5fps 5fps 1fps
	System frequency 29.97Hz	30fps	30fps	—	—	—	—	30fps 15fps 5fps 1fps	30fps 15fps 5fps 1fps	30fps 15fps 5fps 1fps
	System frequency 25Hz	25fps	25fps	—	—	—	—	25fps 12.5fps 5fps 1fps	25fps 12.5fps 5fps 1fps	25fps 12.5fps 5fps 1fps
	System frequency 24/23.98Hz	24fps	24fps	—	—	—	—	24fps 12fps 4fps 1fps	24fps 12fps 4fps 1fps	24fps 12fps 4fps 1fps

- If the resolution is 640x360, 60fps and 50fps cannot be selected.
- If the system frequency is 24/23.98Hz, the resolution for H.265 will be 1920x1080 only.
- You cannot make settings above the resolution and frame rate set by the system format.

- When “Streaming mode” is set to “SRT(H.265)”

Settings		H.265(1)	H.265(2)	H.264(1)	H.264(2)	H.264(3)	H.264(4)	JPEG(1)	JPEG(2)	JPEG(3)
Resolution		1920x1080 1280x720	—	—	—	—	—	1920x1080 1280x720 640x360 320x180	640x360 320x180	640x360 320x180
Frame rate	System frequency 59.94Hz	60fps 30fps	—	—	—	—	—	30fps 15fps 5fps 1fps	30fps 15fps 5fps 1fps	30fps 15fps 5fps 1fps
	System frequency 50Hz	50fps 25fps	—	—	—	—	—	25fps 12.5fps 5fps 1fps	25fps 12.5fps 5fps 1fps	25fps 12.5fps 5fps 1fps
	System frequency 29.97Hz	30fps	—	—	—	—	—	30fps 15fps 5fps 1fps	30fps 15fps 5fps 1fps	30fps 15fps 5fps 1fps
	System frequency 25Hz	25fps	—	—	—	—	—	25fps 12.5fps 5fps 1fps	25fps 12.5fps 5fps 1fps	25fps 12.5fps 5fps 1fps

- The SRT(H.265) transmission mode (Transmission priority) cannot be selected.
- It is not possible to select SRT(H.265) mode when the system frequency is 24/23.98Hz.
- You cannot make settings above the resolution and frame rate set by the system format.

Parts and their functions (continued)

• When “Streaming mode” is set to “H.264”

Settings		H.265(1)	H.265(2)	H.264(1)	H.264(2)	H.264(3)	H.264(4)	JPEG(1)	JPEG(2)	JPEG(3)
Resolution		—	—	1920x1080 1280x720	1920x1080 1280x720 640x360 320x180	1280x720 640x360 320x180	1280x720 640x360 320x180	1920x1080 1280x720 640x360 320x180	640x360 320x180	640x360 320x180
Frame rate	System frequency 59.94Hz	—	—	60fps 30fps 15fps 5fps	60fps 30fps 15fps 5fps	30fps 15fps 5fps	30fps 15fps 5fps	30fps 15fps 5fps 1fps	30fps 15fps 5fps 1fps	30fps 15fps 5fps 1fps
	System frequency 50Hz	—	—	50fps 25fps 12.5fps 5fps	50fps 25fps 12.5fps 5fps	25fps 12.5fps 5fps	25fps 12.5fps 5fps	25fps 12.5fps 5fps 1fps	25fps 12.5fps 5fps 1fps	25fps 12.5fps 5fps 1fps
	System frequency 29.97Hz	—	—	30fps 15fps 5fps	30fps 15fps 5fps	30fps 15fps 5fps	30fps 15fps 5fps	30fps 15fps 5fps 1fps	30fps 15fps 5fps 1fps	30fps 15fps 5fps 1fps
	System frequency 25Hz	—	—	25fps 12.5fps 5fps	25fps 12.5fps 5fps	25fps 12.5fps 5fps	25fps 12.5fps 5fps	25fps 12.5fps 5fps 1fps	25fps 12.5fps 5fps 1fps	25fps 12.5fps 5fps 1fps
	System frequency 24/23.98Hz	—	—	24fps	24fps	—	—	24fps 12fps 4fps 1fps	24fps 12fps 4fps 1fps	24fps 12fps 4fps 1fps

- If the resolution is 640x360 or 320x180, 60fps and 50fps cannot be selected.
- You cannot make settings above the resolution and frame rate set by the system format.
- If either [Main profile] or [Baseline profile] has been selected in [Profile type], 640x360 and 320x180 cannot be selected.

• When “Streaming mode” is set to “SRT(H.264)”

Settings		H.265(1)	H.265(2)	H.264(1)	H.264(2)	H.264(3)	H.264(4)	JPEG(1)	JPEG(2)	JPEG(3)
Resolution		—	—	1920x1080 1280x720	—	—	—	1920x1080 1280x720 640x360 320x180	640x360 320x180	640x360 320x180
Frame rate	System frequency 59.94Hz	—	—	60fps 30fps 15fps 5fps	—	—	—	30fps 15fps 5fps 1fps	30fps 15fps 5fps 1fps	30fps 15fps 5fps 1fps
	System frequency 50Hz	—	—	50fps 25fps 12.5fps 5fps	—	—	—	25fps 12.5fps 5fps 1fps	25fps 12.5fps 5fps 1fps	25fps 12.5fps 5fps 1fps
	System frequency 29.97Hz	—	—	30fps 15fps 5fps	—	—	—	30fps 15fps 5fps 1fps	30fps 15fps 5fps 1fps	30fps 15fps 5fps 1fps
	System frequency 25Hz	—	—	25fps 12.5fps 5fps	—	—	—	25fps 12.5fps 5fps 1fps	25fps 12.5fps 5fps 1fps	25fps 12.5fps 5fps 1fps

- The available options for the SRT(H.264) transmission mode (Transmission priority) are limited to 30fps or lower (excluding 24fps).
- It is not possible to select SRT(H.264) mode when the system frequency is 24/23.98Hz.
- You cannot make settings above the resolution and frame rate set by the system format.

Parts and their functions (continued)

- When “Streaming mode” is set to “RTMP”

Settings		H.265(1)	H.265(2)	H.264(1)	H.264(2)	H.264(3)	H.264(4)	JPEG(1)	JPEG(2)	JPEG(3)
Resolution		—	—	1920x1080 1280x720	—	—	—	1920x1080 1280x720 640x360 320x180	640x360 320x180	640x360 320x180
Frame rate	System frequency 59.94Hz	—	—	60fps 30fps 15fps 5fps	—	—	—	30fps 15fps 5fps 1fps	30fps 15fps 5fps 1fps	30fps 15fps 5fps 1fps
	System frequency 50Hz	—	—	50fps 25fps 12.5fps 5fps	—	—	—	25fps 12.5fps 5fps 1fps	25fps 12.5fps 5fps 1fps	25fps 12.5fps 5fps 1fps
	System frequency 29.97Hz	—	—	30fps 15fps 5fps	—	—	—	30fps 15fps 5fps 1fps	30fps 15fps 5fps 1fps	30fps 15fps 5fps 1fps
	System frequency 25Hz	—	—	25fps 12.5fps 5fps	—	—	—	25fps 12.5fps 5fps 1fps	25fps 12.5fps 5fps 1fps	25fps 12.5fps 5fps 1fps
	System frequency 24/23.98Hz	—	—	24fps	—	—	—	24fps 12fps 4fps 1fps	24fps 12fps 4fps 1fps	24fps 12fps 4fps 1fps

- You cannot make settings above the resolution and frame rate set by the system format.

- When “Streaming mode” is set to “MPEG2-TS over UDP”

Settings		H.265(1)	H.265(2)	H.264(1)	H.264(2)	H.264(3)	H.264(4)	JPEG(1)	JPEG(2)	JPEG(3)
Resolution		—	—	1920x1080 1280x720	—	—	—	1920x1080 1280x720 640x360 320x180	640x360 320x180	640x360 320x180
Frame rate	System frequency 59.94Hz	—	—	60fps 30fps 15fps 5fps	—	—	—	30fps 15fps 5fps 1fps	30fps 15fps 5fps 1fps	30fps 15fps 5fps 1fps
	System frequency 50Hz	—	—	50fps 25fps 12.5fps 5fps	—	—	—	25fps 12.5fps 5fps 1fps	25fps 12.5fps 5fps 1fps	25fps 12.5fps 5fps 1fps
	System frequency 29.97Hz	—	—	30fps 15fps 5fps	—	—	—	30fps 15fps 5fps 1fps	30fps 15fps 5fps 1fps	30fps 15fps 5fps 1fps
	System frequency 25Hz	—	—	25fps 12.5fps 5fps	—	—	—	25fps 12.5fps 5fps 1fps	25fps 12.5fps 5fps 1fps	25fps 12.5fps 5fps 1fps
	System frequency 24/23.98Hz	—	—	24fps	—	—	—	24fps 12fps 4fps 1fps	24fps 12fps 4fps 1fps	24fps 12fps 4fps 1fps

- You cannot make settings above the resolution and frame rate set by the system format.

Parts and their functions (continued)

- When “Streaming mode” is set to “NDI|HX V2”

Settings		NDI HX	JPEG(1)
Resolution		1920×1080 1280×720	1280×720 640×360 320×180
Frame rate	System frequency 59.94Hz	60fps 30fps 15fps 5fps	30fps 15fps 5fps 1fps
	System frequency 50Hz	50fps 25fps 12.5fps 5fps	25fps 12.5fps 5fps 1fps
	System frequency 29.97Hz	30fps 15fps 5fps	30fps 15fps 5fps 1fps
	System frequency 25Hz	25fps 12.5fps 5fps	25fps 12.5fps 5fps 1fps

- It is not possible to select NDI|HX V2 mode when the system frequency is 24/23.98Hz.
- You cannot make settings above the resolution and frame rate set by the system format.

- When “Streaming mode” is set to “High bandwidth NDI”

Settings		H.265(1)	H.265(2)	H.264(1)	H.264(2)	H.264(3)	H.264(4)	JPEG(1)	JPEG(2)	JPEG(3)
Resolution		—	—	—	—	—	—	1920×1080 1280×720 640×360 320×180	—	—
Frame rate	System frequency 59.94Hz	—	—	—	—	—	—	30fps 15fps 5fps 1fps	—	—
	System frequency 50Hz	—	—	—	—	—	—	25fps 12.5fps 5fps 1fps	—	—
	System frequency 29.97Hz	—	—	—	—	—	—	30fps 15fps 5fps 1fps	—	—
	System frequency 25Hz	—	—	—	—	—	—	25fps 12.5fps 5fps 1fps	—	—
	System frequency 24/23.98Hz	—	—	—	—	—	—	24fps 12fps 4fps 1fps	—	—

- You cannot make settings above the resolution and frame rate set by the system format.

Wireless remote control: AW-RM50AG (optional accessory)

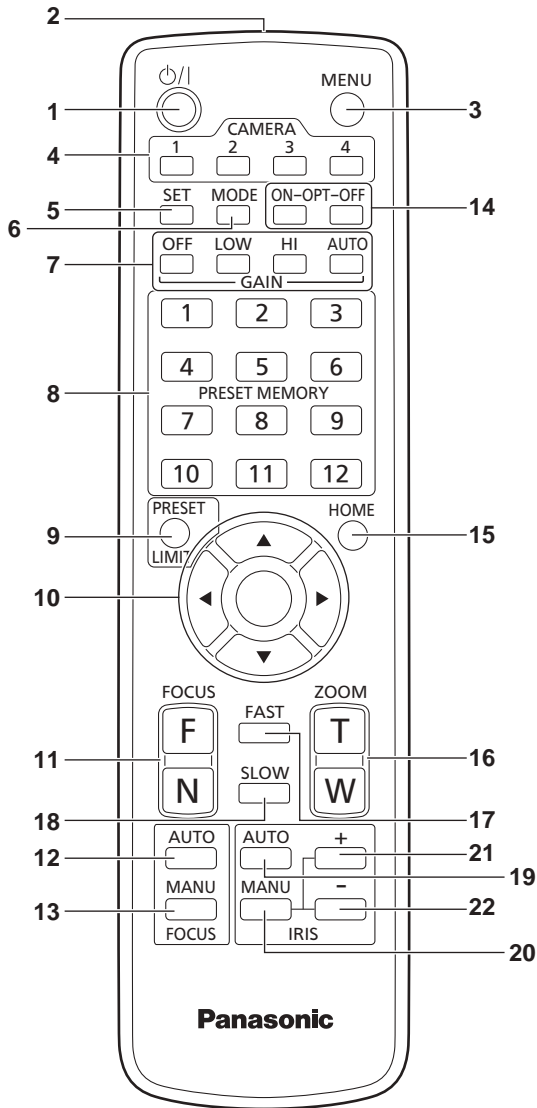

1. ON/STANDBY button <⏻/⏻>

Each time this is pressed for 2 seconds, operation switches between turning on the unit's power and establishing the standby status.

2. Signal transmission window

3. MENU button <MENU>

Each time this is pressed for 2 seconds, operation switches between displaying the unit's camera menu and exiting the camera menu. When it is pressed quickly (for less than 2 seconds) while a camera menu is displayed, the setting change is canceled. Furthermore, the pan and tilt movement range limits (limiters) are set and released by operating the <MENU> button, <PRESET/LIMIT> button and the pan/tilt buttons (<▲> <▼> <◀> <▶>). For details, refer to "Setting/releasing the limiters" (→ page 152).

4. CAMERA buttons <1> to <4>

Selects a camera to be operated. Once a button has been selected, the unit corresponding to the selected button can be operated.

5. SET button <SET>

If this button is held down for 2 seconds when the [AWB A] memory or [AWB B] memory has been selected for the white balance adjustment, the black balance is adjusted automatically and registered in the memory selected. When this button is pressed for under 2 seconds, only the white balance is adjusted automatically.

6. MODE button <MODE>

This is used to select the video signals which are output from the unit. Each time it is pressed, the signals are switched between the color bar signals and camera video signals.

<NOTE>

- When [Audio] is set to [On] and the color bar is displayed, a test sound (1 kHz) is output. Be cautious of the volume on external devices.

7. GAIN button <OFF> <LOW> <HI> <AUTO>

These are used to set the gain. The gain increase can be set in three steps using the <OFF>, <LOW> and <HI> buttons. <LOW> is set to 9 dB, and <HI> is set to 18 dB. When the <AUTO> button is pressed, the AGC function is activated, and the gain is adjusted automatically depending on the light quantity. The maximum gain of the AGC function can be set using the camera menu.

8. PRESET MEMORY buttons <1> to <12>

These are used to call the information on the unit's directions and other settings, which have been registered in the unit's preset memories No.1 to No.12, and reproduce those settings. Settings in preset memories No.13 and above cannot be called from the wireless remote control.

9. PRESET/LIMIT button <PRESET/LIMIT>

This is used to register the settings in the preset memories or set or release the limiters. When a PRESET MEMORY button is pressed while the <PRESET/LIMIT> button is held down, the information on the unit's current direction and other settings is registered in the call button. PRESET MEMORY buttons <1> to <12> correspond to the unit's No.1 to No.12 preset memories. Furthermore, the pan and tilt movement range limits (limiters) are set and released by operating the <PRESET/LIMIT> button, <MENU> button and the pan/tilt buttons (<▲> <▼> <◀> <▶>). For details, refer to "Setting/releasing the limiters" (→ page 152).

10. Pan-tilt buttons and menu operation buttons

<▲> <▼> <◀> <▶> <○>

- 1) These are used to change the unit's direction. The unit is tilted in the up/down direction using the <▲> and <▼> buttons and panned in the left/right direction using the <◀> and <▶> buttons. The <○> button does not work during tilting and panning. When the <▲> or <▼> and <◀> or <▶> buttons are pressed at the same time, the unit moves diagonally.
- 2) The buttons are used for menu operations when the unit displays the camera menus. Use the <▲>, <▼> (<◀>, <▶>) buttons to select the menu items. When a selected item has a sub-menu, the sub-menu will be displayed by pressing the <○> button. When the cursor is aligned with a particular item and the <○> button is pressed on the setting menu at the bottom hierarchical level, the setting of the selected item blinks. When the <○> button is pressed after the setting has been changed using the <▲> and <▼> (<◀> and <▶>) buttons, the setting stops blinking, and the new setting is entered. A setting for a regular menu item is reflected immediately if it is changed while it is still flashing. If the <MENU> button is pressed quickly (for less than 2 seconds) while the setting is in the blinking status, the change will be canceled, and the setting selected prior to the change will be restored.

<NOTE>

- To prevent malfunctioning, there are a number of menu items ([Scene], [Format] and [Frequency]) whose setting is not reflected immediately even if it is changed while it is still flashing. It is reflected only after the <○> button has been pressed, causing the setting to stop flashing and the new setting to be entered.
- A confirmation screen appears before the settings of some menu items are to be entered.

Parts and their functions (continued)

11.FOCUS button <F> <N>

These are used to adjust the lens focus manually when the manual setting is established for the lens focus.

The focus is adjusted in the far using the <F> button and in the near using the <N> button.

12.FOCUS AUTO button <FOCUS AUTO>

This is used when automatically adjusting the lens focus.

13.FOCUS MANU button <FOCUS MANU>

This is used when manually adjusting the lens focus.

The FOCUS buttons (<F> and <N>) are used when performing the actual adjustment.

14.OPT button <ON> <OFF>

Turn night mode on/off.

<NOTE>

- In night mode, video output will be in black and white. In addition, the iris will be forcibly opened.
- White balance adjustment is not possible in night mode.
- ND filter switching is not possible in night mode.

15.HOME button <HOME>

When this is pressed for 2 seconds, the unit's direction (panning or tilting) returns to the reference position.

16.ZOOM button <T> <W>

These are used to adjust the lens zoom.

The zoom is adjusted in the wide-angle using the <W> button and in the telephoto using the <T> button.

17.FAST button <FAST>

This is used to change the movement speed at which the panning, tilting, zooming and focusing operations are performed to the high speed.

When the button is tapped, the movement speed can be set to the normal high-speed operation. When the button is held down, it can be set to an even faster high-speed operation. Tap the button to return the movement speed to the normal high-speed operation.

<NOTE>

- The operating speed for panning and tilting when the preset memory settings have been called can be changed using the "Preset Speed" item of the camera menu.

18.SLOW button <SLOW>

This is used to change the movement speed at which the panning, tilting, zooming and focusing operations are performed to the low speed.

When the button is tapped, the movement speed can be set to the normal low-speed operation. When the button is held down, it can be set to an even slower low-speed operation. Tap the button to return the movement speed to the normal low-speed operation.

19.IRIS AUTO button <IRIS AUTO>

This establishes the setting for adjusting the lens iris automatically in line with the light quantity.

20.IRIS MANU button <IRIS MANU>

This establishes the setting for adjusting the lens iris manually.

The <IRIS +> and <IRIS -> buttons are used when performing the actual adjustment.

21.IRIS + button <IRIS +>

This is used to adjust the lens iris in the opening direction.

22.IRIS - button <IRIS ->

This is used to adjust the lens iris in the closing direction.

Setting the remote control IDs

The wireless remote control (optional accessory) is capable of operating up to four units.

IDs are used to set which units are selected when the CAMERA <1>, <2>, <3> and <4> buttons on the wireless remote control have been pressed.

- When operating a multiple number of these units using wireless remote controls, set a different remote control ID for each control.
- When using one unit, set the remote control ID to "CAM1" unless the setting needs to be changed.

Setting procedure

Operate the IR ID switches on the unit's rear panel, and select "CAM1", "CAM2", "CAM3" or "CAM4" as the remote control ID. (→ page 18)

The IR ID switch settings "CAM1" to "CAM4" correspond to the CAMERA <1> to <4> buttons on the wireless remote control. (The factory setting is "CAM1".)

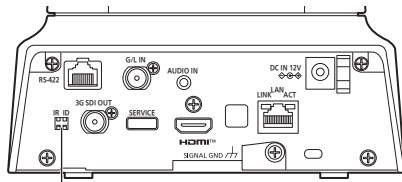

IR ID switches

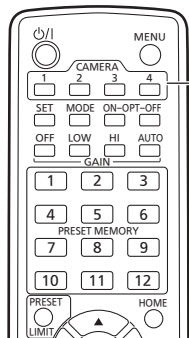

CAMERA <1> to <4> buttons

Setting the installation method ("Desktop" or "Hanging") from the OSD menu

Set "Desktop" or "Hanging" in [Install Position] on the [Pan/Tilt] screen from the OSD menu of this unit.

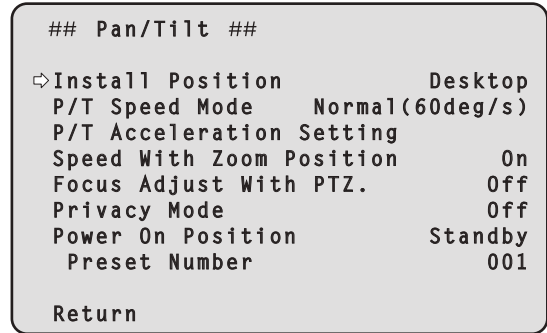

Install Position [Desktop, Hanging]

[Desktop] or [Hanging] is selected here as the method used to install the unit.

Desktop	Stand-alone installation
Hanging	Suspended installation

<NOTE>

- When [Hanging] has been selected, the top, bottom, left and right of the images will be reversed, and up/down/left/right control for panning and tilting will also be reversed.

Network settings

Using Easy IP Setup Software to make settings for the unit

The settings related to the unit's network can be established using the Easy IP Setup Software.

You can obtain Easy IP Setup Software (EasyIPSetup.exe) by downloading it from the following website.

<https://pro-av.panasonic.net/>

To establish the settings for a multiple number of units, the settings must be selected for each camera involved.

If the settings cannot be established using the Easy IP Setup Software, select the settings separately for the unit and personal computer on the Network setup screen [Network] of the setting menu. (→ page 126)

<NOTE>

- If, after the network settings have been established, another device in the same network has the same IP address, the network operations will not be performed properly.
Set the IP address in such a way that it does not duplicate an existing IP address.
- Do not establish network settings from a multiple number of Easy IP Setup Software programs at the same time for a single camera. Similarly, do not perform the "Auto IP setting" operation of the remote camera controller AW-RP150 or AW-RP60 at the same time. The IP address settings may no longer be recognized as a result.
- To enhance the security of the Easy IP Setup Software, it will not be possible to make network settings for the target camera once about 20 minutes or more have elapsed after turning the power of the camera on. (When the [Easy IP Setup accommodate period] setting is [20min] → page 128)
- The Easy IP Setup Software cannot be used from a different subnet via a router.
- Use Easy IP Setup Software ver. 4.25R00 or newer.

1. Start the Easy IP Setup Software.

2. Click the [Search] button.



3. Click the MAC address/IPv4 address of the camera to be set, and click the [Network Settings] button.

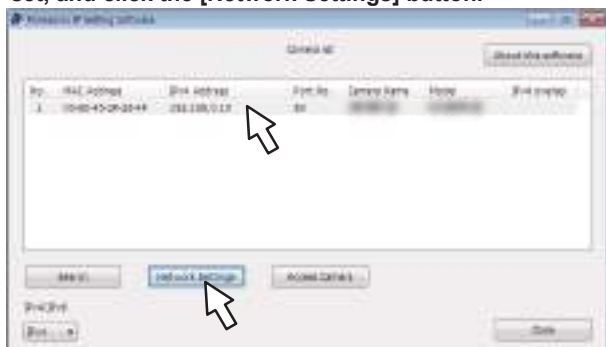

<NOTE>

- When a DHCP server is being used, the IP address allocated to the unit can be checked by clicking the [Search] button of the Easy IP Setup Software.
- If the same IP address is used for any additional cameras, the numbers of the additional cameras will be displayed in the [IPv4 overlap] column of the cameras concerned.
- When the [Access Camera] button is clicked, the Live screen of the selected camera is displayed.
- This unit supports an IPv4/IPv6 switching function.

4. Input the network items, and click the [Save] button.

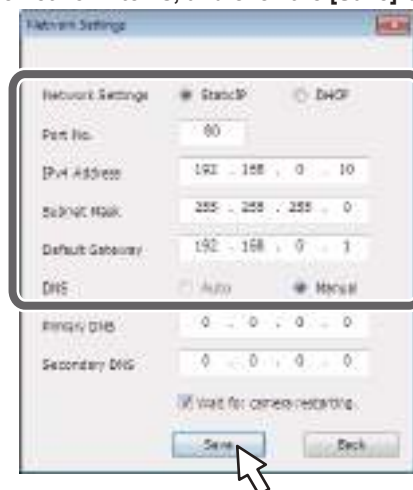

<NOTE>

- When a DHCP server is being used, [DNS] of the Easy IP Setup Software can be set to [Auto].
- After the [Save] button is clicked, it takes about 1 minute for the settings in the unit to be completed. If the AC adaptor or LAN cable is disconnected before the settings are completed, the settings will be canceled. In this case, repeat the steps to establish the settings.
- When a firewall (including software) has been introduced, enable access to all the UDP ports.

Using EasyIP Setup Tool Plus to make settings for the unit

You can use EasyIP Setup Tool Plus to make network related settings for this unit, display the camera images, and update the firmware.

The app determines PTZ cameras for which updates are available and does the necessary operations from downloading the firmware to updating the version.

EasyIP Setup Tool Plus can be obtained by downloading from the following website.

<https://pro-av.panasonic.net/>

Refer to the Help page for EasyIP Setup Tool Plus for details.

Setting the initial account

1. Set the initial account.

In the initial state, the initial account setting screen is displayed when the web screen is displayed.

Set a user name and password. (→ page 83)



<NOTE>

- Do not set character strings that can be easily guessed by third parties.
- Change the password at regular intervals.
- The password must use at least 3 of the following 4 character types and be 8 characters or longer.
 - Alphabet upper cases
 - Alphabet lower cases
 - Numerals
 - Symbols (!#\$%&'()*+,-./?@[]^_`~)
- When a password is set that does not adhere to the above policy, take responsibility for use of the device with due consideration for the security risks in the installation environment, etc.
- A warning is displayed if the set password goes against the recommended setting policy. When changing the password, click the [Back] button and set the password again.

When continuing with the setting with full understanding of the security risks, click [Continue] to complete the setting.
- If you forget the account information that was set, use the switches for initialization of service switches to reset the user information used for connecting to the network. (→ page 18)

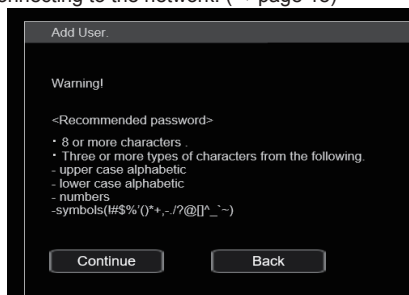

2. Completing registration of the initial account

After completing registration of the initial account, the following registration completed screen is displayed.

The live screen [Live] is automatically displayed after about 10 seconds elapse after the completed screen is displayed.

If the live screen [Live] is not displayed after 10 seconds elapse, manually move to the live screen [Live] by clicking the "please click here" link.

This completes the process of registering the initial account.

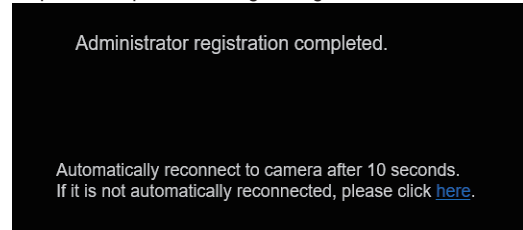

<NOTE>

- Network connection with AW-RP150 or AW-RP60 requires setup of an initial account.

When an initial account is not set up, AW-RP150 or AW-RP60 can detect but cannot control this unit.

Installing the plug-in viewer software

To view IP images from the unit on Windows Internet Explorer 11, the "Network Camera View 4S" plug-in viewer software (ActiveX®) must be installed.

The plug-in viewer software can be installed directly from the unit.



<NOTE>

- [Automatic installation of viewer software] is set to [On] at the time of purchase, allowing you to install directly from the unit. If a message appears in the web browser's information bar, see page 161.
- When you display the Live screen [Live] on the personal computer for the first time, the installation screen for the plug-in viewer software (ActiveX) appears. Follow the instructions on the screen to perform installation. (only when using Windows Internet Explorer 11)
- If the plug-in viewer software (ActiveX) installation screen continues to appear when switching screens, even after it is installed, restart the personal computer.
- A license is required for the plug-in viewer software for each personal computer on which it is installed. You can view the number of times the plug-in viewer software was automatically installed in the [Product info.] of the Maintenance screen [Maintenance] (→ page 144). For details on licenses, consult your local dealer.
- To uninstall the plug-in viewer software, select [Control Panel] - [Programs] - [Uninstall a program] in Windows, and remove "Network Camera View 4S".

Basic shooting operations

1. Set the subject brightness to the appropriate level.

2. Turn on the power of all the units and devices in the system.

3. Select the unit to be operated.

Even when using only one unit, it must still be selected from the wireless remote control or controller.

4. Select the shooting mode.

One of four shooting modes (Full Auto, Scene1, Scene2 or Scene3) — whichever one will best suit the shooting conditions — can be selected.

The shooting modes are set by the user.

For details of the factory settings, refer to pages 76 to 82.

Select the mode that satisfies the shooting conditions and suits your preferences.

When continuing to shoot in the same circumstances, there is no need to select another mode.

5. Start shooting.

(After shooting, turn off the power of all the units and devices in the system.)

<NOTE>

- Some of the initial settings are auto settings and cannot be operated manually. To operate them manually, switch from the auto settings to the manual settings as required.

If the settings have already been changed and the original settings are to be restored, refer to the “What to do when encountering problems in the basic shooting operations” (→ page 36) and “Camera screen” (→ page 47) in “Camera menu items”.

How to turn the power on and off

Turning the power on

When performing operations from a wireless remote control

1. Set all the power switches of the units and devices connected in the system to ON.

- This unit does not have a power switch.
When power is supplied to it, the status display lamp will light orange, and the unit is set to the Standby mode.

<NOTE>

- Under factory default conditions, the unit will be in Standby mode when power is supplied for the first time. (Status display lamp: Lit orange)
- When the power supply is cut off while the unit is in Standby mode, the unit will be in Standby mode the next time power is supplied. (Status display lamp: Lit orange)
- When the power supply is cut off while the unit is in Power ON mode, the unit will be in Power ON mode the next time power is supplied. (Status display lamp: Lit green)

2. Press one of the CAMERA <1> to <4> buttons on the wireless remote control to select the unit.

3. Press the <⏻/|> button on the wireless remote control for about 2 seconds.

The Power ON mode is established, images are output, and control can be exercised.

- The unit's status display lamp now lights up green.

<NOTE>

- It takes maximum 30 seconds per unit for the initial settings operation to be completed. During this period, the unit cannot be operated.
(Status display lamp: Lit orange)

4. If a multiple number of units are going to be used, repeat steps 2 and 3 as required.

The unit's status display lamp blinks green when a signal matched by the remote control ID has been received, and it blinks orange when a signal that is not matched by the remote control ID has been received.

<NOTE>

- When operation is transferred to the Standby mode:
The current zoom, focus and iris positions are stored in the memory (Power ON preset).
- When operation is transferred to the Power ON mode:
The zoom, focus and iris are adjusted to the positions which were stored in the memory (Power ON preset) when operation was transferred to the Standby mode.

When performing operations from a controller

When using an AW-RP150 or AW-RP60

For details, refer to the operating instructions for the controller.

When using a commercially available controller

For details, refer to the operating instructions for the controller.

Turning the power off

When performing operations from a wireless remote control

1. Press one of the CAMERA <1> to <4> buttons on the wireless remote control to select the unit.

2. Press the <⏻/|> button on the wireless remote control for about 2 seconds.

The unit enters Standby mode.

- The unit's status display lamp now lights up orange.

3. If a multiple number of units are going to be used, repeat steps 1 and 2 as required.

4. Set all the power switches of the units and devices connected in the system to OFF.

- This unit does not have a power switch.

<NOTE>

- When operation is transferred to the Standby mode:
The current zoom, focus and iris positions are stored in the memory (Power ON preset).
- When operation is transferred to the Power ON mode:
The zoom, focus and iris are adjusted to the positions which were stored in the memory (Power ON preset) when operation was transferred to the Standby mode.

When performing operations from a controller

When using an AW-RP150 or AW-RP60

For details, refer to the operating instructions for the controller.

When using a commercially available controller

For details, refer to the operating instructions for the controller.

Selecting the units

Select the unit (or units) to be operated from the wireless remote control or controller.

Even when using only one unit, it must still be selected.

When performing operations from a wireless remote control

Up to four units can be operated using one wireless remote control.

To select the unit using the wireless remote control, the IR ID switches on the unit's back panel must be set.

For details of the IR ID switch settings, refer to page 18 and page 26.

1. Press the CAMERA <1>, <2>, <3>, or <4> button.

The unit's status display lamp blinks green when a signal matched by the remote control ID has been received, and it blinks orange when a signal that is not matched by the remote control ID has been received.

When performing operations from a controller

A maximum of five units can be operated by one controller when using serial control.

When using an AW-RP150 or AW-RP60

For details, refer to the operating instructions for the controller.

- Network connection with AW-RP150 or AW-RP60 requires setup of an initial account. (→ page 28)

When an initial account is not set up, AW-RP150 or AW-RP60 can detect but cannot control this unit.

- When operating the camera on a network with a controller, such as the AW-RP150 or AW-RP60, and [Serial] or [IP] of [Tracking Data Output] is set to [On], the tracking data output may be delayed or the value may not be updated. (→ page 59)

Selecting the shooting modes (scene files)

Types of shooting modes

One of four shooting modes (Full Auto, Scene1, Scene2 or Scene3) — whichever one will best suit the shooting conditions — can be selected. Select the mode (Scene) that satisfies the shooting conditions and suits your preferences.

Brightness, Picture, and Matrix settings are also saved for each shooting mode, and you can change the setting values for each of these with menu operations.

For details of the factory settings, refer to pages 76 to 82.

[Full Auto]

The exposure settings such as shutter speed, gain, and aperture plus a few image quality settings are automatically adjusted.

[Scene1]

The settings of your preferences can be established in line with the shooting scene, lighting and other conditions.

The settings according to the factory settings are suited to shooting in normal usage environments including bright scenes.

[Scene2]

The settings of your preferences can be established in line with the shooting scene, lighting and other conditions.

The settings according to the factory settings are suited to shooting in low-light environments.

[Scene3]

The settings of your preferences can be established in line with the shooting scene, lighting and other conditions.

The settings according to the factory settings are for manual setting of shutter speed, gain, aperture, etc.

<NOTE>

- The results of the white balance and other adjustments are stored in the memory separately by shooting mode. Be absolutely sure to select the shooting mode before making any adjustments.
- Some of the initial settings are auto settings and cannot be operated manually. To operate them manually, switch from the auto settings to the manual settings as required.
- When switching between shooting modes (Full Auto, Scene1, Scene2 or Scene3), and [Serial] or [IP] of [Tracking Data Output] is set to [On], the tracking data output may be delayed or the value may not be updated. (→ page 59)

How to select the shooting mode

When performing operations from a wireless remote control

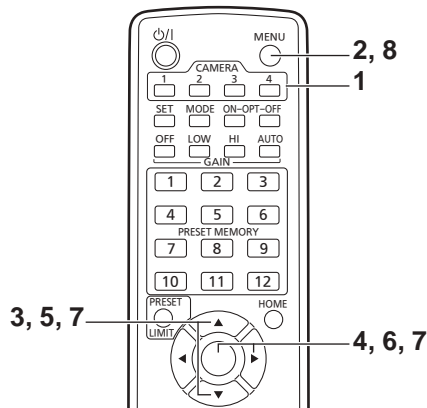

1. Press the CAMERA <1>, <2>, <3> or <4> button to select the unit.

2. Press and hold the <MENU> button for about 2 seconds. The Top Menu is displayed.

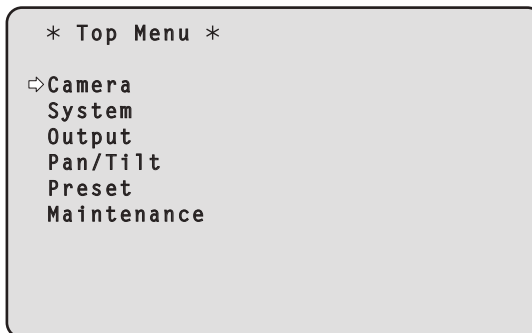

3. Press the <▲> or <▼> button to bring the cursor to [Camera].

4. Press the <○> button.

The [Camera] menu is displayed on the monitor.

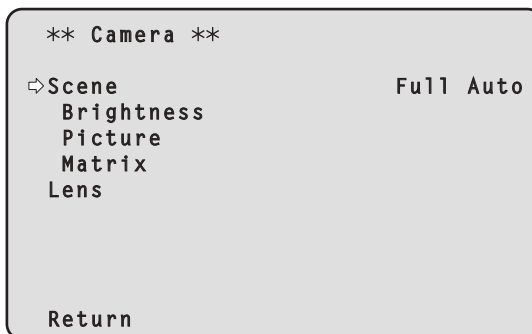

5. Press the <▲> or <▼> button to bring the cursor to [Scene].

Selecting the shooting modes (scene files) (continued)

6. Press the <O> button.

The shooting mode blinks.

7. Press the <▲> or <▼> button to select the shooting mode (Full Auto, Scene1, Scene2 or Scene3) to be used, and press the <O> button to enter the selection.

8. Press and hold the <MENU> button for about 2 seconds.

The camera menu display is exited.

When performing operations from a controller

When using an AW-RP150 or AW-RP60

For details, refer to the operating instructions for the controller.

Shooting

When performing operations from a wireless remote control

■ Changing the camera's direction

Moving the camera toward the left or right (panning):

Press the <◀> or <▶> button.

Moving the camera up or down (tilting):

Press the <▲> or <▼> button.

Moving the camera diagonally:

Press the <▲> or <▼> button and <◀> or <▶> button at the same time.

Returning the camera to the reference position:

Press the <HOME> button for about 2 seconds.

■ Using the zoom function

Zooming in (the subject becomes magnified in size):

Press the <T> button of <ZOOM>.

Zooming out (the subject becomes reduced in size):

Press the <W> button of <ZOOM>.

■ Switching the panning/tilting and lens operation speed

Changing the direction or zoom at high speed:

Press the <FAST> button.

When this button is held down, the speed can be set to an even higher speed.

When it is tapped, the normal speed (high speed) is restored.

Changing the direction or zoom at low speed:

Press the <SLOW> button.

When this button is held down, the speed can be set to an even lower speed.

When it is tapped, the normal speed (low speed) is restored.

The speeds at which the pan, tilt, zoom, focus and iris are controlled are now switched.

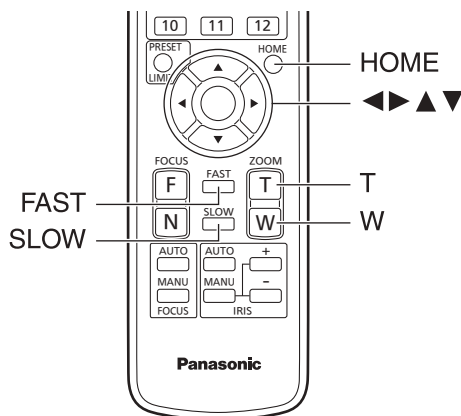

When performing operations from a controller

■ Changing the camera's direction

Moving the camera toward the left or right (panning):

Tilt the <PAN/TILT> lever toward L or R.

Moving the camera up or down (tilting):

Tilt the <PAN/TILT> lever toward UP or DOWN.

Moving the camera diagonally:

Tilt the <PAN/TILT> lever diagonally.

■ Using the zoom function

Zooming in (the subject becomes magnified in size):

Tilt the <ZOOM> lever toward the TELE direction.

Zooming out (the subject becomes reduced in size):

Tilt the <ZOOM> lever toward the WIDE direction.

■ Switching the panning/tilting and lens operation speed

When using an AW-RP150 or AW-RP60

For details, refer to the operating instructions for the controller.

What to do when encountering problems in the basic shooting operations

If the trouble is not resolved by taking the action suggested below, refer to "Troubleshooting" (→ page 154).

When performing operations from a wireless remote control

The unit does not move.

- Press the CAMERA <1>, <2>, <3> or <4> button to select the unit which is to be operated.
If only one unit is being used, it is normally selected using the CAMERA <1> button.
- Check that the IR ID switches have been set correctly. (→ page 18, page 26)
- If the unit's status display lamp is off or lights up orange, it means that the unit's power is not on.
Refer to "Turning the power on" (→ page 31), and turn on the power.
- If the unit's status display lamp does not blink even when the wireless remote control is operated near the unit's wireless remote control signal light-sensing area, it means that the wireless remote control's batteries have run down.
Replace the batteries.

Multiple color bands (color bars) are displayed.

Switch to the camera image by pressing the <MODE> button.

The menu screen is displayed.

Press the <MENU> button for 2 seconds to exit the camera menu.

The lens focus is not adjusted automatically.

Press the <FOCUS AUTO> button to switch to auto focusing.

The camera picture is too light or too dark.

- Press the <IRIS AUTO> button to switch the lens iris adjustment to auto.
- Press the <AUTO> button of <GAIN> to switch the gain adjustment to auto.

Something is wrong with the coloring of the camera pictures.

Refer to "Auto tracking white adjustment (ATW)" (→ page 41), and switch to [ATW].

The camera menus are not displayed.

Restart the camera and open any of the camera menus within about a minute, the menus will be displayed in all the outputs.

Check [OSD Mix] (→ page 62) on the camera menu [Output 3/5] screen.

When performing operations from a controller

The unit does not move.

- Select the unit to be operated by following the procedure below.
When using an AW-RP150 or AW-RP60
For details, refer to the operating instructions for the controller.
- If the unit's status display lamp is off or lights up orange, it means that the unit's power is not on.
Refer to "Turning the power on" (→ page 31), and turn on the power.
- Check that the account settings for this unit have been set correctly. (→ page 84)
- Network connection with AW-RP150 or AW-RP60 requires setup of an initial account. (→ page 28)
When an initial account is not set up, AW-RP150 or AW-RP60 can detect but cannot control this unit.

Multiple color bands (color bars) are displayed.

Switch to the camera image by pressing the <BARS> button.

The lens focus is not adjusted automatically.

Press the <AUTO> button of <FOCUS> to switch to auto focusing.

The camera picture is too light or too dark.

- Press the <AUTO> button of <IRIS> to switch the lens iris adjustment to auto.
- Press the <AUTO> button of <GAIN> to switch the gain adjustment to auto.

Something is wrong with the coloring of the camera pictures.

Refer to "Auto tracking white adjustment (ATW)" (→ page 41), and switch to [ATW].

The camera menus are not displayed.

Restart the camera and open any of the camera menus within about a minute, the menus will be displayed in all the outputs.

Check [OSD Mix] (→ page 62) on the camera menu [Output 3/5] screen.

More advanced operations

Manual shooting (→ page 38)

- Manually adjusting the focus
- Manually adjusting the iris
- Manually adjusting the shutter speed
- Manually adjusting the gain

Preset memories (→ page 39)

- Up to 100 settings for the camera direction (panning and tilting), zoom, focus, iris, gain up and white balance can be registered in the preset memories, and called.
- The number of settings that can be registered and called depends on the type of wireless remote control (12 settings) or controller that is used for operation.

White balance adjustment (→ pages 40 to 41)

- This adjustment is performed to express the white accurately. Its setting also has an effect on the color tones of the entire screen.
- It must be performed when using the unit for the first time or when the unit has not been used for a prolonged period.
- Perform adjustment when the lighting conditions or brightness changes.
- Once the white balance has been attained, no further adjustment is required provided that the unit is going to be used under the same conditions.
- White balance adjustment is not possible in night mode.

Black balance adjustment (→ page 42)

- This adjustment is performed to express the black accurately. Its setting also has an effect on the color tones of the entire screen.
- It must be performed when using the unit for the first time or when the unit has not been used for a prolonged period.
- It must be performed when the ambient temperature has changed significantly and at the change of the seasons.
- Once the black balance has been attained, no further adjustment is required provided that the unit is going to be used under the same conditions.

Black level (master pedestal) adjustment (→ page 43)

- This adjustment is performed to align the black level (pedestal level) of a multiple number of cameras.

Genlock adjustment (→ page 44)

- This adjustment is performed to achieve phase alignment by applying external synchronization (genlock) when a multiple number of cameras will be used or when the unit will be used in combination with other devices.

Manual shooting

Manually adjusting the focus

The lens focus can be adjusted manually.

When performing operations from a wireless remote control

1. Press the <FOCUS MANU> button to switch the focus to manual adjustment.
2. Press the <F> or <N> button of <FOCUS> to adjust the focus.
When the <F> button is pressed, the focus moves further away (far); conversely, when the <N> button is pressed, it moves nearer (near). The speed of focusing and other adjustments can be switched to fast or slow by pressing the <FAST> or <SLOW> button, respectively.

3. If necessary, press the <FOCUS AUTO> button to return the focus to the automatic adjustment.

When performing operations from a controller

When using an AW-RP150 or AW-RP60

For details, refer to the operating instructions for the controller.

<NOTE>

- When the focus is set to manual, the subject may go out of focus during panning, tilting and zooming. Therefore, the unit comes with a function which compensates for this. (Focus Adjust With PTZ.) If the function has been set to [Off], either adjust the focus, as required, after zooming or set the focus to auto. (→ page 63, page 93, page 120)
- When switching between focus modes (Manual/Auto), and [Serial] or [IP] of [Tracking Data Output] is set to [On], the tracking data output may be delayed or the value may not be updated. (→ page 59)

Manually adjusting the iris

The lens iris can be adjusted manually.

When performing operations from a wireless remote control

1. Press the <IRIS MANU> button to switch the iris to manual adjustment.
2. Press the <IRIS +> or <IRIS -> button to adjust the iris.
Press the <IRIS +> button to adjust the lens iris in the opening direction; conversely, press the <IRIS -> button to adjust the lens iris in the closing direction.
The speed of the iris and other adjustments can be switched to fast or slow by pressing the <FAST> or <SLOW> button, respectively.
3. If necessary, press the <IRIS AUTO> button to return the iris to the automatic adjustment.

When performing operations from a controller

When using an AW-RP150 or AW-RP60

For details, refer to the operating instructions for the controller.

<NOTE>

- In the night mode, the iris is set to open as a measure to prevent video spying.
Adjust the brightness at the light source.
- When switching between iris modes (Manual/Auto), and [Serial] or [IP] of [Tracking Data Output] is set to [On], the tracking data output may be delayed or the value may not be updated. (→ page 59)

Manually adjusting the shutter speed

The shutter speed can be set using two methods. One is a method that specifies the time (where a time such as 1/250 sec. is designated), and the other is a method that specifies the frequency (where synchro scan, 60.2 Hz, etc. is designated).

When shooting a TV screen or personal computer's monitor screen, the horizontal noise generated when the screen is shot can be minimized by adjusting the frequency to the screen frequency using synchro scan.

When performing operations from a wireless remote control

Perform the adjustments on the Camera menu.

For details, refer to the [Shutter Mode] (→ page 48) and [Step/Synchro] (→ page 48).

When performing operations from a controller

When using an AW-RP150 or AW-RP60

For details, refer to the operating instructions for the controller.

Manually adjusting the gain

There are two ways to adjust the gain. One way involves using the buttons on the wireless remote control or controller; the other way involves using the Camera menu or Web setup screen [Setup]. The gain can be adjusted more precisely using the Camera menu or Web setup screen [Setup].

For details, refer to the [Gain] (→ page 48, page 113).

<NOTE>

- When adjusting the gain, the light quantity may change suddenly (causing the image output to be subjected to a shock).

When performing operations from a wireless remote control

1. Press one of the <GAIN> buttons (<OFF>, <LOW> or <HI>).
These buttons enable the gain increase to be selected in three steps. The <LOW> button is used to select 9 dB; the <HI> button is used to select 18 dB.
2. If necessary, press the <AUTO> button of <GAIN> in order to return the gain to the automatic adjustment (AGC).

When performing operations from a controller

When using an AW-RP150 or AW-RP60

For details, refer to the operating instructions for the controller.

In any case, the maximum gain of the automatic adjustment (AGC) can be set by the camera menu or Web setup screen [Setup].
For details, refer to the [AGC Max Gain] (→ page 48, page 113).

Preset memories

This unit enables up to 100 settings for the camera direction (panning and tilting), zoom, focus, iris, gain and white balance to be registered in its preset memories, and called.

However, the number of settings that can be registered and called depends on the type of wireless remote control or controller that is used for operation.

- The focus and iris operating modes (manual and auto settings) are neither registered nor recalled. The current focus and iris values are registered.
- The focus and iris values can be recalled only when the manual settings are applicable.
- For the white balance, the current White Balance Mode adjustment values are registered. If a preset value is recalled when AWB A or AWB B is selected, the adjustment value selected when it was registered as a preset will be recalled. The R Gain and B Gain values return to 0 in such cases.

<NOTE>

- When there is a large difference in the environmental temperature between the time of registration and the time the setting is called, displacement of the preset position may occur.
- If displacement occurs, perform registration again.
- When a manual operation is performed for pan, tilt, zoom, focus or iris during preset recall, the preset operation for the pan, tilt, zoom, focus or iris operation concerned will be aborted.
- If another preset has been recalled during an ongoing preset recall, the preset being recalled is aborted, and operation for the preset called last is performed instead.
- When recalling the preset memory during an ongoing preset memory recall (the first preset memory recall is aborted and performing the subsequent preset memory recall), and [Serial] or [IP] of [Tracking Data Output] is set to [On], the tracking data output may be delayed or the value may not be updated. (→ page 59)

When performing operations from a wireless remote control

Twelve settings (preset No.1 to No.12) can be registered and called using the wireless remote control.

The <1> to <12> buttons correspond to the unit's preset memories No.1 to No.12.

■ Registering the settings in the preset memories

1. Display the picture to be shot on the monitor.

Operate the pan, tilt or zoom buttons to determine the camera angle. Adjust the focus, iris, gain and white balance if they need to be adjusted.

2. While holding down the <PRESET> button, press the button corresponding to the preset memory number.

- If a preset memory number with an already registered setting has been selected, the existing setting will be erased and replaced with the new one.

■ Calling the settings of the preset memories

1. Press the button in which the preset memory setting has been registered.

When performing operations from a controller

When using an AW-RP150 or AW-RP60

Up to 100 entries can be registered/recalled.

For details, refer to the operating instructions for the controller.

White balance adjustment

Adjust the ratio between the three primary colors (RGB) to reproduce white accurately. If the white balance is out of adjustment, not only will white be reproduced poorly, but the color tones of the screen as a whole will also be degraded.

- Perform adjustment when using the unit for the first time or when the unit has not been used for a prolonged period.
- Perform adjustment when the lighting conditions or brightness changes.

Either "AWB" (automatic white balance adjustment) which initiates automatic adjustment when the <AWB> button on the controller has been pressed or "ATW" (automatic tracking white balance adjustment) which constantly adjusts the white balance can be selected for adjustment purposes.

The results of the AWB adjustment can be stored in two memories, A and B, when [AWB A] or [AWB B] has been selected for the white balance.

- Once the white balance values have been adjusted, their setup procedure will be completed simply by selecting them using the camera menus or Web setup screen [Setup], or by pressing the buttons on the controller, provided that they are going to be used under the same conditions as the ones established when the values were set. There is no need to set it again.
- Once a new setting is entered, the previous setting will be erased.
- White balance adjustment is not possible in night mode.
- The white balance cannot be adjusted during preset playback.

Use the two memories to store settings corresponding to different shooting conditions.

<NOTE>

- After adjusting the white balance, and [Serial] or [IP] of [Tracking Data Output] is set to [On], the tracking data output may be delayed or the value may not be updated. (→ page 59)

Automatic adjustment (AWB: AWB A or AWB B)

When performing operations from a wireless remote control

1. Shoot a white subject (such as a white wall or handkerchief) so that it fills the screen.

- Do not shoot shiny or very bright objects.

- Steps 2 through 8 represent the procedure for selecting the [AWB A] or [AWB B] memory. They need not be taken if a selection has already been made.

2. Select [Full Auto], [Scene1], [Scene2] or [Scene3] as the shooting mode by following the procedure in "Selecting the shooting modes (scene files)" (→ page 33).

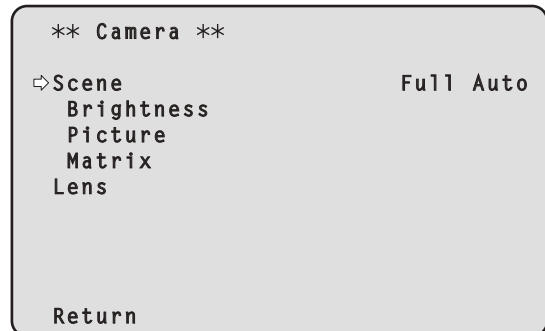

3. Press the <▲> or <▼> button to bring the cursor to [Picture].

4. Press the <○> button.

The [Picture 1/3] screen is displayed.

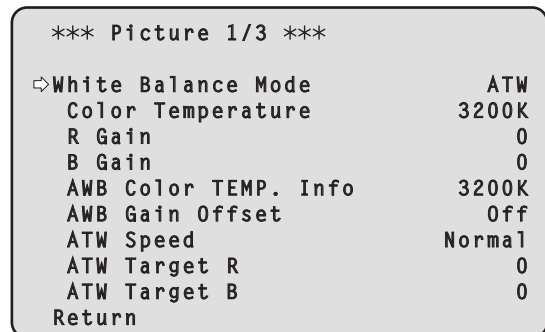

5. Press the <▲> or <▼> button to bring the cursor to [White Balance Mode].

6. Press the <○> button.

[White Balance Mode] starts blinking.

7. Press the <▲> or <▼> button to change the White Balance Mode to be used to [AWB A] or [AWB B], and press the <○> button to enter the selection.

8. Press and hold the <MENU> button for about 2 seconds.

The camera menu display is exited.

White balance adjustment (continued)

9. Press the <SET> button.

The auto white balance adjustment (AWB) is performed, and the white balance setting is entered.

- When [On] has been selected as the [OSD Status] (→ page 62) setting, the “AWB OK” message will appear at the center of the screen when the white balance adjustment is completed successfully.



<NOTE>

- Adjustment cannot be performed while the color bar is displayed. Switch to the camera image by pressing the <MODE> button.
- The white balance cannot be adjusted during preset playback.
- When the adjustment has failed, an error message such as “OUT RANGE NG”, “HIGH LIGHT NG”, “LOW LIGHT NG” or “ATW NG” is displayed.

When performing operations from a controller

When using an AW-RP150 or AW-RP60

For details, refer to the operating instructions for the controller.

<NOTE>

- White balance may not be correctly set if the lighting of the object is too weak.
- Since the unit has a built-in memory, the set white balance will remain in the memory even if power is turned off. Therefore, it is not necessary to reset the white balance if the color temperature of those objects remains unchanged. However, it must be reset if the color temperature changes, such as when you move from indoors to outside, or vice versa.

Auto tracking white adjustment (ATW)

When the white balance adjustment is set to [ATW], the white balance continues to be adjusted automatically all the time, and it is automatically corrected even when the light source or color temperature has changed to produce completely natural pictures.

This function works when [ATW] is selected instead of [AWB A] or [AWB B] by following the steps for “Automatic adjustment” in “White balance adjustment” (→ page 40).

<NOTE>

- ATW might not function properly when high brightness light (ex. fluorescent lamp) beams into a screen.
- White balance may not be accurately set if there is no white object in the scene being shot.
- The white balance may shift out of adjustment when different kinds of light sources such as sunlight and fluorescent lighting are applied.

3200K and 5600K presets

When [3200K] or [5600K] is selected for the white balance, the white balance is set using a color temperature of 3200 K (equivalent to halogen light) or 5600 K (equivalent to daylight), respectively. This function works when [3200K] or [5600K] is selected instead of [AWB A] or [AWB B] by following the steps for “Automatic adjustment” in “White balance adjustment” (→ page 40).

VAR

When [VAR] is selected for the white balance, you can select a color temperature between 2000K and 15000K.

<NOTE>

- The displayed [VAR] value does not guarantee an absolute value. Use the value as a reference.

Black balance adjustment

Adjust the zero levels of the three primary colors (RGB) to reproduce black accurately. If the black balance is out of adjustment, not only will black be reproduced poorly, but the color tones of the screen as a whole will also be degraded.

Readjustment of the black balance is not required under normal circumstances but is necessary in the following situations.

- **Perform adjustment when using the unit for the first time or when the unit has not been used for a prolonged period.**
- **Perform adjustment when the ambient temperature changes significantly, such as during changes of the season.**

<NOTE>

- After adjusting the black balance, and [Serial] or [IP] of [Tracking Data Output] is set to [On], the tracking data output may be delayed or the value may not be updated. (→ page 59)

Automatic adjustment

When performing operations from a wireless remote control

In Step 9 for “Automatic adjustment” (→ page 40) of “White balance adjustment”, when you press and hold the <SET> button for approximately 2 seconds, auto black balance adjustment (ABB) is executed and the black balance is set.

When this takes place, the lens is closed and then the adjustment is performed so the screen will temporarily turn black.

- When the black balance adjustment is completed successfully, the “ABB OK” message appears at the center of the screen.



<NOTE>

- Adjustment cannot be performed while the color bar is displayed. Switch to the camera image by pressing the <MODE> button.
- The black balance cannot be adjusted during preset playback.

When performing operations from a controller

When using an AW-RP150 or AW-RP60

For details, refer to the operating instructions for the controller.

Black level (master pedestal) adjustment

The black level can be adjusted when using a multiple number of cameras including the unit. Ask your dealer to perform this adjustment. (Use an oscilloscope or waveform monitor for the adjustment.) Adjust the black level in accordance with the units and devices used.

When performing operations from a controller

When using an AW-RP150 or AW-RP60

For details, refer to the operating instructions for the controller.

When performing operations from a wireless remote control

1. Press the <IRIS MANU> button.

Set the iris to the manual mode.

2. Press the <IRIS →> button.

The lens iris is stopped down. When [Iris Limit] is [On], it will not close below iris CLOSE.

3. Press the <▲> or <▼> button to bring the cursor to [Picture].

4. Press the <○> button.

The [Picture 2/3] screen is displayed.

*** Picture 2/3 ***	
◁ Chroma Level	0%
Chroma Phase	0
Master Pedestal	0
Detail	0n
Master Detail	0
Detail Coring	15
V Detail Level	0
Skin Detail	Off
Skin Detail Effect	16
Return	

5. Press the <▲> or <▼> button to bring the cursor to [Master Pedestal].

*** Picture 2/3 ***	
Chroma Level	0%
Chroma Phase	0
◁ Master Pedestal	0
Detail	0n
Master Detail	0
Detail Coring	15
V Detail Level	0
Skin Detail	Off
Skin Detail Effect	16
Return	

6. Press the <○> button to start the [Master Pedestal] value blinking.

7. Press the <▲> or <▼> button, change the [Master Pedestal] value, and press the <○> button to enter the selection.

Adjust the value so that it matches the black level.

8. Press and hold the <MENU> button for about 2 seconds.

The camera menu display is exited.

9. If necessary, press the <IRIS AUTO> button to adjust the iris automatically.

Genlock adjustment

The genlock adjustment is performed to achieve phase alignment by applying external synchronization (genlock) when a multiple number of cameras will be used or when the unit will be used in combination with other devices.

This unit supports BBS (Black Burst Sync) and tri-level sync external synchronization signals.

Ask your dealer to perform this adjustment.

(Use a dual-trace oscilloscope for the adjustment.)

Horizontal phase adjustment

Observe the waveforms of the external sync signal input (tri-level sync signal) and video signal output on the dual-trace oscilloscope, and use the wireless remote control or controller to bring the horizontal phase into alignment.

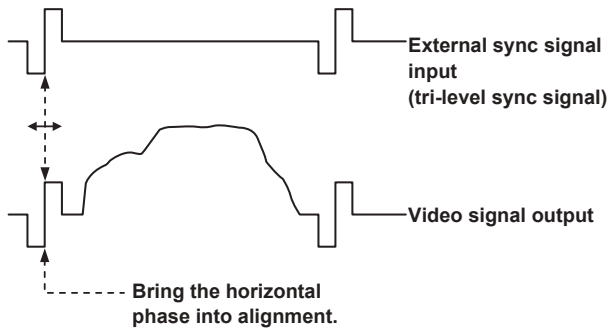

Example: When the tri-level sync phase is adjusted

When performing operations from a wireless remote control

1. Follow the operation steps in “Basic setup operations” (→ page 45) to display the Top Menu.
2. Press the <▲> or <▼> button to bring the cursor to [System].

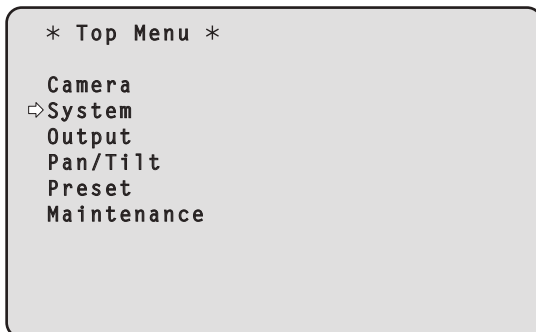

3. Press the <○> button.

The [System 1/2] screen appears.

4. Press the <▲> or <▼> button to bring the cursor to [Horizontal Phase], and press the <○> button.

The [Horizontal Phase] value starts blinking.

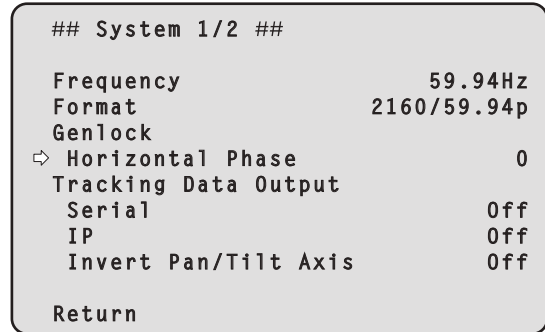

5. Press the <▲> or <▼> button to change the [Horizontal Phase] value, adjust the value so that the horizontal phase is brought into alignment, and press the <○> button.
6. Press and hold the <MENU> button for about 2 seconds. The camera menu display is exited.

Basic setup operations

Camera menus are displayed on the monitor when the unit's settings are to be selected.

The monitor is connected to the video signal output connector. The basic camera menu operations involve displaying sub-menus from the Top Menu items, and selecting settings on the sub-menus. Some sub-menus have menu items for performing more detailed settings.

The camera menu operations are conducted using the wireless remote control.

Described below are the Basic setup operations for changing the camera menu item settings using the wireless remote control.

■ Wireless remote control operations

Camera menu operation	Wireless remote control
Selecting a camera to operate	Press the CAMERA <1>, <2>, <3>, or <4> button.
Displaying the Top Menu	Press and hold the <MENU> button for about 2 seconds.
Selecting items	Press the <▲>, <▼>, <◀>, or <▶> button.
Displaying sub-menus	Press the <○> button.
Returning to the previous menu	Place the cursor on [Return], and press the <○> button.
Changing settings	Place the cursor on the item you want to change, and press the <○> button to make the setting value blink. Change the value using the <▲>, <▼>, <◀>, or <▶> button, and press the <○> button to confirm.
Canceling setting changes	Press the <MENU> button (hold for less than 2 seconds) while the setting value is blinking.
Exiting camera menu operations	Press and hold the <MENU> button for about 2 seconds.

<NOTE>

- When AW-RP150 or AW-RP60 is connected, refer to the operating instructions for the controller.

When performing the operations using the wireless remote control

- 1. Press the CAMERA <1>, <2>, <3> or <4> button to select the unit which is to be operated.**
- 2. Press and hold the <MENU> button for about 2 seconds.**
The Top Menu is displayed.
- 3. Press the <▲> or <▼> button to bring the cursor to the item to be selected.**
Each time the <▲> or <▼> button is pressed, the cursor moves. The cursor can be moved in the same way using the <◀> or <▶> buttons.
- 4. Press the <○> button.**
The sub-menu of the selected item is displayed. (Some sub-menu items have a sub-menu of their own.)
- 5. Press the <▲> or <▼> button to bring the cursor to the item to be set.**
Each time the <▲> or <▼> button is pressed, the cursor moves. The cursor can be moved in the same way using the <◀> or <▶> button. With the cursor at the [Return] position, press the <○> button to return to the previous menu.
- 6. Press the <○> button.**
The value of the item to be set starts blinking.
- 7. Press the <▲> or <▼> button to change the setting.**
The setting can be changed in the same way using the <◀> or <▶> button.
- 8. Press the <○> button.**
The value of the item to be set is entered, and it stops blinking.
- 9. After the setting has been completed, press the <MENU> button for about 2 seconds.**
The camera menu display is exited.

Camera menu items

Setting the camera menu items

Camera menus are displayed on the monitor when the unit's settings are to be selected.

The basic camera menu operations involve displaying sub-menus from the Top Menu items, and selecting settings on the sub-menus.

Some sub-menus have menu items for performing more detailed settings.

The "*" and "#" marks in the menu titles indicate the hierarchical level of the menu currently displayed.

For instance, "* Top Menu *" indicates the first hierarchical level whereas "** Camera **" and "## System ##" indicate that the second hierarchical level is now displayed.

Menu items accompanied by a "*" mark indicate data which is stored on a scene by scene basis; menu items accompanied by a "#" mark indicate data which is stored together for one camera regardless of the scenes.

For details on factory default settings, see "Camera menu item table" (→ page 76).

<NOTE>

- While the camera menu is displayed, and [Serial] or [IP] of [Tracking Data Output] is set to [On], the tracking data output may be delayed or the value may not be updated. (→ page 59)

Top Menu screen

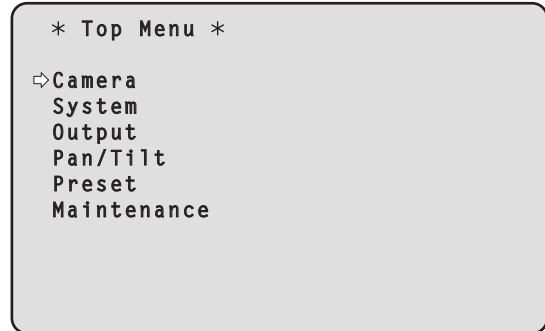

Camera

Select this to open the camera menu relating to the camera images.

System

Select this to display the System menu used to set up system format of the camera or adjust the genlock (external synchronization) phase settings.

Output

Select this to display the Output menu used for setting video/audio output for the camera, OSD output, etc.

Pan/Tilt

Select this to display the Pan/Tilt menu used for various pan/tilt operations.

Preset

Select this to display the Preset menu used for various preset playback operations.

Maintenance

Select this to display the Maintenance menu used to check the camera's firmware version or initialize its settings.

<NOTE>

- The Top Menu does not have a [Return].

Camera menu items (continued)

Camera screen

This menu is used for the camera image settings.

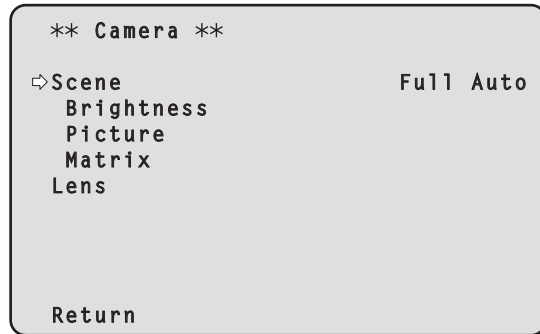

Scene [Full Auto, Scene1, Scene2, Scene3]

Selected here is the shooting mode that matches the shooting situation.

Select the mode which best suits the prevailing shooting conditions and the user's preferences.

Full Auto	Modes that allow you to adjust detailed settings manually for various shooting conditions and preferences. MENU setting items that are treated automatically will have "----" displayed and the setting cannot be changed.
Scene1	The various image quality setting items are initialized to the same values as [Full Auto], and then the settings for the items can be changed.
Scene2	The various image quality setting items are initialized to be suited to low-light environments, and then the settings for the items can be changed.
Scene3	The various image quality setting items are initialized to values that prioritize manual operations, and then the settings for the items can be changed.

Brightness

This menu item displays the Brightness screen on which to set the brightness of the images.

Picture

This menu item displays the Picture screen on which to adjust the picture quality.

Matrix

This menu item displays the Matrix screen on which to set the color matrix.

Lens

This menu item displays the Lens screen for making lens settings.

Return

Return to the previous menu level.

Brightness 1/3 screen

This menu item is selected to set the brightness of the pictures.

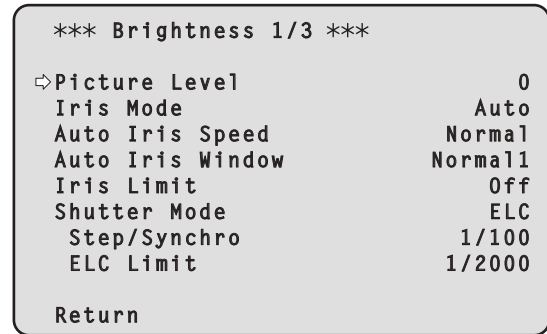

Picture Level [-50 to +50]

This menu item is selected to set the target picture level for automatic exposure compensation.

Its setting takes effect when [Auto] or [ELC] has been selected as the setting for any of the following automatic exposure compensation functions.

- When [Iris Mode] is set to [Auto]
- When [Shutter Mode] is set to [ELC]
- When [Gain] is set to [Auto]
- When [Frame Mix] is set to [Auto]

Iris Mode [Manual, Auto]

This menu item is used to select whether the iris is to be adjusted automatically or manually.

Manual	The iris is adjusted manually.
Auto	Auto exposure compensation is performed so that the target level which was set using [Picture Level] is reached.

<NOTE>

- When [Scene] is [Full Auto], the settings for this function cannot be changed and are fixed to [Auto].

Auto Iris Speed [Slow, Normal, Fast]

Set the control speed of the auto iris function.

Slow	Control the iris at a slow speed.
Normal	Control the iris at a normal speed.
Fast	Control the iris at a fast speed.

Auto Iris Window [Normal1, Normal2, Center]

Select the detection window for the auto iris.

Normal1	Window towards the center of the screen.
Normal2	Window towards the bottom of the screen.
Center	Spotted window in the center of the screen.

Iris Limit [Off, On]

When [Iris Mode] is [Manual], set the function for limiting the iris from closing to Off/On.

Off	The iris will operate within the entire range from OPEN to CLOSE.
On	Set the limit so that the iris does not CLOSE.

<NOTE>

- This is enabled only when [Iris Mode] is [Manual].
- Even if this function is set to [On], the iris OPEN direction limit is not applied. However, even if this function is set to [On], when auto black balance adjustment (ABB) is executed, it is necessary to CLOSE the iris before performing adjustment.
- When [Scene] is [Full Auto], the settings for this function cannot be changed and are fixed to [Off].

Camera menu items (continued)

Shutter Mode [Off, Step, Synchro, ELC]

Select for camera shutter mode.

Off	The shutter is set to OFF.
Step	The step shutter is set (the steps can be changed).
Synchro	The synchro shutter is set (the setting can be changed continuously).
ELC	The electronic shutter is controlled and the light quantity is adjusted automatically.

<NOTE>

- When [Scene] is [Full Auto], the settings for this function cannot be changed and are fixed to [ELC].

Step/Synchro

This is used to adjust the shutter speed in the mode which was selected as the [Shutter Mode] setting.

When a higher shutter speed is selected, fast-moving subjects do not become blurred easily but the images will be darker.

The shutter speeds that can be set are listed below.

	When [Step] is selected as the [Shutter Mode]	When [Synchro] is selected as the [Shutter Mode]
59.94p/59.94i mode	1/60, 1/100, 1/120, 1/250, 1/500, 1/1000, 1/2000, 1/4000, 1/8000, 1/10000	60.0 Hz to 7200 Hz
29.97p mode	1/30, 1/60, 1/100, 1/120, 1/250, 1/500, 1/1000, 1/2000, 1/4000, 1/8000, 1/10000	30.0 Hz to 7200 Hz
23.98p/24p mode	1/24, 1/48, 1/60, 1/100, 1/120, 1/250, 1/500, 1/1000, 1/2000, 1/4000, 1/8000, 1/10000	24.0 Hz to 7200 Hz
50p/50i mode	1/60, 1/100, 1/120, 1/250, 1/500, 1/1000, 1/2000, 1/4000, 1/8000, 1/10000	50.0 Hz to 7200 Hz
25p mode	1/25, 1/50, 1/60, 1/100, 1/120, 1/250, 1/500, 1/1000, 1/2000, 1/4000, 1/8000, 1/10000	25.0 Hz to 7200 Hz

<NOTE>

- When [Shutter Mode] is set to [Off] in 29.97p, 23.98p/24p, or 25p mode, the shutter speed is set to [1/50].
- When [Scene] is [Full Auto], the settings for this function cannot be changed.

ELC Limit [1/100, 1/120, 1/250, 1/500, 1/1000, 1/2000]

Set the maximum shutter level when ELC is operating.

<NOTE>

- When [Scene] is [Full Auto], the settings for this function cannot be changed and are fixed to [1/2000].

Return

Return to the previous menu level.

Brightness 2/3 screen

*** Brightness 2/3 ***

⇨ Gain	Auto
Super Gain	Off
AGC Max Gain	24dB
Frame Mix	Auto
Auto F.Mix Max Gain	6dB
Back Light COMP.	Off
Spot Light COMP.	Off
Flicker Suppression	Off
Return	

Gain

[When [Super Gain] is [Off]: Auto, 0dB to 36dB,

When [Super Gain] is [On]: Auto, 0dB to 42dB]

The image gain is adjusted here.

In locations which are too dark, adjust the gain upward; conversely, in locations which are too bright, adjust it downward.

When [Auto] is set, the light quantity is adjusted automatically.

The noise increases when the gain is increased.

<NOTE>

- When [Scene] is [Full Auto], the settings for this function cannot be changed and are fixed to [Auto].

Super Gain [Off, On]

Set the super gain (increased sensitivity) mode.

Off	Do not set super gain mode.
On	Set super gain mode.

<NOTE>

- When [Scene] is [Full Auto], the settings for this function cannot be changed and are fixed to [Off].

AGC Max Gain [6dB, 12dB, 18dB, 24dB, 30dB, 36dB]

When [Auto] is selected as the [Gain] setting, the maximum gain-up amount can be set.

<NOTE>

- When [Scene] is [Full Auto], the settings for this function cannot be changed and are fixed to [24dB].

Frame Mix [Auto, Off, 6dB, 12dB, 18dB, 24dB]

Select for frame addition (gain-up using sensor storage) amount.

When frame addition is performed, it will appear as if the images are missing some frames.

When [Shutter Mode] is [ELC], you can set only [Auto] or [Off].

This cannot be set when [Shutter Mode] is [Step] or [Synchro].

This cannot be configured when the format is 2160/29.97p, 2160/23.98p, 2160/24p, 2160/25p, 1080/29.97p, 1080/23.98p(59.94i), 1080/23.98p, 1080/24p, 1080/29.97PsF, 1080/23.98PsF, 1080/25p or 1080/25PsF.

<NOTE>

- Under discharge tube illumination, such as fluorescent and mercury-vapor lights, the brightness may change cyclically, colors may change, and horizontal stripes may flow up and down the image.
- When [Frame Mix] is set to 6dB, 12dB, 18dB or 24dB, if you set [Shutter Mode] to [ELC], [Frame Mix] is changed to [Off].
- When [Scene] is [Full Auto], the settings for this function cannot be changed and are fixed to [Auto].

Camera menu items (continued)

Auto F.Mix Max Gain [0dB, 6dB, 12dB, 18dB]

Sets the maximum amount of frames that can be added when [Frame Mix] is running in [Auto] mode.

When frame addition is performed in [Auto] mode, it will appear as if the images are missing some frames.

Back Light COMP. [Off, On]

Turn the backlight compensation function On/Off.

The camera compensates to make the overall screen brighter to reduce the effect of the subject darkening due to backlight.

This is enabled when the following automatic exposure compensation functions are set to either [Auto] or [ELC].

- When [Iris Mode] is set to [Auto]
- When [Shutter Mode] is set to [ELC]
- When [Gain] is set to [Auto]
- When [Frame Mix] is set to [Auto]

<NOTE>

- When [Spot Light COMP.] is set to [On], [Back Light COMP.] is [Off].

Spot Light COMP. [Off, On]

Turn the spotlight compensation function On/Off.

The camera compensates to shoot bright subjects cleanly when something like a spotlight makes the center extremely bright.

This is enabled when the following automatic exposure compensation functions are set to either [Auto] or [ELC].

- When [Iris Mode] is set to [Auto]
- When [Shutter Mode] is set to [ELC]
- When [Gain] is set to [Auto]
- When [Frame Mix] is set to [Auto]

<NOTE>

- When [Back Light COMP.] is set to [On], [Spot Light COMP.] is [Off].

Flicker Suppression [Off, On]

Turn the flicker suppression function On/Off.

The light that is generated under discharge tubes (such as fluorescent lights) changes cyclically and produces a flickering effect, and this function can reduce these issues that produce horizontal stripes in colors.

Brightness 3/3 screen

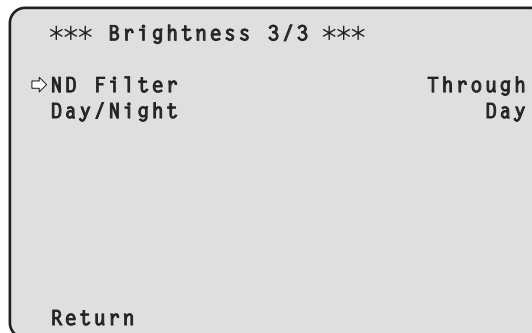

ND Filter [Through, 1/4, 1/16, 1/64, Auto]

Set the transmittance of the lens' built-in ND (neutral density) filter.

The filter switches when the setting is fixed.

Through	Do not set ND filter.
1/4	Set ND filter transmittance to 1/4.
1/16	Set ND filter transmittance to 1/16.
1/64	Set ND filter transmittance to 1/64.
Auto	The transmittance of the ND filter is automatically adjusted to one of [Through], [1/4], [1/16], or [1/64]. This can only be set when [Scene] is [Full Auto].

Day/Night [Day, Night]

Switch between standard shooting and night-vision shooting (shooting with infrared light).

Day	Standard shooting (day mode)
Night	Night-vision shooting (night mode)

<NOTE>

- In night mode, video output will be in black and white. In addition, the iris will be forcibly opened.
- White balance adjustment is not possible in night mode.
- ND filter switching is not possible in night mode.
- [Pedestal] cannot be performed properly in night mode.

Return

Return to the previous menu level.

Picture 1/3 screen

*** Picture 1/3 ***	
↪ White Balance Mode	ATW
Color Temperature	3200K
R Gain	0
B Gain	0
AWB Color TEMP. Info	3200K
AWB Gain Offset	Off
ATW Speed	Normal
ATW Target R	0
ATW Target B	0
Return	

White Balance Mode

[ATW, AWB A, AWB B, 3200K, 5600K, VAR]

Set the white balance mode.

Select the mode when the coloring is not natural because of the nature of the light source or other factors.

If the white color serving as the reference can be recognized, subjects can be shot with natural coloring.

ATW	In this mode, the white balance is compensated for automatically, even if changes occur in the light source or color temperature, by a process of continuous and automatic adjustment.
AWB A AWB B	When [AWB A] or [AWB B] is selected and the white balance is executed, the adjustment results obtained are stored in the memory selected. When [AWB A] or [AWB B] is then selected, the white balance stored in the selected memory can be recalled.
3200K	This is the white balance mode which is ideal when a 3200K halogen light is used as the light source.
5600K	This is the white balance mode which is ideal when 5600K sunlight or fluorescent lighting is used as the light source.
VAR	You can specify a color temperature between 2000K to 15000K.

Color Temperature [2000K to 15000K]

You can specify a color temperature between 2000K to 15000K. Its setting takes effect when [VAR] has been selected as the [White Balance Mode] setting.

R Gain [-200 to +200]

This enables the R gain to be adjusted.

Its setting takes effect when [AWB A], [AWB B] or [VAR] has been selected as the [White Balance Mode] setting.

B Gain [-200 to +200]

This enables the B gain to be adjusted.

Its setting takes effect when [AWB A], [AWB B] or [VAR] has been selected as the [White Balance Mode] setting.

AWB Color TEMP. Info

This displays the color temperature when [White Balance Mode] is [AWB A] or [AWB B]. This only displays the setting value. You cannot change the setting value here.

AWB Gain Offset [Off, On]

When auto white balance is performed by setting [White Balance Mode] to [AWB A] or [AWB B], set the values for Rch gain and Bch gain.

Off	Set the value of [R Gain] and [B Gain] to [0].
On	Maintain the value set in [R Gain] and [B Gain].

ATW Speed [Normal, Slow, Fast]

Set the control speed of the ATW function.

Normal	Tracks at normal speed.
Slow	Tracks at a speed slower than [Normal].
Fast	Tracks at a speed faster than [Normal].

This is only enabled when [White Balance Mode] is set to [ATW].

ATW Target R [-10 to +10]

Make fine adjustments to the Rch output when converging with the auto tracking white balance operation.

This is only enabled when [White Balance Mode] is set to [ATW].

ATW Target B [-10 to +10]

Make fine adjustments to the Bch output when converging with the auto tracking white balance operation.

This is only enabled when [White Balance Mode] is set to [ATW].

Return

Return to the previous menu level.

Picture 2/3 screen

*** Picture 2/3 ***	
⇨ Chroma Level	0%
Chroma Phase	0
Master Pedestal	0
Detail	0n
Master Detail	0
Detail Coring	15
V Detail Level	0
Skin Detail	Off
Skin Detail Effect	16
Return	

Chroma Level [Off, -99% to 99%]

Set here the color intensity (chroma level) of the images.

Chroma Phase [-31 to +31]

Make fine adjustments to the hue of the colors in the images.

Master Pedestal [-200 to +200]

This item is used to adjust the black level (adjust the pedestal). These parts become darker when a negative setting is selected and, conversely, lighter when a positive setting is selected.

Detail [Off, On]

Turn on/off the contour (sharpness of images) adjustment of images.

Master Detail [-31 to +31]

Adjust the contour correction level (master). This is only enabled when [Detail] is set to [On].

Detail Coring [0 to 60]

Set the level of the signal (including noise) which makes the detail effect not work. This is only enabled when [Detail] is set to [On].

V Detail Level [-7 to +7]

Adjust the contour correction level in the vertical direction. This is only enabled when [Detail] is set to [On].

Skin Detail [Off, On]

This function smooths skin and produces a more beautiful image. This is only enabled when [Detail] is set to [On].

Skin Detail Effect [0 to 31]

The skin of human subjects appears smoother the larger the setting value. This is only enabled when [Detail] is set to [On] and [Skin Detail] is set to [On].

Return

Return to the previous menu level.

Picture 3/3 screen

*** Picture 3/3 ***	
⇨ Gamma Mode	Normal
Gamma	0.45
DRS	Off
Knee Mode	Auto
White Clip	On
White Clip Level	109%
DNR	Low
Return	

Gamma Mode

[Normal, HD, Cinema1, Cinema2, Still Like]

Select the type of gamma curve.

Normal	Standard gamma characteristic.
HD	HD (High Definition) video gamma characteristic.
Cinema1	High contrast gamma characteristic.
Cinema2	Sedate gamma characteristic.
Still Like	Sets the gamma characteristics for a digital still camera image tone.

<NOTE>

- This is enabled only when [DRS] is [Off].
- When [Scene] is [Full Auto], the settings for this function cannot be changed and are fixed to [Normal].

Gamma [0.30 to 0.75]

Adjust the gamma correction level. Specifying smaller values results in a gentler gamma curve for the slope of low-brightness areas and sharper contrast. Specifying larger values results in an expanded gradient for dark areas and produces brighter images. The gamma curve for low-brightness areas will be steeper, and contrast will be softer.

<NOTE>

- This is enabled when [Gamma Mode] is [Normal] or [HD].
- When [Scene] is [Full Auto], the settings for this function cannot be changed and are fixed to [0.45].

DRS [Off, Low, Mid, High]

Set the DRS function which performs correction when video with high light/dark contrast is displayed. You can select from a [Low], [Mid], or [High] effect level.

<NOTE>

- This is enabled when [Gamma Mode] is [Normal] or [HD].
- When [Scene] is [Full Auto], the settings for this function cannot be changed and are fixed to [Off].

Knee Mode [Off, Auto, Low, Mid, High]

Set the operating mode for gradation compression (knee).

Off	Turn the knee function off.
Auto	Enable the knee function, and set the knee point and knee slope automatically.
Low, Mid, High	Enable the knee function, and manually set the knee point and knee slope in three steps.

<NOTE>

- When [DRS] is enabled, the knee setting is disabled.
- When [Scene] is [Full Auto], the settings for this function cannot be changed and are fixed to [Auto].

Camera menu items (continued)

White Clip [Off, On]

Turn the white clip function off/on.

White Clip Level [90% to 109%]

Set the white clip level.

This is only enabled when [White Clip] is set to [On].

<NOTE>

- When [Knee Mode] is set to [Auto] and the value of [White Clip Level] is changed, the knee value will also change.

DNR [Off, Low, High]

Set the digital noise reduction level for outputting bright, clear images without noise, even at night and low-light conditions.

When [Low] or [High] is selected, noise can be eliminated.

However, image lag may increase.

Return

Return to the previous menu level.

Matrix 1/5 screen

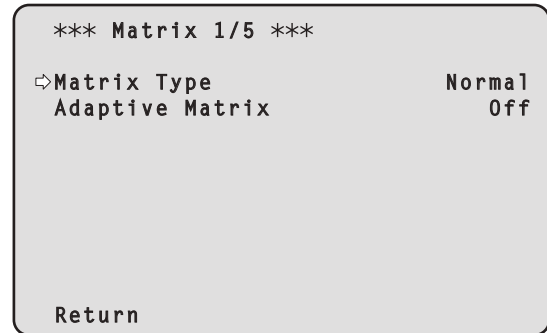

Matrix Type [Normal, Professional, User]

Select the type of color matrix.

Normal	Standard preset matrix setting.
Professional	Preset matrix setting equivalent to Panasonic broadcasting devices.
User	On the [Matrix 2/5] screen, the [Linear Matrix] value can be adjusted by the user. On the [Matrix 3/5] screen, [Matrix 4/5] screen or [Matrix 5/5] screen, the [Color Correction] value can be adjusted by the user.

<NOTE>

- With color matrix data that has been preset other than [User], the values can be referred to in the [Matrix 2/5] screen, [Matrix 3/5] screen, [Matrix 4/5] screen, and [Matrix 5/5] screen.

Adaptive Matrix [Off, On]

Set Off/On the function that suppresses the linear matrix to suit the shooting conditions.

Return

Return to the previous menu level.

Matrix 2/5 screen

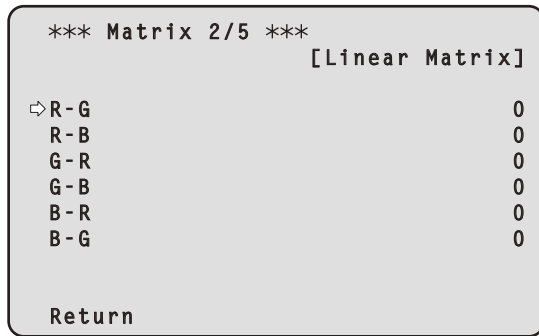

Linear Matrix

This can be set when [User] has been selected as the [Matrix Type] setting.

R-G	Adjust the color to between -63 and +63 for each axis direction.
R-B	
G-R	
G-B	
B-R	
B-G	

<NOTE>

- If the [Matrix Type] is set to other than [User], the preset settings are displayed.

Return

Return to the previous menu level.

Matrix 3/5 screen

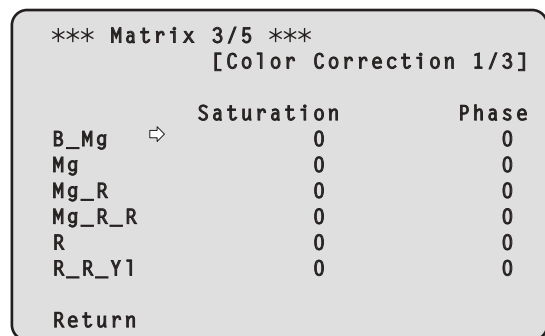

Color Correction 1/3

This can be set when [User] has been selected as the [Matrix Type] setting.

Adjust the saturation and hue.

Saturation [-63 to +63]

Adjust the saturation for each color.

Phase [-63 to +63]

Adjust the hue for each color.

B_Mg	Color between blue and magenta
Mg	Magenta
Mg_R	Color between magenta and red
Mg_R_R	Color with a 1:3 magenta to red ratio
R	Red
R_R_YI	Color with a 3:1 red to yellow ratio

<NOTE>

- If the [Matrix Type] is set to other than [User], the preset settings are displayed.

Return

Return to the previous menu level.

Matrix 4/5 screen

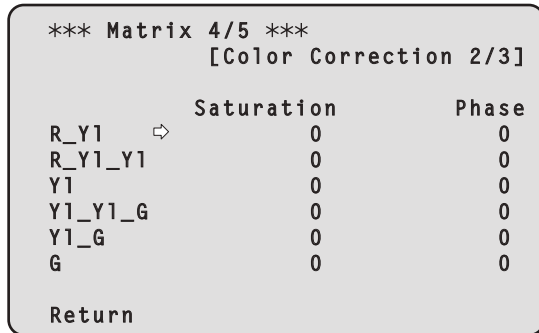

Color Correction 2/3

This can be set when [User] has been selected as the [Matrix Type] setting.

Adjust the saturation and hue.

Saturation [-63 to +63]

Adjust the saturation for each color.

Phase [-63 to +63]

Adjust the hue for each color.

R_Y1	Color between red and yellow
R_Y1_Y1	Color with a 1:3 red to yellow ratio
Y1	Yellow
Y1_Y1_G	Color with a 3:1 yellow to green ratio
Y1_G	Color between yellow and green
G	Green

<NOTE>

- If the [Matrix Type] is set to other than [User], the preset settings are displayed.

Return

Return to the previous menu level.

Matrix 5/5 screen

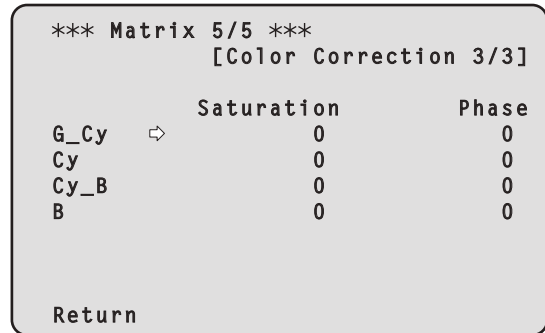

Color Correction 3/3

This can be set when [User] has been selected as the [Matrix Type] setting.

Adjust the saturation and hue.

Saturation [-63 to +63]

Adjust the saturation for each color.

Phase [-63 to +63]

Adjust the hue for each color.

G_Cy	Color between green and cyan
Cy	Cyan
Cy_B	Color between cyan and blue
B	Blue

<NOTE>

- If the [Matrix Type] is set to other than [User], the preset settings are displayed.

Return

Return to the previous menu level.

Camera menu items (continued)

Lens screen

### Lens ###	
Focus Mode	Auto
AF Sensitivity	Normal
Zoom Mode	Opt.Zoom
Max Digital Zoom	x10
Digital Extender	Off
O.I.S. Mode	Off
Return	

Focus Mode [Auto, Manual]

Select auto or manual mode for the focus adjustment function.

Auto	Always adjust focus automatically.
Manual	Adjust focus manually.

AF Sensitivity [Normal, Stable]

Select the conformability mode for auto focusing function.

Normal	Focusing is with a standard conformability.
Stable	Focusing is with a priority placed on stability.

Zoom Mode [Opt.Zoom, i.Zoom, D.Zoom]

Set the maximum magnification rate for zoom.

Opt.Zoom	Use only optical zoom. Optical zoom up to 24x is possible.
i.Zoom	Enable the i.Zoom function. When this function is enabled, digital zoom is used while reducing image degradation. When [Format] in the [System 1/2] screen is 2160/29.97p, 2160/25p, 2160/24p, 2160/23.98p Up to 28x zoom is possible combining optical zoom and digital zoom. • When [Format] in the [System 1/2] screen is other than one of these, up to 36x zoom is possible combining optical zoom and digital zoom.
D.Zoom	Enable the digital zoom function. Higher digital zoom magnifications will result in coarser images.

Max Digital Zoom

[x2, x3, x4, x5, x6, x7, x8, x9, x10]

Set the maximum digital zoom magnification.

This is only enabled when [Zoom Mode] is set to [D.Zoom].

<NOTE>

- Higher digital zoom magnifications will result in coarser images.

Digital Extender [Off, x1.4, x2.0]

Make settings for the digital extender function.

Off	Turn the digital extender function off.
x1.4	The digital zoom will be fixed at 1.4x.
x2.0	The digital zoom will be fixed at 2.0x.

This is only enabled when [Zoom Mode] is set to [Opt.Zoom].

O.I.S. Mode

[Off, O.I.S.(STABLE), O.I.S.(PAN/TILT)]

Sets the mode for optical image stabilization (O.I.S.).

Off	Turns the optical image stabilization (O.I.S.) function and electronic image stabilization (EIS) function Off.
O.I.S. (STABLE)	Turns the optical image stabilization (O.I.S.) function and roll direction electronic image stabilization (EIS) function On. Use with a pan/tilt fixed shooting scene.
O.I.S. (PAN/TILT)	Turns the optical image stabilization (O.I.S.) function and roll direction electronic image stabilization (EIS) function On. Use with a scene for increasing the image stabilization effect during a shooting while performing the pan/tilt operation.

<NOTE>

- In [O.I.S.(STABLE)] mode, the optical image stabilization (O.I.S.) function's level of correction is reduced during pan/tilt operations in order to minimize the convergence resulting from image stabilization during pan/tilt operations.
- In [O.I.S.(PAN/TILT)] mode, as importance is given to heighten the image stabilization effect during pan/tilt operations, the convergence resulting from image stabilization during pan/tilt control may be a cause for concern in some scenes.
Use [O.I.S.(STABLE)] for scenes where the convergence resulting from image stabilization needs to be restrained.

Return

Return to the previous menu level.

System 1/2 screen

## System 1/2 ##	
↪ Frequency	59.94Hz
Format	2160/59.94p
Genlock	
Horizontal Phase	0
Tracking Data Output	
Serial	Off
IP	Off
Invert Pan/Tilt Axis	Off
Return	

Frequency [59.94Hz, 50Hz, 24Hz, 23.98Hz]

This item is selected to switch the frame frequency.

- For details on how to change the frequency, refer to “Changing the frequency” (→ page 58).

Format

For [59.94Hz]

2160/59.94p, 2160/29.97p, 1080/59.94p, 1080/59.94i, 1080/29.97p, 1080/29.97PsF, 1080/23.98p(59.94i)*1, 720/59.94p

For [50Hz]

2160/50p, 2160/25p, 1080/50p, 1080/50i, 1080/25p, 1080/25PsF, 720/50p

For [24Hz]

2160/24p, 1080/24p

For [23.98Hz]

2160/23.98p, 1080/23.98p, 1080/23.98PsF

*1 It denotes “1080/23.98p over 59.94i”.

<NOTE>

- Streaming stops when changing the system format.
- For details on how to change the format, refer to “Changing the format” (→ page 58).

Genlock

This item is selected to perform the phase adjustments.

Horizontal Phase [-206 to +49]

This is used to adjust the horizontal phase during genlock.

Tracking Data Output

Settings for the output of tracking data to be used in a virtual studio system or elsewhere. (→ page 59)

Serial [Off, On]

Sets the function [On] or [Off] to output the tracking data, such as Pan/Tilt/Zoom or other information from Serial Output (RS-422), synchronized with the Genlock signal. (→ page 59)

<NOTE>

- The serial connection of the remote controller (AW-RP150 or AW-RP60, etc.) cannot be made if [Serial] is already [On].
- In the following cases, the tracking data output may be delayed or the value may not be updated.
 - While viewing the OSD menu
 - While recalling the preset value during an ongoing preset recall
 - When executing AWB/ABB
 - When a red or a green tally signal input has been changed between Off and On
 - When deleting a preset memory
 - When an output image is flipped (turned upside down or left-right reversed)
 - After switching [Scene]
 - After switching [Iris Mode]
 - After switching [Super Gain]
 - After switching [White Balance Mode]
 - After switching [Gamma Mode]
 - After switching [Matrix Type]
 - After switching [Focus Mode]
 - After switching [Zoom Mode]
 - After switching [Max Digital Zoom]
 - After switching [Digital Extender]
 - After switching [Fan]
 - After switching [OSD Mix]
 - After switching [Tally]
 - After switching [Install Position]
 - After switching [Preset Speed Unit]
 - When executing [Initialize] of [Maintenance]

IP [Off, On]

Sets the UDP output function [On] or [Off] to output tracking data, such as Pan/Tilt/Zoom or other information from the IP output, synchronized with the Genlock signal. (→ page 60)

<NOTE>

- When [IP] is [On], video transmission via IP may be delayed or the video may suffer frame loss.
We recommend setting [IP] to [Off] to avoid the delay or frame loss due to the video transmission via IP.
- In the following cases, the tracking data output may be delayed or the value may not be updated.
 - When performing video transmission via IP (M-JPEG/H.264/H.265/RTMP/RTMPS/NDI/NDI|HX/SRT)
 - When opening the web screen (live screen [Live] or the web setting screen [Setup])
 - While viewing the OSD menu
 - While recalling the preset value during an ongoing preset recall
 - When executing AWB/ABB
 - When a red or a green tally signal input has been changed between Off and On
 - When deleting a preset memory
 - When an output image is flipped (turned upside down or left-right reversed)
 - After switching [Scene]
 - After switching [Iris Mode]
 - After switching [Super Gain]
 - After switching [White Balance Mode]
 - After switching [Gamma Mode]
 - After switching [Matrix Type]
 - After switching [Focus Mode]
 - After switching [Zoom Mode]
 - After switching [Max Digital Zoom]
 - After switching [Digital Extender]
 - After switching [Fan]
 - After switching [OSD Mix]
 - After switching [Tally]
 - After switching [Install Position]
 - After switching [Preset Speed Unit]
 - When executing [Initialize] of [Maintenance]

Invert Pan/Tilt Axis [Off, On]

Sets whether to invert the Pan/Tilt data for output in the tracking data.

Off	Pan/Tilt data is not inverted.
On	Pan/Tilt data is inverted for output.

Return

Return to the previous menu level.

System 2/2 screen

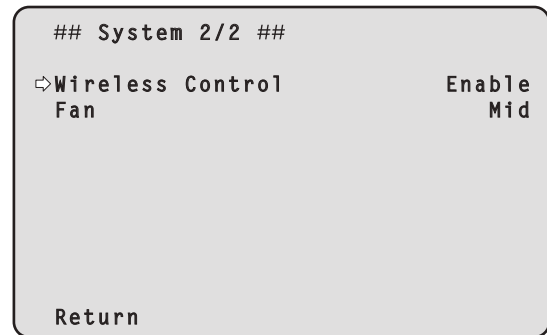

Wireless Control [Enable, Disable]

[Enable] or [Disable] is set here for operations conducted from the wireless remote control.

<NOTE>

- When the power is turned on with the wireless remote control, then operations from the wireless remote control are possible irrespective of this setting value.
- This item is not reflected immediately when the setting is changed. It is reflected when the unit is set to Standby mode, and then the power is turned ON with any external device other than the wireless remote control.
- This setting is not reflected when the power is turned ON with this item set to [Enable]. It is reflected when the unit is set to Standby mode, and then the power is turned ON with any external device other than the wireless remote control.

Fan [Auto, Low, Mid, High]

Set the operation of the cooling fan.

Auto	Enable automatic control of the cooling fan.
Low	Operate the cooling fan at low speed.
Mid	Operate the cooling fan at medium speed.
High	Operate the cooling fan at high speed.

<NOTE>

- Even if this is set to [Low], [Mid], or [High], the cooling fan may be forcibly stopped when the temperature is low.
- Even if this is set to [Low] or [Mid], the cooling fan may be forcibly operated at [High] when the temperature is high.

Return

Return to the previous menu level.

■ Changing the frequency

When the currently selected frequency is changed in the [System 1/2] screen, the pre-frequency-change confirmation screen appears.

Pre-frequency-change confirmation screen

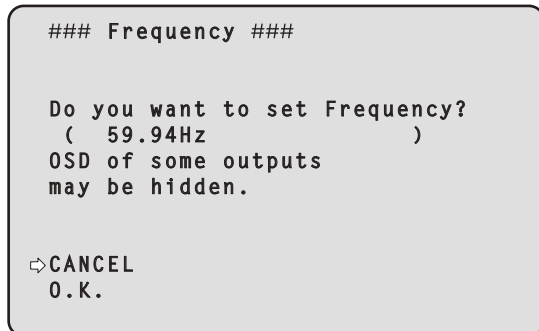

- The frequency to be set is displayed within the parentheses on the screen.
- When you move the cursor to [O.K.] on the pre-frequency-change confirmation screen and confirm, the frequency is changed.

<NOTE>

- When using a monitor that does not support 59.94Hz/50Hz/24Hz/23.98Hz frequencies, images may not be displayed after the frequency is changed. Before changing the frequency, verify that your monitor supports the frequency.
- When Frequency is changed, the unit restarts.

■ Changing the format

When the currently selected format is changed in the [System 1/2] screen, the pre-format-change confirmation screen appears.

Pre-format-change confirmation screen

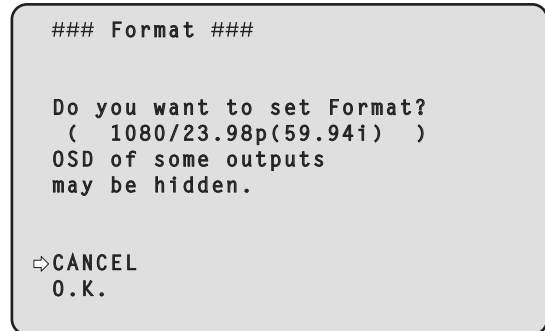

- The format to be set is displayed within the parentheses on the screen.
- When you move the cursor to [O.K.] on the pre-format-change confirmation screen and confirm, the post-format-change confirmation screen appears.

Post-format-change confirmation screen

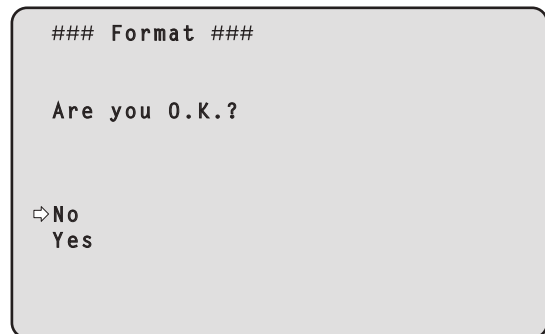

- If you move the cursor to [Yes] and confirm, the display returns to the [System 1/2] screen in the post-change format.
- If you move the cursor to [No] and confirm, the display returns to the [System 1/2] screen in the pre-change format. The same occurs if an operation is not performed within 10 seconds.
- When Format is changed, IP video transmission is stopped.
- When Format is changed, the Format for each output terminal (3G SDI OUT, HDMI) is reset to its predefined value.

■ Tracking data output

When [Serial] or [IP] of [Tracking Data Output] on the [System 1/2] screen is set to [On], outputs the tracking data for Pan/Tilt/Zoom or other information to link with a virtual studio system or elsewhere via serial (RS-422) or IP output.

● Serial (RS-422) output

- When [Serial] of [Tracking Data Output] on the [System 2/2] screen is set to [On], the tracking data for Pan/Tilt/Zoom or other information is synchronized with the Genlock signal and output via the serial output (RS-422).
- The tracking data is output in stream mode in a format conforming to the free-d protocol. The message type is Type D1 (camera position/orientation data) only.

Advanced stored data

This unit stores and outputs the following data according to the packet structure specified in Type D1 of the free-d protocol.

Camera ID

Always stores FFh.

Camera Pan Angle

Stores the Pan angle of the unit (–175° to +175°) with the format provided by the free-d protocol.

Camera Tilt Angle

Stores the Tilt angle of the unit (–30° to +210°) with the format provided by the free-d protocol.

<NOTE>

- The range of the angle is limited to between –90° and +90° in the free-d protocol. However, this unit can store greater angles than +90° (up to +210°).

Camera Roll Angle

Stores the rotation angle (0° or 180°) corresponding to the flip state (turned upside down or left-right reversed) of the unit with the format provided by the free-d protocol.

Camera X-Position

Always stores 000000h.

Camera Y-Position

Always stores 000000h.

Camera Height (Z-Position)

Always stores 000000h.

Camera Zoom

Stores the magnification of optical zoom of this unit between 000555h (WIDE) and 000FFFh (TELE).

<NOTE>

- The magnification of digital zoom is not stored.

Camera Focus

Stores the value of focus position of this unit between 000555h (NEAR) and 000FFFh (FAR).

Spare / User Defined (16bit)

Stores the value of iris position of this unit between 0555h (CLOSE) and 0FFFh (OPEN).

Checksum

Stores the checksum value provided by the free-d protocol.

<NOTE>

- The serial connection of the remote controller (AW-RP150 or AW-RP60, etc.) cannot be made if [Serial] is already [On].
- In the following cases, the tracking data output may be delayed or the value may not be updated.
 - While viewing the OSD menu
 - While recalling the preset value during an ongoing preset recall
 - When executing AWB/ABB
 - When a red or a green tally signal input has been changed between Off and On
 - When deleting a preset memory
 - When an output image is flipped (turned upside down or left-right reversed)
 - After switching [Scene]
 - After switching [Iris Mode]
 - After switching [Super Gain]
 - After switching [White Balance Mode]
 - After switching [Gamma Mode]
 - After switching [Matrix Type]
 - After switching [Focus Mode]
 - After switching [Zoom Mode]
 - After switching [Max Digital Zoom]
 - After switching [Digital Extender]
 - After switching [Fan]
 - After switching [OSD Mix]
 - After switching [Tally]
 - After switching [Install Position]
 - After switching [Preset Speed Unit]
 - When executing [Initialize] of [Maintenance]

Camera menu items (continued)

● IP output

- When [IP] of [Tracking Data Output] on the [System 2/2] screen is set to [On], the tracking data for Pan/Tilt/Zoom or other information is synchronized with the Genlock signal and outputs UDP packets via IP.
- The tracking data is output in a format conforming to the free-d protocol. The output specification (mode, command type, advanced stored data) of this unit is equivalent to serial (RS-422) output.

<NOTE>

- When forwarding to more than one client, the timing of transmitting the UDP packet to the second and subsequent client will always be delayed relative to the Genlock signal.
(Approximately 200 to 300 μs delay will occur for each client. The latency may be increased depending on the system status or the network environment of the unit.)
- When [IP] is [On], video transmission via IP may be delayed or the video may suffer frame loss.
We recommend setting [IP] to [Off] to avoid the delay or frame loss due to the video transmission via IP.
- In the following cases, the tracking data output may be delayed or the value may not be updated.
 - When performing video transmission via IP (M-JPEG/H.264/H.265/RTMP/RTMPS/NDI/NDI|HX/SRT)
 - When opening the web screen (live screen [Live] or the web setting screen [Setup])
 - While viewing the OSD menu
 - While recalling the preset value during an ongoing preset recall
 - When executing AWB/ABB
 - When a red or a green tally signal input has been changed between Off and On
 - When deleting a preset memory
 - When an output image is flipped (turned upside down or left-right reversed)
 - After switching [Scene]
 - After switching [Iris Mode]
 - After switching [Super Gain]
 - After switching [White Balance Mode]
 - After switching [Gamma Mode]
 - After switching [Matrix Type]
 - After switching [Focus Mode]
 - After switching [Zoom Mode]
 - After switching [Max Digital Zoom]
 - After switching [Digital Extender]
 - After switching [Fan]
 - After switching [OSD Mix]
 - After switching [Tally]
 - After switching [Install Position]
 - After switching [Preset Speed Unit]
 - When executing [Initialize] of [Maintenance]

Output 1/5 screen

```

## Output 1/5 ##
⇨ 3G SDI
  Format                1080/59.94p
  3G SDI Out           LevelA
  HDMI
  Format                2160/29.97p
  Video Sampling       4:2:2/10bit

Return
    
```

3G SDI

Make the settings for output from the 3G SDI OUT connector.

Format

Set the output format.

The following format settings are possible depending on the [Format] setting in the [System 1/2] screen.

Frequency	System Format	Format (3G SDI)
59.94Hz	2160/59.94p	1080/59.94p 1080/59.94i
	2160/29.97p	1080/29.97p
	1080/59.94p	1080/59.94p 1080/59.94i
	1080/59.94i	1080/59.94i
	1080/29.97p	1080/29.97p
	1080/29.97PsF	1080/29.97PsF
	1080/23.98p(59.94i)*1	1080/23.98p(59.94i)*1
	720/59.94p	720/59.94p
	50Hz	2160/50p
2160/25p		1080/25p
1080/50p		1080/50p 1080/50i
1080/50i		1080/50i
1080/25p		1080/25p
1080/25PsF		1080/25PsF
720/50p		720/50p
24Hz		2160/24p
	1080/24p	1080/24p
23.98Hz	2160/23.98p	1080/23.98p
	1080/23.98p	1080/23.98p
	1080/23.98PsF	1080/23.98PsF

*1 It denotes "1080/23.98p over 59.94i".

3G SDI Out [LevelA, LevelB]

When [Format] (3G SDI) is [1080/59.94p] or [1080/50p], select the format for outputting 3G SDI signals.

LevelA	Level A format
LevelB	Level B format

<NOTE>

- [3G SDI Out] cannot be changed if [Format] (3G SDI) is other than [1080/59.94p] or [1080/50p].

Camera menu items (continued)

HDMI

Make the settings for output from the HDMI connector.

Format

Set the output format.

The following format settings are possible depending on the [Format] setting in the [System 1/2] screen.

Frequency	System Format	Format (HDMI)
59.94Hz	2160/59.94p	2160/59.94p
		1080/59.94p
	2160/29.97p	2160/29.97p
		1080/29.97p
	1080/59.94p	1080/59.94p
	1080/59.94i	1080/59.94i
	1080/29.97p	1080/29.97p
	1080/29.97PsF	1080/29.97p
1080/23.98p(59.94i)* ¹	1080/23.98p(59.94p)* ²	
50Hz	2160/50p	2160/50p
		1080/50p
	2160/25p	2160/25p
		1080/25p
	1080/50p	1080/50p
	1080/50i	1080/50i
	1080/25p	1080/25p
	1080/25PsF	1080/25p
720/50p	720/50p	
24Hz	2160/24p	2160/24p
		1080/24p
23.98Hz	2160/23.98p	2160/23.98p
		1080/23.98p
	1080/23.98PsF	1080/23.98p

*¹ It denotes "1080/23.98p over 59.94i".

*² It denotes "1080/23.98p over 59.94p".

Video Sampling [4:2:2/10bit, 4:2:0/8bit]

When [Format] in [HDMI] is [2160/59.94p] or [2160/50p], select the video sampling output from the HDMI connector.

4:2:2/10bit	Output in 4:2:2/10bit mode.
4:2:0/8bit	Output in 4:2:0/8bit mode.

<NOTE>

- When [Format] in [HDMI] is other than [2160/59.94p] or [2160/50p], [Video Sampling] cannot be changed and is fixed at [4:2:2/10bit].

Return

Return to the previous menu level.

Output 2/5 screen

```

## Output 2/5 ##
⇨ Bar                               Camera
  Color Bar Type                     Type2
  Tone                               Normal
  Audio                               Off
  Input Type                          Line
  Volume Level CH1                    0dB
  Volume Level CH2                    0dB
  Plugin Power                        Off

Return
    
```

Bar [Camera, Colorbar]

Switch between camera images and color bars.

Camera	Camera images
Colorbar	Color bar

Color Bar Type [Type1, Type2]

Select the type of color bar to display.



This is only enabled when [Bar] is set to [Colorbar].

Tone [Off, Low, Normal]

Make the settings for the test tone signal (1 kHz) output while the color bar is displayed.

Off	Test tone is not output.
Low	Test tone is output at low volume.
Normal	Test tone is output at normal volume.

This is only enabled when [Bar] is set to [Colorbar].

Audio [Off, On]

Turn audio input off/on.

Input Type [Mic, Line]

Mic	Set the microphone input.
Line	Set the line input.

This is only enabled when [Audio] is set to [On].

Volume Level CH1 [-36dB to +12dB]

Set the volume of audio output (CH1).

This is only enabled when [Audio] is set to [On].

Volume Level CH2 [-36dB to +12dB]

Set the volume of audio output (CH2).

This is only enabled when [Audio] is set to [On].

Plugin Power [Off, On]

Turn the plugin power for the audio off/on.

This is only enabled when [Audio] is set to [On].

This is only enabled when [Input Type] is set to [Mic].

Return

Return to the previous menu level.

Output 3/5 screen

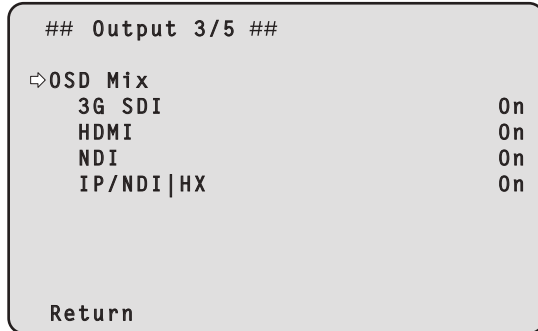

OSD Mix

Selects whether to turn Off/On the camera menu and status displays.

3G SDI [Off, On]

Selects whether to turn this Off/On for images output from 3G SDI OUT connector.

HDMI [Off, On]

Selects whether to turn this Off/On for images output from HDMI connector.

NDI [Off, On]

Selects whether to turn this Off/On for images of NDI output from the LAN connector.

IP/NDI|HX [Off, On]

Selects whether to turn this Off/On for images other than NDI images (H.264/H.265/JPEG/RTMP/SRT/NDI|HX) output from the LAN connector.

Off	The camera menus and statuses are not displayed on the output pictures covered by the setting items listed above.
On	The camera menus and statuses are displayed on the output pictures covered by the setting items listed above.

<NOTE>

- When this is set to [Off], the camera menu can be displayed for about 1 minute after the unit is turned on.

Return

Return to the previous menu level.

Output 4/5 screen

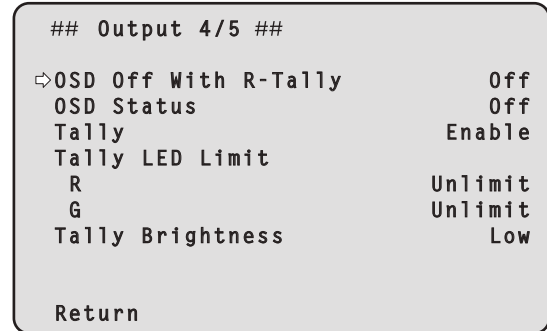

OSD Off With R-Tally [Off, On]

Off or on the function that turns off camera menu, status and other displays when red tally signals are received via commands or contacts.

When the red tally signal releases, the camera menu display will return.

OSD Status [Off, On]

Turn the status display during AWB and ABB off/on, or error display when an error occurs.

Tally

[Enable, Disable]

[Disable] or [Enable] is set here for the function which turns on or turns off the tally lamp using the tally control signal.

Tally LED Limit

Sets whether to limit the lighting of the tally lamp for each of the tally control signal colors (R/G).

R [Limit, Unlimit]

G [Limit, Unlimit]

Limit	Limit the lighting of the tally lamp.
Unlimit	Light the tally lamp.

<NOTE>

- If [Limit] is selected for [Tally LED Limit], only the tally lamp of this unit is limited. The tally status display on external devices (the AW-RP150, AW-RP60 controller, etc.) remains enabled.

Tally Brightness [Low, Mid, High]

Adjust the brightness of the tally LED.

Return

Return to the previous menu level.

Output 5/5 screen

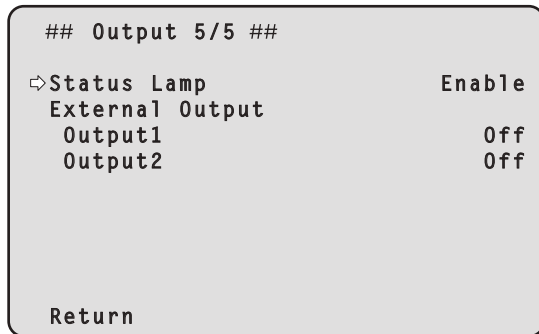

Status Lamp

[Enable, Disable]

[Disable] or [Enable] is set here for the status display lamp. When you want the status display lamp to stay off while this unit is in operation, set to [Disable].

<NOTE>

- Even when set to [Disable], the status display lamp may light up when this unit is starting up, updating firmware, or trouble is occurring.

External Output

Select the signal type output from the External Output signal lines (Output1, Output2) of the RS-422 connector. (→ page 17)

Output1 [Off, R-Tally, G-Tally]

Output2 [Off, R-Tally, G-Tally]

Off	Signal is not output.
R-Tally	The reception status of the red tally signal is output.
G-Tally	The reception status of the green tally signal is output.

Return

Return to the previous menu level.

Pan/Tilt screen

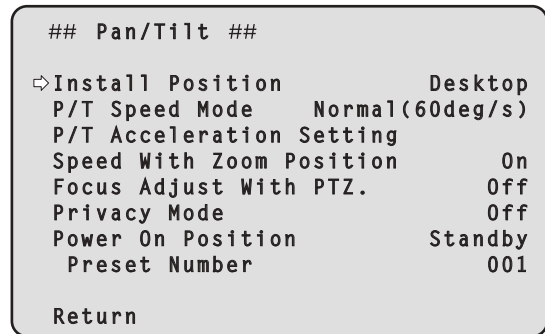

Install Position

[Desktop, Hanging]

[Desktop] or [Hanging] is selected here as the method used to install the unit.

Desktop	Stand-alone installation
Hanging	Suspended installation

<NOTE>

- When [Hanging] has been selected, the top, bottom, left and right of the images will be reversed, and up/down/left/right control for panning and tilting will also be reversed.

P/T Speed Mode [Normal(60deg/s), Fast1(90deg/s), Fast2(180deg/s)]

Set the speed of pan/tilt operation.

Normal(60deg/s)	Pan/tilt operates at normal speed (maximum about 60° per second).
Fast1(90deg/s)	Pan/tilt operates at fast speed1 (maximum about 90° per second).
Fast2(180deg/s)	Pan/tilt operates at fast speed2 (maximum about 180° per second).

P/T Acceleration Setting

Displays the advanced setting screen for setting the acceleration speed while starting/stopping a pan/tilt operation. (→ page 64)

Speed With Zoom Position [Off, On]

[Off] or [On] is set here for the function used to adjust the pan-tilt adjustment speed in conjunction with the zoom magnification.

When [On] is set, the panning and tilting operations will become slower in the zoom status.

This function has no effect during preset operations.

Focus Adjust With PTZ. [Off, On]

[Off] or [On] is set here for the function which compensates for out-of-focusing when it occurs during panning, tilting or zooming operations. When [Off] is set, adjust the focus as required after zooming or set [Focus Mode] to [Auto].

This is only enabled when [Manual] has been selected as the [Focus Mode] setting.

Privacy Mode [Off, On]

Sets Off/On the function for facing the camera to the rear when this unit is switched to Standby mode.

Off	Does not change the camera direction when the camera is switched to Standby mode. (The camera remains in the direction it was when the power was turned On)
On	Moves the camera to face toward the rear when the camera is switched to Standby mode. Moves the camera to the position specified in [Power On Position] when the power is turned On again.

Camera menu items (continued)

Power On Position [Standby, Home, Preset]

Select the initial positions for Pan/Tilt/Zoom when the power is turned on.

Standby	Move to the Pan/Tilt/Zoom positions they were in the last time the camera was switched to Standby mode.
Home	Pan/Tilt move to their home positions (front) and Zoom goes to the Wide end.
Preset	Preset playback is performed at the preset position specified with [Preset Number].

Preset Number [001 to 100]

Specify a number for preset playback when the power turns ON when [Preset] is set in [Power On Position].

<NOTE>

- If an unregistered preset number is set, preset playback is not performed and the operation is the same as [Standby].

Return

Return to the previous menu level.

P/T Acceleration screen

### P/T Acceleration ###	
⇨ P/T Acceleration	Auto
Rise S-Curve	15
Fall S-Curve	15
Rise Acceleration	128
Fall Acceleration	128
Return	

P/T Acceleration [Manual, Auto]

Sets whether to perform advance setting for acceleration and deceleration etc. during manual operation of pan/tilt.

Manual	Sets the advanced settings for acceleration speed etc. during start/stop or changing the speed of pan/tilt operation.
Auto	Sets the settings for automatic acceleration and deceleration speed etc. during start/stop or changing the speed of pan/tilt operations.

Rise S-Curve [0 to 30]

Sets the S-curve for pan/tilt acceleration operation in 31 steps. (The S becomes stronger, the greater the number)

When it is necessary to increase the speed to the specified speed using manual control of pan/tilt by lever operation etc. through the controller, the acceleration process is performed based on the S-curve specified in this setting.

This is enabled only when [P/T Acceleration] is [Manual].

<NOTE>

- In order to limit the acceleration response, in the S-curve step, as the acceleration speed rises, the limit is automatically applied.

Fall S-Curve [0 to 30]

Sets the S-curve for pan/tilt deceleration operation in 31 steps. (The S becomes stronger, the greater the number)

When it is necessary to reduce the speed to the specified speed using manual control of pan/tilt by lever operation etc. through the controller, the deceleration process is performed based on the S-curve specified in this setting.

This is enabled only when [P/T Acceleration] is [Manual].

<NOTE>

- In order to limit the deceleration response, in the S-curve step, as the deceleration speed rises, the limit is automatically applied.

Rise Acceleration [1 to 255]

Sets the acceleration speed for pan/tilt acceleration operation in 255 steps. (The acceleration speed increases as the number increases)

When it is necessary to increase the speed to the specified speed using manual control of pan/tilt by lever operation etc. through the controller, the acceleration process is performed based on the acceleration speed specified in this setting.

This is enabled only when [P/T Acceleration] is [Manual].

<NOTE>

- When the specified acceleration speed is small, it is not possible to reach the maximum speed of the product.

Camera menu items (continued)

Fall Acceleration [1 to 255]

Sets the deceleration speed for pan/tilt deceleration operation in 255 steps. (The deceleration speed increases as the number increases)
When it is necessary to reduce the speed to the specified speed using manual control of pan/tilt by lever operation etc. through the controller, the deceleration process is performed based on the deceleration speed specified in this setting.

This is enabled only when [P/T Acceleration] is [Manual].

<NOTE>

- The deceleration and stop processes are carried out right up to the end of the lens mechanism section and in order to prevent a collision with the mechanism, in the actual operation, [Fall Acceleration] may be restricted.

Return

Return to the previous menu level.

■ The relationships between the various setting values during manual operation of pan/tilt when [P/T Acceleration] is set to [Manual]

It is possible to specify the responsiveness (maximum speed, acceleration rate, S-curve steps) for operation.

<NOTE>

- When the specified acceleration speed is small, it is not possible to reach the maximum speed of the product.

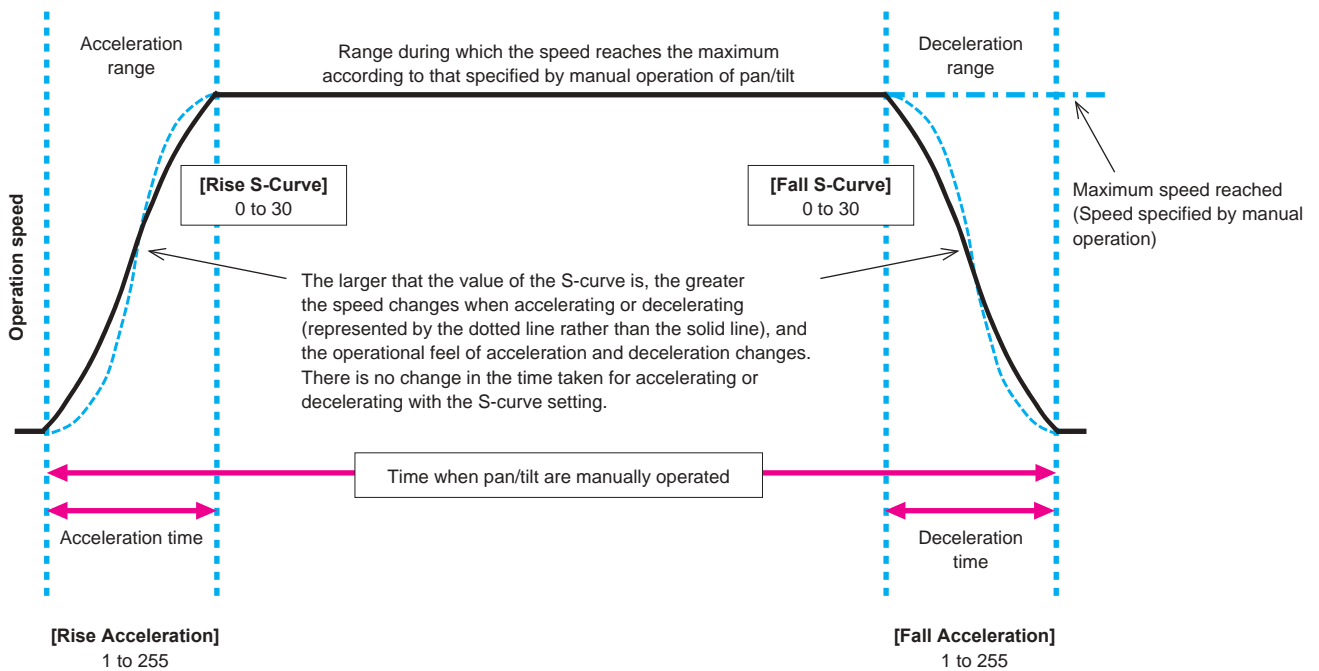

The larger the value, the shorter the acceleration time
(It takes less time to reach the speed specified with manual pan/tilt operation)

The larger the value, the shorter the deceleration time
(It takes less time to reach the deceleration or stopped status specified with manual pan/tilt operation)

Preset 1/2 screen

```

## Preset 1/2 ##
  Preset Speed Unit      Speed Table
  Preset Speed Table    Fast
  Preset Speed          20
  Preset Acceleration Setting
  Preset Scope          Mode A
  Preset Digital Extender Off
  Preset Thumbnail Update On
  Preset Name           Reset

Return
    
```

Preset Speed Unit [Speed Table, Time]

When reproducing the information such as camera direction registered in the preset memory, you can select whether to specify the playback time by speed or by time.

Speed Table	Specify the speed when playing during preset playback.
Time	Specify the time when playing during preset playback.

Preset Speed Table [Slow, Fast]

Set the preset speed table (Slow, Fast). During preset playback, presets are performed at [Preset Speed] (1 to 30) values that are based on the table set here. This is only enabled when [Preset Speed Unit] is set to [Speed Table].

Preset Speed [1 to 30/1s to 99s]

When [Preset Speed Unit] is [Speed Table]: [1 to 30]

Set the pan/tilt operation speed in 30 steps when playing back the preset memory.

<NOTE>

- When you set large [Preset Speed] values, the image may sway when the movement stops.

When [Preset Speed Unit] is [Time]: [1s to 99s]

Set the pan/tilt operation time between 1 and 99 seconds when playing back the preset memory.

<NOTE>

- Depending on the movement distance of pan/tilt, there may be a difference compared to the specified time.

Preset Acceleration Setting

Displays the advanced setting screen for setting acceleration speed when starting/stopping preset playback. (→ page 67)

Preset Scope [Mode A, Mode B, Mode C]

Selected here are the setting items to be recalled when the contents of the preset memory are regenerated.

Mode A	Pan, Tilt, Zoom (including digital zoom), Focus, Iris, Gain, white balance adjustment value
Mode B	Pan, Tilt, Zoom (including digital zoom), Focus, Iris
Mode C	Pan, Tilt, Zoom (including digital zoom), Focus

Preset Digital Extender [Off, On]

Turns the preset digital extender function off/on. When set to [On], the digital extender function configuration will be recalled when regenerating the preset memory. When set to [Off], the digital extender function configuration will not be recalled when storing the preset memory.

Preset Thumbnail Update [Off, On]

Turn off/on the function for registering the still image (thumbnail) for the images being output when a preset memory is registered. When set to [On], the still image (thumbnail) for the images being output is registered when registering a preset memory. When set to [Off], the still image (thumbnail) for the images being output is not registered when registering a preset memory, but rather the still image (thumbnail) previously registered is maintained.

<NOTE>

- When [IP/HDI|HX] of [OSD Mix] is [On], the character strings of OSD menu displayed during the generation of still images (thumbnails) are imported to the thumbnails.
- When uploading Camera(ALL), Camera(SYSTEM) or Camera(PRESET) on the web screen or other access, the still image (thumbnail) that has been registered in preset memory will be erased. (→ page 146)

Preset Name [Reset, Hold]

When registering a preset memory, set whether to reset the previously registered preset name or keep it.

Reset	When registering a preset memory, reset the previously registered preset name. The preset name after resetting will be [Preset***]. (***) is a 3 digit preset number: 001 to 100)
Hold	When registering a preset memory, keep the previously registered preset name.

<NOTE>

- The factory default setting for the preset name is [Preset***]. (***) is a 3 digit preset number: 001 to 100)
- The registration of preset names can be done in the web browser. 0 to 9, A to Z, a to z, _ , and space

Return

Return to the previous menu level.

Preset 2/2 screen

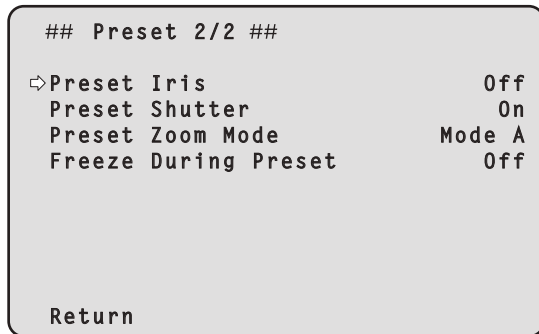

Preset Iris [Off, On]

When the preset memory is played back, set whether the reproduction of the values in the various menus related to Iris is off/on.

When set to [On], the values set in the various menus below are reproduced when preset memory is played back.

- Picture Level
- Iris Mode
- Auto Iris Speed
- Auto Iris Window

<NOTE>

- Its setting takes effect when [Mode A] or [Mode B] has been selected as the [Preset Scope] setting.

Preset Shutter [Off, On]

When the preset memory is played back, set whether the reproduction of the Shutter setting value is Off/On.

<NOTE>

- This is enabled when [Preset Scope] is [Mode A].
- The Shutter values are reproduced only when the frame rate when the preset memory was registered and the frame rate when playing back the preset memory match.

Preset Zoom Mode [Mode A, Mode B]

Select the zoom operation for when preset memory is recalled.

Mode A	Perform the zoom operation in line with the pan/tilt operation.
Mode B	Perform the zoom operation quicker than the pan/tilt operation.

Freeze During Preset [Off, On]

Turn the function for freezing images during preset playback off/on. When this is set to [On], preset playback is performed with a still of the image immediately preceding the start of preset playback being output. The image freeze is released when preset playback is finished.

Return

Return to the previous menu level.

Preset Acceleration screen

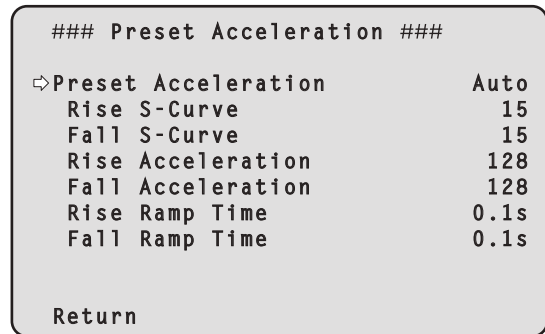

Preset Acceleration [Manual, Auto]

Sets whether to perform advance setting for acceleration and deceleration speed etc. during start/stop of preset playback.

Manual	Makes the advance settings for acceleration speed etc. when starting/stopping preset playback.
Auto	Automatically operates acceleration speed etc. when starting/stopping preset playback.

Rise S-Curve [0 to 30]

Sets the S-curve for pan/tilt acceleration operation in 31 steps. (The S becomes stronger, the greater the number)

During the acceleration operation for operating at the specified speed or time during pan/tilt operations by preset playback, the acceleration process is performed using the S-curve specified in this setting. This is enabled only when [Preset Acceleration] is [Manual].

<NOTE>

- In order to limit the acceleration response, in the S-curve step, as the acceleration speed rises, the limit is automatically applied.

Fall S-Curve [0 to 30]

Sets the S-curve for pan/tilt deceleration operation in 31 steps. (The S becomes stronger, the greater the number)

During the fall acceleration operation for operating at the specified speed or time during pan/tilt operations by preset playback, the deceleration process is performed using the S-curve specified in this setting.

This is enabled only when [Preset Acceleration] is [Manual].

<NOTE>

- In order to limit the deceleration response, in the S-curve step, as the deceleration speed rises, the limit is automatically applied.

Rise Acceleration [1 to 255]

Sets the acceleration speed for pan/tilt acceleration operation in 255 steps. (The acceleration speed increases as the number increases)

During the acceleration operation for operating at the specified speed or time during pan/tilt operations by preset playback, the acceleration process is performed using the acceleration speed specified in this setting.

This is enabled only when [Preset Acceleration] is [Manual] and [Preset Speed Unit] is [Speed Table].

<NOTE>

- As the speed specified for [Preset Speed] is given priority as the maximum speed attained in preset playback, if the acceleration speed specified here is small, this functionality may not operate as specified.

Fall Acceleration [1 to 255]

Sets the deceleration speed for pan/tilt deceleration operation in 255 steps. (The deceleration speed increases as the number increases)

During the deceleration operation for operating at the specified speed or time during pan/tilt operations by preset playback, the deceleration process is performed using the deceleration speed specified in this setting.

This is enabled only when [Preset Acceleration] is [Manual] and [Preset Speed Unit] is [Speed Table].

<NOTE>

- As the speed specified for [Preset Speed] is given priority as the maximum speed attained in preset playback, if the deceleration speed specified here is small, this functionality may not operate as specified.

Camera menu items (continued)

Rise Ramp Time [0.1s to 10.0s]

Sets the acceleration time for the time specific operation during preset playback. (Sets between 0.1 s to 10.0 s in 0.1 s increments)
This is enabled only when [Preset Acceleration] is [Manual] and [Preset Speed Unit] is [Time].

<NOTE>

- As the time specified in [Preset Speed] takes precedence as the total time for preset playback, if the time specified here is more than half of the time specified in [Preset Speed], this functionality will not operate as specified.
- When the acceleration operation cannot be performed within the specified time even at maximum acceleration speed of the device, the operation will not be performed by the specified time.

Fall Ramp Time [0.1s to 10.0s]

Sets the deceleration time for time specified operations during preset playback. (Sets between 0.1 s to 10.0 s in 0.1 s increments)
This is enabled only when [Preset Acceleration] is [Manual] and [Preset Speed Unit] is [Time].

<NOTE>

- As the time specified in [Preset Speed] takes precedence as the total time for preset playback, if the time specified here is more than half of the time specified in [Preset Speed], this functionality will not operate as specified.
- When the deceleration operation cannot be performed within the specified time even at maximum fall deceleration of the device, the operation will not be performed by the specified time.

Return

Return to the previous menu level.

■ The relationships between the various setting values when [Preset Acceleration] is set to [Manual] during preset playback

● When [Preset Speed Unit] is [Speed Table]

It is possible to specify the responsiveness (maximum speed, acceleration rate, S-curve steps) for operation.

<NOTE>

- When the amount of movement specified by the preset is small, there may be cases when the specified speed is not reached.
- Restrictions are automatically placed on the acceleration rate to prioritize the specified speed. (The lower limit of the acceleration rate is automatically restricted by the specified speed.)
- To enable the pan and tilt operations to occur simultaneously, the maximum speed of the axis with a smaller amount of movement is automatically restricted.

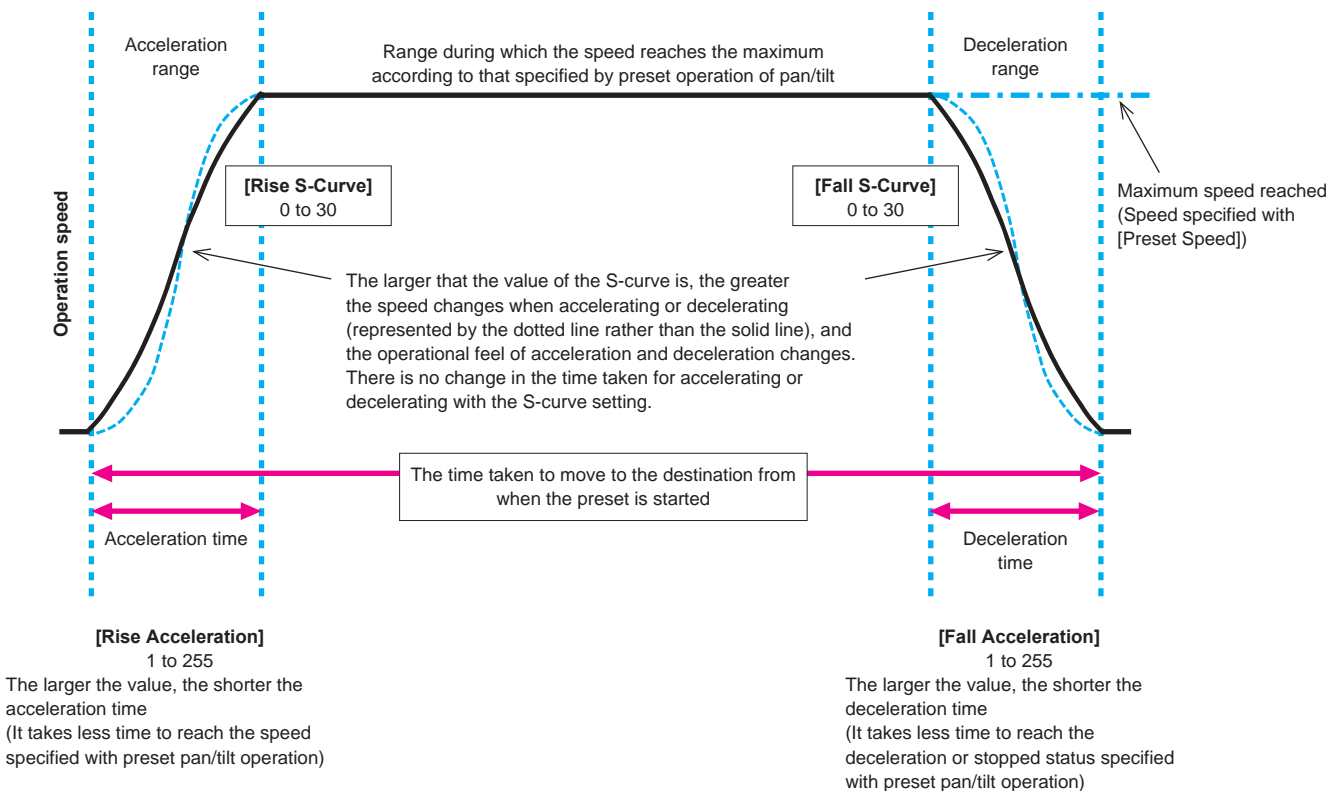

Camera menu items (continued)

● When [Preset Speed Unit] is [Time]

It is possible to specify the times (time taken to move, time taken to accelerate, time taken to decelerate) and the S-curve steps for operation.

<NOTE>

- When the acceleration operation cannot be performed within the specified time even at maximum acceleration speed of the device, the operation will not be performed by the specified time.
- As the time specified in [Preset Speed] takes precedence as the total time for preset playback, if the times specified in [Rise Ramp Time] and [Fall Ramp Time] are more than half of the time specified in [Preset Speed], this will not operate as specified.

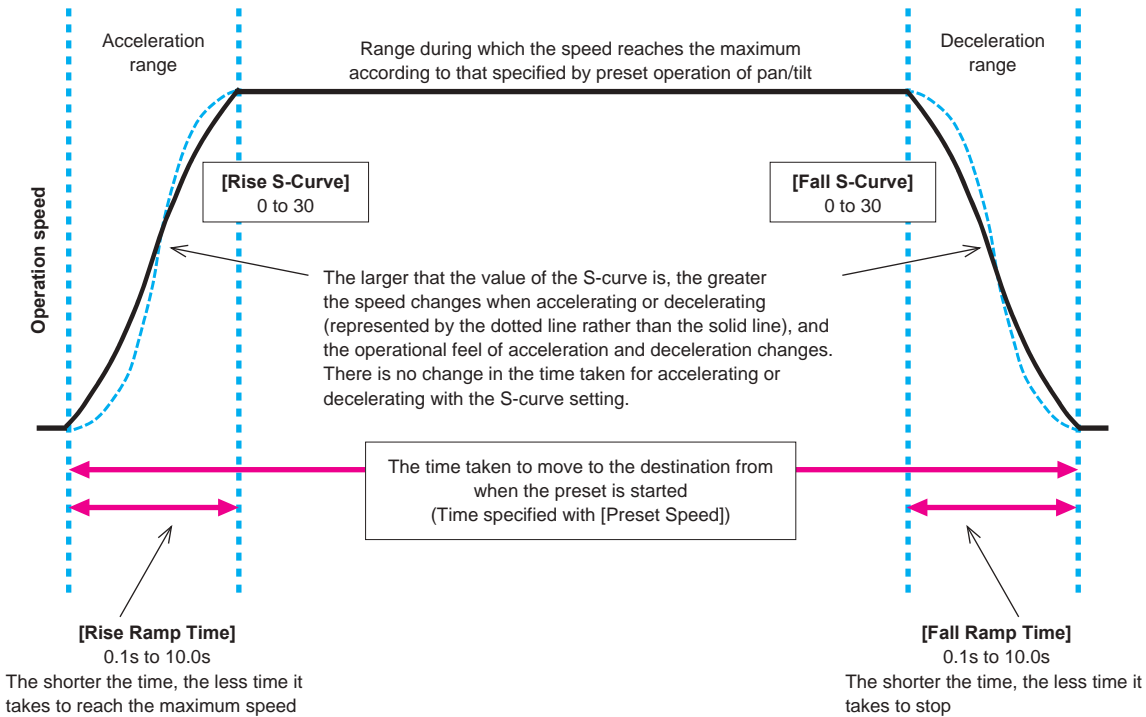

Maintenance screen

```
## Maintenance ##  
⇨ Firmware Version  
IP Network  
Scene Copy  
Initialize  
Hour Meter  
HDMI Status  
Error Status  
  
Return
```

Firmware Version

This is selected to display the [Firmware Version] screen on which the user can check the version of the firmware which is currently installed in the unit.

IP Network

This is selected to display the [IP Network] screen on which the user can check and make settings for the [IP Address], [Subnet Mask] and [Default Gateway] settings which have been set in the unit.

Scene Copy

This is selected to copy the various bits of Scene data recorded in the camera ([Full Auto]/[Scene1]/[Scene2]/[Scene3]) to each other.

Initialize

This is selected to display the [Initialize] screen on which the user can initialize the camera settings.

For details on operation, refer to "Concerning initialization" (→ page 73).

Hour Meter

This is selected to display the [Hour Meter] screen on which the operation history is displayed.

HDMI Status

Display the [HDMI Status] screen that displays the status of HDMI output.

Error Status

Display the [Error Status] screen that displays the status of errors.

Return

Return to the previous menu level.

Firmware Version 1/2 screen

```
### Firmware Version 1/2 ###  
System Version          V01.00  
  
CPU Software  
Main/Network           V01.00  
Camera                 V01.00  
Lens                   V01.00  
Servo                  V01.00  
  
⇨ Return
```

System Version

Display the version for overall system of the unit.

CPU Software

Main/Network

Display the main/network software version.

Camera

Display the software version of the camera.

Lens

Display the software version of the lens.

Servo

Display the software version of the servo.

Return

Return to the previous menu level.

Firmware Version 2/2 screen

```

### Firmware Version 2/2 ###
EEPROM
Main/Network          V01.00
FPGA
Network              V01.00
Enc                  V01.00
Logic                 V01.00

⇨ Return
    
```

EEPROM

Main/Network

Display the EEPROM version of the main/network.

FPGA

Network

Displays the version of the Network module.

Enc

Displays the version of the image compression module.

Logic

Displays the version of the main functional part of FPGA.

Return

Return to the previous menu level.

IP Network screen

```

### IP Network ###
IP Address              192.168.0.10
Subnet Mask            255.255.255.0
Default Gateway        192.168.0.1

Set Execute

⇨ Return
    
```

IP Address

Set the IP address for this unit.

The set value is applied to this unit when [Set Execute] is executed.

Subnet Mask

Set the subnet mask for this unit.

The set value is applied to this unit when [Set Execute] is executed.

Default Gateway

Set the default gateway for this unit.

The set value is applied to this unit when [Set Execute] is executed.

Set Execute

Apply the values set in [IP Address], [Subnet Mask], and [Default Gateway] to this unit.

Return

Return to the previous menu level.

<NOTE>

- The IP Network cannot be changed while the DHCP function is [On].
- If the DHCP function is not to be used, change the setting for [DHCP] to [Off] in the network settings screen of your web browser. (→ page 127)

Scene Copy screen

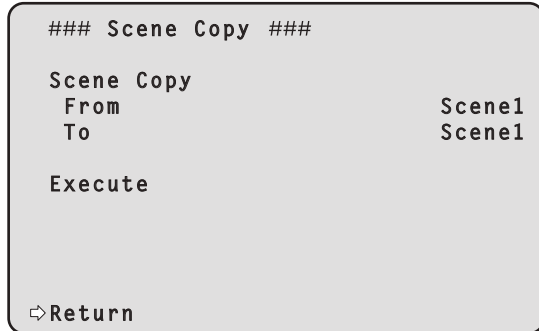

Scene Copy

This is selected to copy the various bits of Scene data recorded in the camera ([Full Auto]/[Scene1]/[Scene2]/[Scene3]) to each other.

From [Full Auto, Scene1, Scene2, Scene3]

Select the Scene to copy data from.

To [Full Auto, Scene1, Scene2, Scene3]

Select the Scene to copy data to.

<NOTE>

- When copying between [Full Auto], and [Scene1] to [Scene3], some setting values may be changed according to some exclusive conditions.
- When [From] is [Full Auto], for items that are operating as [Auto], the operating setting values are applied at the time that the copy is implemented.

Return

Return to the previous menu level.

Initialize screen

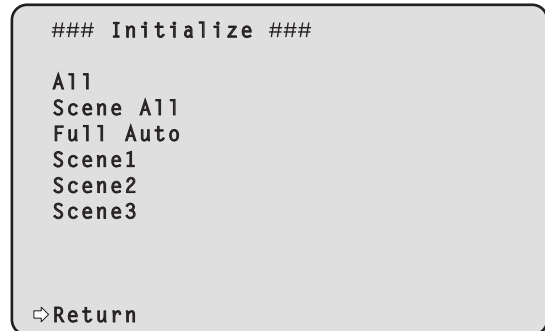

All

All the set values of the OSD menu are restored to the factory settings.

<NOTE>

The following items are not initialized:

- Network settings
- [AWB] and [ABB] adjustment values
- Information registered in the preset memories
- [Frequency] on the [System 1/2] screen
- [Format] on the [System 1/2] screen
- [Format] of [3G SDI] and [HDMI] on the [Output 1/5] screen

Scene All

From the set values of OSD menu, the set values of all data (Full Auto, Scene1 to 3) saved as a scene file are restored to the factory settings.

The data saved as a scene file includes each of the values set on the screen enclosed within "*" on the OSD menu screen title.

(The data not saved as a scene file includes each of the values set on the screen enclosed within "#" on the OSD menu screen title.)

Full Auto

Scene1

Scene2

Scene3

From the set values of OSD menu, the set values of the specified scene number (any one from Full Auto, Scene1 to 3) in the data saved as a scene file are restored to the factory settings.

Return

Return to the previous menu level.

■ Concerning initialization

When any one of [All/Scene All/Full Auto/Scene1/Scene2/Scene3] is selected on the [Initialize] screen, the Initialize confirmation screen is displayed.

Initialize confirmation screen

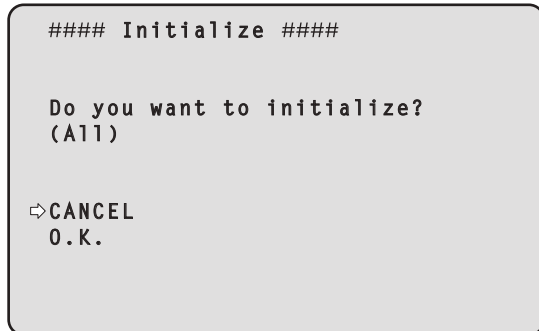

- When the cursor is moved to [O.K.] on the Initialize confirmation screen and the setting is entered, the Initialize completed screen is displayed for 5 seconds, and the camera settings are restored to the settings which were established when the camera was purchased.

Initialize completed screen

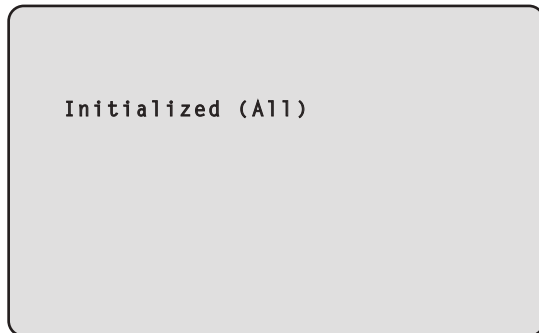

- When the cursor is moved to [CANCEL] on the Initialize confirmation screen and the setting is entered, the Initialize cancel screen is displayed for 5 seconds, the initialization operation is not performed, and the [Initialize] screen returns to the display.

Initialize cancel screen

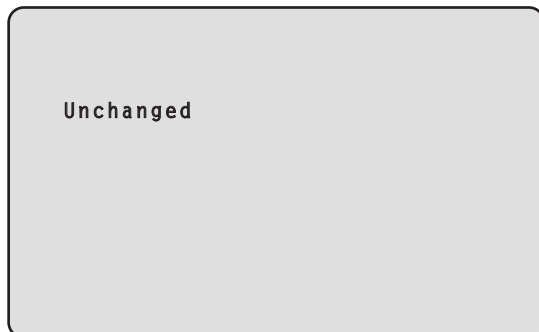

Hour Meter screen

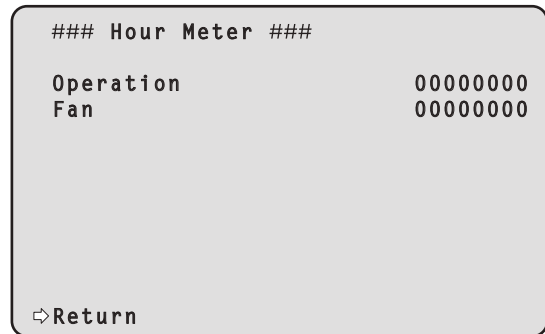

Operation

Displays the cumulative time that power has been supplied to the unit. (8-digit numerical value)

Fan

Display the cumulative hours of operation of the cooling fan. (8-digit numerical value)

Return

Return to the previous menu level.

HDMI Status screen

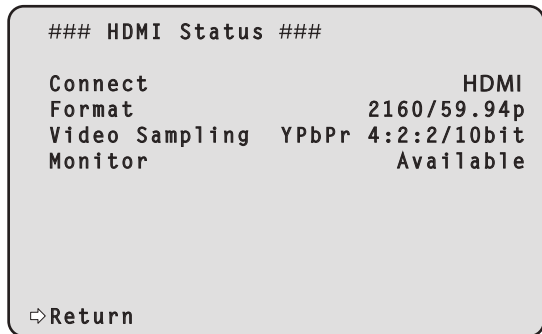

Connect

Displays the connection status of the HDMI connector. One of the following is displayed according to the product specifications of the device or monitor connected.

Unconnect	Not connected.
HDMI	Connected via HDMI.
DVI	Connected via DVI.

Format

Displays the format of the images being output via the HDMI connector. The same format is displayed as is specified in [Format] in [HDMI] in the [Output 1/5] screen.

Video Sampling

The video sampling of the images being output via the HDMI connector is displayed. One of the following is displayed according to the menu settings and the product specifications of the device or monitor connected.

---	Displayed when [Connect] is other than HDMI.
RGB 8bit	Displayed when [Connect] is HDMI and output is RGB 8bit.
YPbPr 4:2:2/10bit	Displayed when [Connect] is HDMI and output is YPbPr 4:2:2/10bit.
YPbPr 4:2:0/8bit	Displayed when [Connect] is HDMI and output is YPbPr 4:2:0/8bit.

<NOTE>

- Even if the video sampling is set in [Video Sampling] in [HDMI] in the [Output 1/5] screen, it may not be possible to output using the specified format due to the product specifications of the HDMI connected device or monitor. This item displays the status of the video sampling actually being output.

Monitor

Displays the status of the device or monitor connected to the HDMI connector. One of the following is displayed according to the product specifications of the device or monitor connected.

---	Displayed when [Connect] is other than HDMI.
Available	This indicates that [Connect] is HDMI and the device or monitor connected supports the format output by this unit.
Unsupport UHD	This indicates that [Connect] is HDMI and the device or monitor connected does not support the format output by this unit.
Unsupport UHD 60p/50p	
Unsupport UHD 60p 4:2:2	
Unsupport UHD 50p 4:2:2	
Unsupport UHD 60p 4:2:0	
Unsupport UHD 50p 4:2:0	This indicates that [Connect] is HDMI and the device or monitor connected is not supported for a reason other than those shown above.
Unsupport Format	

Return

Return to the previous menu level.

Error Status screen

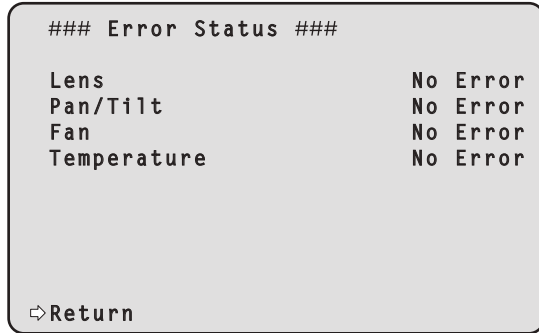

Lens [No Error, Error]

This displays the error status of the lens.

No Error	The lens is operating normally.
Error	A lens error has occurred.

Pan/Tilt [No Error, Error]

This displays the error status of the pan-tilt drive section.

No Error	The pan-tilt drive section is operating normally.
Error	A pan-tilt drive section error has occurred.

Fan [No Error, Error]

This displays the error status of the fan.

No Error	The fan is operating normally.
Error	A fan error has occurred.

Temperature [No Error, High Temperature, Sensor Error]

This displays the status of temperature related errors.

No Error	Within normal operating temperature range.
High Temperature	Temperature is high.
Sensor Error	The temperature sensor may have malfunctioned.

<NOTE>

- When the above errors occur, notification of the errors are sent via IP/serial to the external device (AW-RP150 or AW-RP60, etc.), so these errors can be displayed on the external device.

Return

Return to the previous menu level.

Camera menu item table

Camera menu			Item	Factory setting				Selection items	
Top Menu	Camera	Scene	Scene	Full Auto				Full Auto, Scene1, Scene2, Scene3	
			(The factory settings differ for each Scene mode)						
		Brightness 1/3	Picture Level	0				-50 to +50 (step: 1)	
			Iris Mode	---	Auto	Auto	Manual	Manual, Auto	
			Auto Iris Speed	Normal				Slow, Normal, Fast	
			Auto Iris Window	Normal1				Normal1, Normal2, Center	
			Iris Limit	---	Off			Off, On	
			Shutter Mode	---	ELC	Off		Off, Step, Synchro, ELC	
			Step/Synchro (When [Shutter Mode] is set to [Step])	[59.94Hz] --- (1/100) [50Hz] --- (1/120)	[59.94Hz] 1/100 [50Hz] 1/120			<ul style="list-style-type: none"> • 59.94p/59.94i mode 1/60, 1/100, 1/120, 1/250, 1/500, 1/1000, 1/2000, 1/4000, 1/8000, 1/10000 • 29.97p mode 1/30, 1/60, 1/100, 1/120, 1/250, 1/500, 1/1000, 1/2000, 1/4000, 1/8000, 1/10000 • 23.98p/24p mode 1/24, 1/48, 1/60, 1/100, 1/120, 1/250, 1/500, 1/1000, 1/2000, 1/4000, 1/8000, 1/10000 • 50p/50i mode 1/60, 1/100, 1/120, 1/250, 1/500, 1/1000, 1/2000, 1/4000, 1/8000, 1/10000 • 25p mode 1/25, 1/50, 1/60, 1/100, 1/120, 1/250, 1/500, 1/1000, 1/2000, 1/4000, 1/8000, 1/10000 	
			Step/Synchro (When [Shutter Mode] is set to [Synchro])	[59.94Hz] --- (60.0Hz) [50Hz] --- (50.0Hz)	[59.94Hz] 60.0Hz [50Hz] 50.0Hz			<ul style="list-style-type: none"> • 59.94p/59.94i mode 60.0 Hz to 7200 Hz • 29.97p mode 30.0 Hz to 7200 Hz • 23.98p/24p mode 24.0 Hz to 7200 Hz • 50p/50i mode 50.0 Hz to 7200 Hz • 25p mode 25.0 Hz to 7200 Hz 	
			ELC Limit (When [Shutter Mode] is set to [ELC])	---	1/2000	1/250	1/2000	1/100, 1/120, 1/250, 1/500, 1/1000, 1/2000	
		Brightness 2/3	Gain	---	Auto	Auto	0dB	(When [Super Gain] is set to [On]) Auto, 0dB to 42dB (step: 1dB) (When [Super Gain] is set to [Off]) Auto, 0dB to 36dB (step: 1dB)	
			Super Gain	---	Off	On	Off	Off, On	
			AGC Max Gain	---	24dB	36dB	24dB	6dB, 12dB, 18dB, 24dB, 30dB, 36dB	
			Frame Mix	---	Auto	Auto	Off	Auto, Off, 6dB, 12dB, 18dB, 24dB	
			Auto F.Mix Max Gain	6dB	6dB	18dB	0dB	0dB, 6dB, 12dB, 18dB	
			Backlight COMP.	Off				Off, On	
			Spotlight COMP.	Off				Off, On	
			Flicker Suppression	Off				Off, On	
		Brightness 3/3	ND Filter	Through				Through, 1/4, 1/16, 1/64, Auto	
			Day/Night	Day				Day, Night	

Camera menu item table (continued)

Camera menu			Item	Factory setting				Selection items	
Top Menu	Camera	Scene	(The factory settings differ for each Scene mode)	In [Full Auto] mode	In [Scene1] mode	In [Scene2] mode	In [Scene3] mode		
Top Menu	Camera	Scene	Picture	Picture 1/3	White Balance Mode	ATW		AWB A	ATW, AWB A, AWB B, 3200K, 5600K, VAR
					Color Temperature	3200K			2000K to 15000K
					R Gain	0			-200 to +200
					B Gain	0			-200 to +200
					AWB Color TEMP. Info	3200K			2000K to 15000K
					AWB Gain Offset	Off			Off, On
					ATW Speed	Normal			Normal, Slow, Fast
					ATW Target R	0			-10 to +10
					ATW Target B	0			-10 to +10
					Picture 2/3	Chroma Level	0%		
			Chroma Phase	0			-31 to +31		
			Master Pedestal	0			-200 to +200 (step: 1)		
			Detail	On			Off, On		
			Master Detail	0			-31 to +31		
			Detail Coring	15			0 to 60		
			V Detail Level	0			-7 to +7		
			Skin Detail	Off			Off, On		
			Picture 3/3	Gamma Mode	---	(Normal)	Normal		Normal, HD, Cinema1, Cinema2, Still Like
				Gamma	---	(0.45)	0.45		0.30 to 0.75 (step: 0.01)
				DRS	---	(Off)	Off		Off, Low, Mid, High
				Knee Mode	---	(Auto)	Auto		Off, Auto, Low, Mid, High
				White Clip	On			Off, On	
				White Clip Level	109%			90% to 109% (step: 1%)	
				DNR	Low			Off, Low, High	

Camera menu item table (continued)

Camera menu			Item	Factory setting				Selection items		
Top Menu	Camera	Scene	(The factory settings differ for each Scene mode)		In [Full Auto] mode	In [Scene1] mode	In [Scene2] mode	In [Scene3] mode		
			Matrix	Matrix 1/5	Matrix Type	Normal			Normal, Professional, User	
					Adaptive Matrix	Off			Off, On	
			Matrix 2/5	[Linear Matrix]						
				R-G	0			-63 to +63		
				R-B	0			-63 to +63		
				G-R	0			-63 to +63		
				G-B	0			-63 to +63		
				B-R	0			-63 to +63		
				B-G	0			-63 to +63		
			Matrix 3/5	[Color Correction 1/3]						
				B_Mg Saturation	0			-63 to +63		
				B_Mg Phase	0			-63 to +63		
				Mg Saturation	0			-63 to +63		
				Mg Phase	0			-63 to +63		
				Mg_R Saturation	0			-63 to +63		
				Mg_R Phase	0			-63 to +63		
				Mg_R_R Saturation	0			-63 to +63		
				Mg_R_R Phase	0			-63 to +63		
				R Saturation	0			-63 to +63		
				R Phase	0			-63 to +63		
				R_R_YI Saturation	0			-63 to +63		
				R_R_YI Phase	0			-63 to +63		
			Matrix 4/5	[Color Correction 2/3]						
				R_YI Saturation	0			-63 to +63		
				R_YI Phase	0			-63 to +63		
				R_YI_YI Saturation	0			-63 to +63		
				R_YI_YI Phase	0			-63 to +63		
				YI Saturation	0			-63 to +63		
				YI Phase	0			-63 to +63		
				YI_YI_G Saturation	0			-63 to +63		
				YI_YI_G Phase	0			-63 to +63		
				YI_G Saturation	0			-63 to +63		
				YI_G Phase	0			-63 to +63		
				G Saturation	0			-63 to +63		
				G Phase	0			-63 to +63		
			Matrix 5/5	[Color Correction 3/3]						
				G_Cy Saturation	0			-63 to +63		
				G_Cy Phase	0			-63 to +63		
				Cy Saturation	0			-63 to +63		
				Cy Phase	0			-63 to +63		
				Cy_B Saturation	0			-63 to +63		
				Cy_B Phase	0			-63 to +63		
				B Saturation	0			-63 to +63		
				B Phase	0			-63 to +63		
			Lens			Focus Mode	Auto			Auto, Manual
						AF Sensitivity	Normal			Normal, Stable
						Zoom Mode	Opt.Zoom			Opt.Zoom, i.Zoom, D.Zoom
						Max Digital Zoom	x10			x2 to x10 (step: 1)
						Digital Extender	Off			Off, x1.4, x2.0
						O.I.S. Mode	Off			Off, O.I.S.(STABLE), O.I.S.(PAN/TILT)

Camera menu item table (continued)

Camera menu		Item	Factory setting	Selection items		
Top Menu	System	System 1/2	Frequency	AW-UE80WP/AW-UE80KP: 59.94Hz AW-UE80WE/AW-UE80KE/ AW-UE80WED/AW-UE80KED: 50Hz	59.94Hz, 50Hz, 24Hz, 23.98Hz	
			Format	AW-UE80WP/AW-UE80KP: 2160/59.94p AW-UE80WE/AW-UE80KE/ AW-UE80WED/AW-UE80KED: 2160/50p	(When [Frequency] is set to [59.94Hz]) 2160/59.94p, 2160/29.97p, 1080/59.94p, 1080/59.94i, 1080/29.97p, 1080/29.97PsF, 1080/23.98p(59.94i)* ¹ , 720/59.94p (When [Frequency] is set to [50Hz]) 2160/50p, 2160/25p, 1080/50p, 1080/50i, 1080/25p, 1080/25PsF, 720/50p (When [Frequency] is set to [24Hz]) 2160/24p, 1080/24p (When [Frequency] is set to [23.98Hz]) 2160/23.98p, 1080/23.98p, 1080/23.98PsF	
			Genlock			
			Horizontal Phase	0	-206 to +49	
			Tracking Data Output			
			Serial	Off	Off, On	
		IP	Off	Off, On		
		Invert Pan/Tilt Axis	Off	Off, On		
		System 2/2	Wireless Control	Enable	Enable, Disable	
			Fan	Mid	Auto, Low, Mid, High	

*¹ It denotes "1080/23.98p over 59.94i".

Camera menu item table (continued)

Camera menu		Item	Factory setting	Selection items	
Top Menu	Output	Output 1/5	3G SDI		
		Format	AW-UE80WP/AW-UE80KP: 1080/59.94p AW-UE80WE/AW-UE80KE/ AW-UE80WED/AW-UE80KED: 1080/50p	[System Format] 2160/59.94p 2160/29.97p 1080/59.94p 1080/59.94i 1080/29.97p 1080/29.97PsF 1080/23.98p(59.94i)*1 720/59.94p 2160/50p 2160/25p 1080/50p 1080/50i 1080/25p 1080/25PsF 720/50p 2160/24p 1080/24p 2160/23.98p 1080/23.98p 1080/23.98PsF	[3G SDI] 1080/59.94p 1080/59.94i 1080/29.97p 1080/59.94p 1080/59.94i 1080/29.97p 1080/29.97PsF 1080/23.98p(59.94i)*1 720/59.94p 1080/50p 1080/50i 1080/25p 1080/50p 1080/50i 1080/25p 1080/25PsF 720/50p 1080/24p 1080/24p 1080/23.98p 1080/23.98p 1080/23.98PsF
		3G SDI Out	LevelA	LevelA, LevelB	
		HDMI			
		Format	AW-UE80WP/AW-UE80KP: 2160/59.94p AW-UE80WE/AW-UE80KE/ AW-UE80WED/AW-UE80KED: 2160/50p	[System Format] 2160/59.94p 2160/29.97p 1080/59.94p 1080/59.94i 1080/29.97p 1080/29.97PsF 1080/23.98p(59.94i)*1 720/59.94p 2160/50p 2160/25p 1080/50p 1080/50i 1080/25p 1080/25PsF 720/50p 2160/24p 1080/24p 2160/23.98p 1080/23.98p 1080/23.98PsF	[HDMI] 2160/59.94p 1080/59.94p 2160/29.97p 1080/29.97p 1080/59.94p 1080/59.94i 1080/29.97p 1080/29.97p 1080/23.98p(59.94p)*2 720/59.94p 2160/50p 1080/50p 1080/25p 1080/25p 1080/50p 1080/50i 1080/25p 1080/25p 720/50p 2160/24p 1080/24p 1080/24p 2160/23.98p 1080/23.98p 1080/23.98p 1080/23.98p
		Video Sampling	4:2:2/10bit	4:2:2/10bit, 4:2:0/8bit	

*1 It denotes "1080/23.98p over 59.94i".

*2 It denotes "1080/23.98p over 59.94p".

Camera menu item table (continued)

Camera menu		Item	Factory setting	Selection items	
Top Menu	Output	Output 2/5	Bar	Camera	Camera, Colorbar
			Color Bar Type	Type2	Type1, Type2
			Tone	Normal	Off, Low, Normal
			Audio	Off	Off, On
			Input Type	Line	Mic, Line
			Volume Level CH1	0dB	-36dB to +12dB (step: 3dB)
			Volume Level CH2	0dB	-36dB to +12dB (step: 3dB)
		Plugin Power	Off	Off, On	
		Output 3/5	OSD Mix		
			3G SDI	On	Off, On
			HDMI	On	Off, On
			NDI	On	Off, On
			IP/NDI HX	On	Off, On
		Output 4/5	OSD Off With R-Tally	Off	Off, On
			OSD Status	Off	Off, On
			Tally	Enable	Enable, Disable
			Tally LED Limit		
			R	Unlimit	Limit, Unlimit
			G	Unlimit	Limit, Unlimit
			Tally Brightness	Low	Low, Mid, High
		Output 5/5	Status Lamp	Enable	Enable, Disable
			External Output		
			Output1	Off	Off, R-Tally, G-Tally
			Output2	Off	Off, R-Tally, G-Tally
			Install Position	Desktop	Desktop, Hanging
			P/T Speed Mode	Normal(60deg/s)	Normal(60deg/s), Fast1(90deg/s), Fast2(180deg/s)
			P/T Acceleration Setting		
		P/T Acceleration	Auto	Manual, Auto	
	Rise S-Curve	15	0 to 30		
	Fall S-Curve	15	0 to 30		
	Rise Acceleration	128	1 to 255		
	Fall Acceleration	128	1 to 255		
	Speed With Zoom Position	On	Off, On		
	Focus Adjust With PTZ.	Off	Off, On		
Privacy Mode	Off	Off, On			
Power On Position	Standby	Standby, Home, Preset			
Preset Number	001	001 to 100			
Pan/Tilt					

Camera menu item table (continued)

Camera menu			Item	Factory setting	Selection items			
Top Menu	Preset	Preset 1/2	Preset Speed Unit	Speed Table	Speed Table, Time			
			Preset Speed Table	Fast	Slow, Fast			
			Preset Speed (When [Preset Speed Unit] is set to [Speed Table])	20	1 to 30			
			Preset Speed (When [Preset Speed Unit] is set to [Time])	20s	1s to 99s			
			Preset Acceleration Setting					
			Preset Acceleration	Auto	Manual, Auto			
			Rise S-Curve	15	0 to 30			
			Fall S-Curve	15	0 to 30			
			Rise Acceleration	128	1 to 255			
			Fall Acceleration	128	1 to 255			
			Rise Ramp Time	0.1s	0.1s to 10.0s			
			Fall Ramp Time	0.1s	0.1s to 10.0s			
			Preset Scope	Mode A	Mode A, Mode B, Mode C			
			Preset Digital Extender	Off	Off, On			
			Preset Thumbnail Update	On	Off, On			
			Preset Name	Reset	Reset, Hold			
			Preset 2/2	Preset Iris	Off	Off, On		
	Preset Shutter	On		Off, On				
	Preset Zoom Mode	Mode A		Mode A, Mode B				
	Freeze During Preset	Off		Off, On				
	Maintenance	Firmware Version	Firmware Version 1/2	System Version	Version at shipping	- - -		
				CPU Software				
				Main/Network	Version at shipping	- - -		
Camera				Version at shipping	- - -			
Lens				Version at shipping	- - -			
Servo			Version at shipping	- - -				
Firmware Version 2/2			EEPROM					
			Main/Network	Version at shipping	- - -			
			FPGA					
			Network	Version at shipping	- - -			
IP Network			IP Address			192.168.0.10	- - -	
			Subnet Mask			255.255.255.0	- - -	
			Default Gateway			192.168.0.1	- - -	
Scene Copy			From			Scene1	Full Auto, Scene1, Scene2, Scene3	
		To			Scene1	Full Auto, Scene1, Scene2, Scene3		
Initialize		All			- - -	CANCEL, OK		
		Scene All			- - -	CANCEL, OK		
		Full Auto			- - -	CANCEL, OK		
		Scene1			- - -	CANCEL, OK		
		Scene2			- - -	CANCEL, OK		
		Scene3			- - -	CANCEL, OK		
Hour Meter		Operation			00000000	- - -		
		Fan			00000000	- - -		
HDMI Status		Connect			- - -	- - -		
		Format			- - -	- - -		
		Video Sampling			- - -	- - -		
		Monitor			- - -	- - -		
Error Status		Lens			No Error	No Error, Error		
		Pan/Tilt			No Error	No Error, Error		
	Fan			No Error	No Error, Error			
	Temperature			No Error	No Error, High Temperature, Sensor Error			

Displaying the web screen

With a personal computer connected to the unit, it is possible to view the camera's IP videos or select various settings from the web browser.

The LAN crossover cable is used when connecting a personal computer directly to the unit's LAN connector for IP control, and the LAN straight cable is used when making the connection through a switching hub.

Select an IP address for the personal computer within the private address range while ensuring that it is different from the address of the unit. Set the subnet mask to the same address as the unit.

<NOTE>

- If you need to change the IP address and subnet mask, be sure to ask your dealer to make these changes for you.

Unit's IP address and subnet mask (factory settings)*1

IP address: 192.168.0.10
 Subnet mask: 255.255.255.0

*1 The factory default for the private address range is between 192.168.0.1 and 192.168.0.255.

- If the controller and web browser are being used at the same time, the content selected using the controller may not be reflected on the web browser display. When using both the controller and web browser, be absolutely sure to check the settings using the controller or camera menu.

For details of the required personal computer environment, refer to page 8.

<NOTE>

- Some functions on the web setting screen can be used only from Windows Internet Explorer 11. Functions which can be used by Windows Internet Explorer 11 only are indicated using the **Windows I.E.11** mark.
- The "Network Camera View 4S" plug-in viewer software must have already been installed in order to display the unit's IP videos using Windows Internet Explorer 11. This is not necessary when using web browsers other than Windows Internet Explorer 11. For details, refer to "Installing the plug-in viewer software" (→ page 29).
- When [IP(UDP)] of [Tracking Data Output] is set to [On] and opening the web screen, a warning message will be displayed. Click the [Continue] button to leave the web screen open.
- While the web screen is displayed, the tracking data that is output when [IP(UDP)] of [Tracking Data Output] is [On] may be delayed or the data value may not be updated. (→ page 122)

Displaying the web screen using a personal computer

The procedure is explained here using Windows screens (Internet Explorer). When using other browsers, some screen displays will be different, but the procedure is similar.

1. Start the web browser of the personal computer.

Use one of the web browsers below depending on the operating system installed in the personal computer.

Operating system installed	Web browser
Windows	Windows 10/Internet Explorer 11 Windows 10/Microsoft Edge Windows 10/Google Chrome
macOS	macOS v11.0.1/Safari 14.01 macOS v11.0.1/Google Chrome macOS v10.15/Google Chrome macOS v10.14/Google Chrome

2. Enter the IP address you configured on the Easy IP Setup Software in the address bar of the web browser.

IPv4 address entry example:

http://[URL registered with IPv4 address]
 http://192.168.0.10/

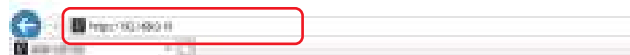

IPv6 address entry example:

http://[URL registered with IPv6 address]
 http://[2001:db8::10]/

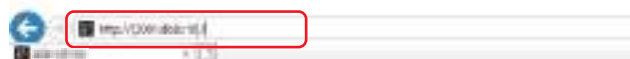

<NOTE>

- If the HTTP port number has been changed from "80", enter "http://<camera IP address>:<port number>" in the address bar. Example: When the port number is set to 8080: http://192.168.0.10:8080
- If the unit is located on the local network, configure proxy server settings on the web browser ([Tools] - [Internet Options] in the menu bar) so that a proxy server is not used for the local address.
- For details on when [HTTPS] - [Connection] (→ page 132) is set to [HTTPS] in the [Advanced] of the network setup screen [Network], see "Accessing the Camera by HTTPS" (→ page 140).

Displaying the web screen (continued)

3. Set the initial account.

In the initial state, the initial account setting screen is displayed when the web screen is displayed.

Set a user name and password.

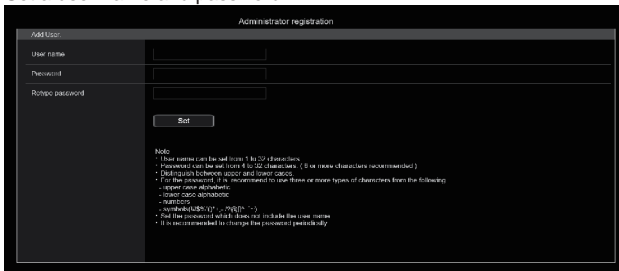

<NOTE>

- Do not set character strings that can be easily guessed by third parties.
- Change the password at regular intervals.
- The password must use at least 3 of the following 4 character types and be 8 characters or longer.
 - Alphabet upper cases
 - Alphabet lower cases
 - Numerals
 - Symbols (! # \$ % ' () * + , - . / ? @ [] ^ _ ` ~)
- When a password is set that does not adhere to the above policy, take responsibility for use of the device with due consideration for the security risks in the installation environment, etc.
- A warning is displayed if the set password goes against the recommended setting policy. When changing the password, click the [Back] button and set the password again. When continuing with the setting with full understanding of the security risks, click [Continue] to complete the setting.
- If you forget the account information that was set, use the switches for initialization of service switches to reset the user information used for connecting to the network. (→ page 18)

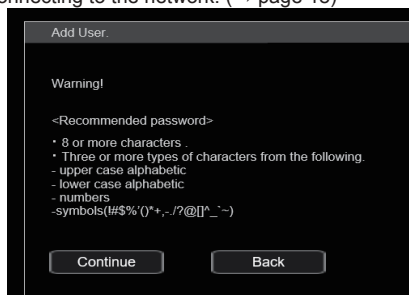

4. Completing registration of the initial account

After completing registration of the initial account, the following registration completed screen is displayed.

The live screen [Live] is automatically displayed after about 10 seconds elapse after the completed screen is displayed.

If the live screen [Live] is not displayed after 10 seconds elapse, manually move to the live screen [Live] by clicking the “please click here” link.

This completes the process of registering the initial account.

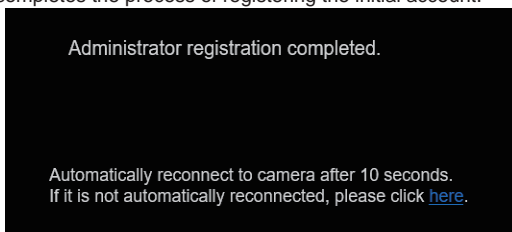

<NOTE>

- Network connection with AW-RP150 or AW-RP60 requires setup of an initial account. (→ page 28)
When an initial account is not set up, AW-RP150 or AW-RP60 can detect but cannot control this unit.

5. Display the live screen [Live].

The web screen appears.



The live screen [Live] (→ page 86) is displayed initially. You can switch to the web setup screen [Setup] (→ page 91) when necessary. (→ page 85)





<NOTE>

- If the personal computer does not have the plug-in viewer software already installed, an installation confirmation message is displayed before the live screen [Live] is displayed. In a case like this, follow the on-screen instructions to install the software. [Windows I.E.11](#)
For details, refer to “Installing the plug-in viewer software” (→ page 29).
- Depending on the firewall settings on your personal computer, transmitted images may not be displayed. If this occurs, change the firewall settings and change the settings to permit communications with your web browser.
- When an attempt is made to display multiple IP images on one personal computer, IP videos may not be displayed depending on the performance of the personal computer concerned.
A maximum of 14 users, including users receiving IP video, can access the unit simultaneously. However, the number of users that can access the unit may be restricted to less than 14 depending on the network communication bandwidth used by the unit. A message indicating the access limit will appear if the number of users exceeds 14. When [Transmission type] is set to [Multicast port] for [H.264] or [H.265], the second and subsequent users receiving H.264 or H.265 images will not be counted toward the total access count.
- When [H.264 transmission] (→ page 102) is set to [On], H.264 images are displayed. When it is set to [Off], JPEG images will be displayed. JPEG images can be displayed even when [H.264 transmission] is set to [On]. [Windows I.E.11](#)
- The JPEG image frame rate may be slower depending on the network environment, performance of your personal computer, subject of the video, and access volume.

Switching between the Live screen [Live] and Web setup screen [Setup]

When the live screen [Live]  is displayed, click the [Setup] button  at the top of the live screen [Live].

For details on the web setup screen [Setup], see “Web setup screen [Setup]” (→ page 91).

When the web setup screen [Setup]  is displayed, click the [Live] button  at the top of the web setup screen [Setup].

For details on the live screen [Live], see “Live screen [Live]” (→ page 86).

<NOTE>

- During Standby mode, the [Setup] button is disabled, and you cannot switch to the web setup screen [Setup].
- If the unit is switched to Standby mode from another terminal while the web setup screen [Setup] is displayed, the display will switch to the live screen [Live] after a few seconds.

Logging into the Web screen

When user authentication is enabled

When displaying the live screen [Live]

You need to enter account information for a user with Camera control or Administrator privileges.

When displaying the web setup screen [Setup]

You need to enter account information for a user with Administrator privileges.

When user authentication is disabled

When displaying the live screen [Live]

It is not necessary to enter account information.

When displaying the web setup screen [Setup]

You need to enter account information for a user with Administrator privileges.

<NOTE>

- The account input screen is displayed in a pop up screen from your web browser.
- Correctly enter the user name and password that has already been registered.
- It is recommended that the password be changed at regular intervals.
- During Standby mode, the [Setup] button is disabled, and you cannot switch to the web setup screen [Setup].

Web screen operations

Live screen [Live]

You can display images from the camera on a personal computer and perform camera operations, such as pan, tilt, zoom, and focus control. The items displayed on the screen will differ depending on whether the [H.264] or [JPEG] button is selected under [Compression].

When [H.264] is selected Windows I.E.11



Operation screen display buttons (for touch panels)

Displays screen with larger operation buttons for touch panels. For details, refer to "Displaying the web screen using a personal computer equipped with a touch panel" (→ page 147).



Expansion panel display button (→ page 89, page 90)

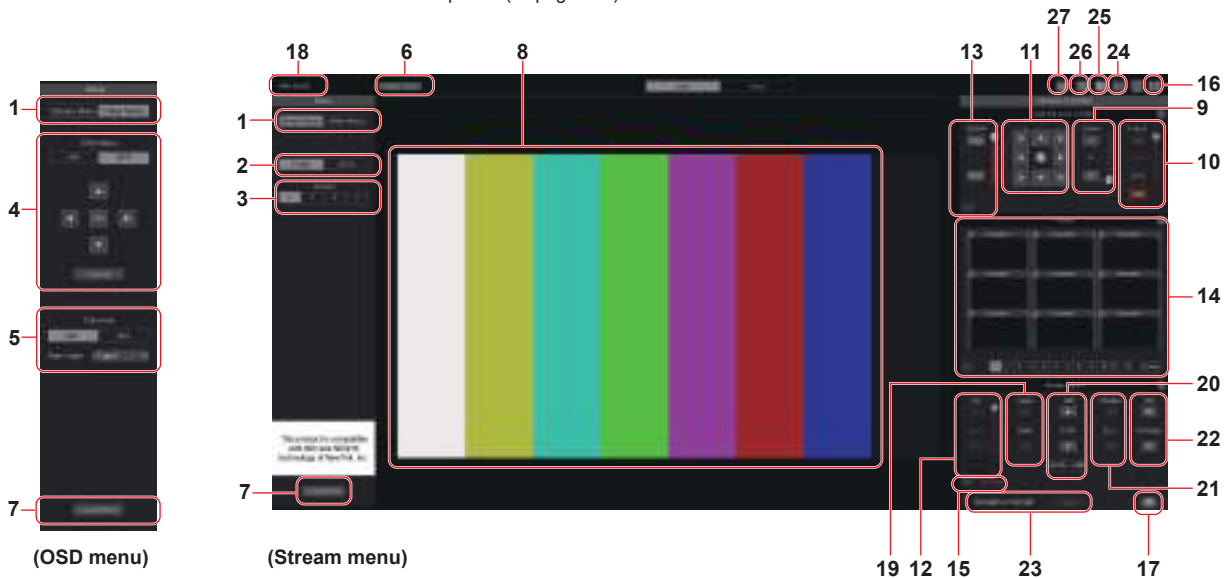

When [JPEG] is selected



Operation screen display buttons (for touch panels)

Displays screen with larger operation buttons for touch panels. For details, refer to "Displaying the web screen using a personal computer equipped with a touch panel" (→ page 147).



Expansion panel display button (→ page 89, page 90)

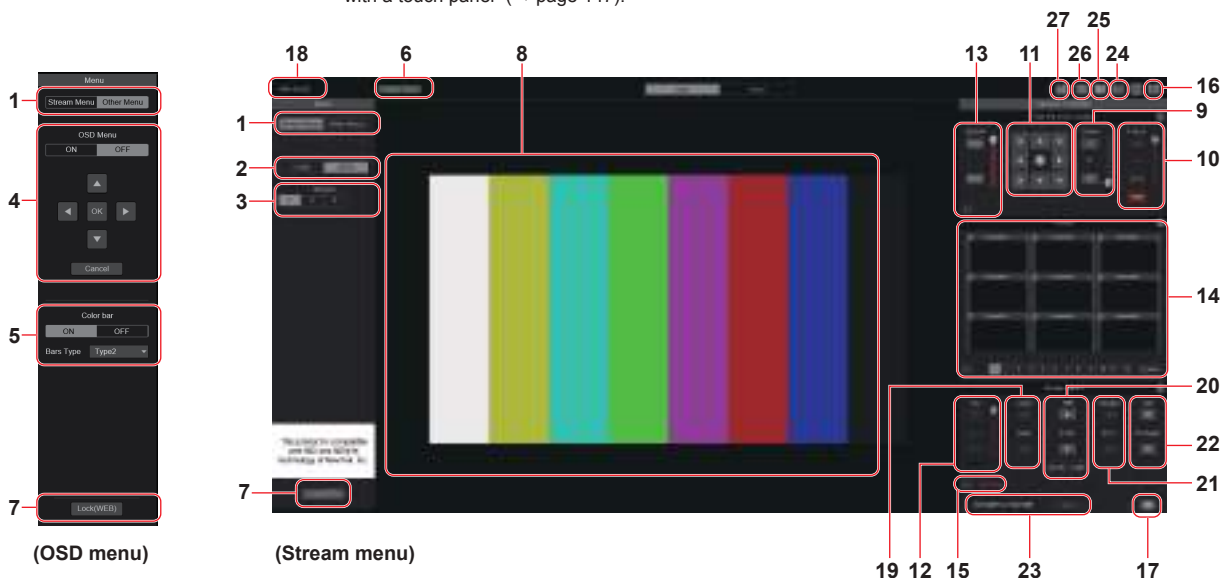



1. Menu switching [Stream Menu]/[Other Menu]

Switch between menu displays.

Clicking [Other Menu] when the Stream menu is displayed displays the Other menu.

Clicking [Stream Menu] when the Other menu is displayed displays the Stream menu.

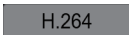
2. Compression button [Compression]

 [H.264]	The [H.264] button turns gray, and H.264 images are displayed. Windows I.E. 11 The [H.264] button is enabled when the [H.264 transmission] setting of [H.264(1)] to [H.264(4)] on the Video over IP is [On]. (→ page 102)
 [JPEG]	The [JPEG] button turns gray, and JPEG images are displayed.

<NOTE>





- In the following cases, the selection status of the [Compression] buttons will return to the setting configured in the [Video over IP] - [Initial display setting] - [Stream] (→ page 101).
 - When returning from another screen
 - When the screen is updated

3. Stream buttons [Stream]

When H.264 is selected

These buttons appear only when H.264 images are displayed.

[Windows I.E. 11](#)



 [1]	When selected, the button turns gray, and the images in the main area appear according to the settings configured for [H.264(1)]. (→ page 102)
 [2]	When selected, the button turns gray, and the images in the main area appear according to the settings configured for [H.264(2)]. (→ page 102)
 [3]	When selected, the button turns gray, and the images in the main area appear according to the settings configured for [H.264(3)]. (→ page 102)
 [4]	When selected, the button turns gray, and the images in the main area appear according to the settings configured for [H.264(4)]. (→ page 102)

<NOTE>

- In the following cases, the selection status of the [Stream] buttons will return to the setting configured in the [Video over IP] - [Initial display setting] - [Stream] (→ page 101).
 - When returning from another screen
 - When the screen is updated
- If the H.264 image resolution is set to [1920x1080] or [1280x720], the image may be compressed depending on the size of the web browser window.

When JPEG is selected



These buttons appear only when JPEG images are displayed.

 [1]	When selected, the button turns gray, and the images in the main area appear according to the settings configured for [JPEG(1)]. (→ page 101)
 [2]	When selected, the button turns gray, and the images in the main area appear according to the settings configured for [JPEG(2)]. (→ page 101)
 [3]	When selected, the button turns gray, and the images in the main area appear according to the settings configured for [JPEG(3)]. (→ page 101)



<NOTE>

- The resolution selected with [JPEG(1)], [JPEG(2)], and [JPEG(3)] (→ page 101) under [JPEG] in the [Video over IP] will be used.
- If the resolution is set to [1920x1080] or [1280x720], the image may be compressed depending on the size of the web browser window.
- In the following cases, the selection status of the [Image Capture Size] buttons will return to the setting configured in the [Video over IP] - [Initial display setting] - [Stream] (→ page 101).
 - When returning from another screen
 - When the screen is updated

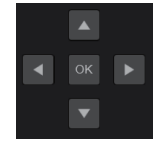

4. OSD Menu Operation [OSD Menu]

 [ON] [OFF]	Use this to select whether the camera's on-screen displays are to be shown.
 [Cancel]	It cancels the selection of the setting which is being changed. It restores the pre-change setting.
 [▲] [▼] [◀] [▶] [OK]	Use these to perform the menu operations. The items are selected using the [▲][▼][◀][▶] buttons. If a selected item has a sub menu, this sub menu is displayed by pressing the [OK] button. When the cursor is moved to any item on the bottom-level setting screen and the [OK] button is pressed, the setting of the selected item starts flashing. A setting for a regular menu item is reflected immediately if it is changed while it is still flashing. However, there are a number of menu items whose setting is reflected only after the [OK] button has been pressed, causing the setting to stop flashing and the new setting to be entered.

5. Color bar button [Color bar]

 [ON] [OFF]	Switch the color bar signal displayed or hide.
 [Type1] [Type2]	Switch the color bar displayed between Type1 and Type2. This is only enabled when [Color bar] is set to [ON].

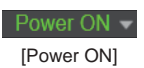
6. Power ON button [Power ON]/Standby button [Standby]

 [Power ON]	Turn the unit on.
 [Standby]	Set the unit to Standby mode.

In the Standby mode, all the buttons on the live screen [Live] except for the [Power ON] button and [Standby] button are disabled.

<NOTE>

- If [Power ON] or [Standby] is selected too quickly, the status selected and the display shown may not correspond. In a case like this, follow the steps below to restore the correct status display:

For Windows:

Press the [F5] key on the keyboard of the personal computer.

For Mac:

Press the [Command] + [R] keys on the keyboard of the personal computer.

• **When operation is transferred to the Standby mode:**

The current Pan/Tilt/Zoom positions are stored. When [Standby] is selected in the [Power ON Position] menu, the information about the stored positions is used.

• **When operation is transferred to the Power ON mode:**

Pan/Tilt/Zoom are moved to the positions selected in the [Power ON Position] menu.

7. Operation lock button [Lock]

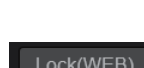
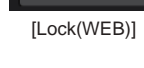
 [Lock(WEB)]	This prevents erroneous operation by locking operations such as pan/tilt, zoom, focus, iris, gain, white balance, shutter, ND filter, and preset in the live screen [Live]. The button turns red while locked, and the lock is released when the button is clicked again.
 [Lock(CAM)]	This is displayed when the unit is locked with the camera lock function on a Panasonic controller (AW-RP150, AW-RP60), and you can unlock the camera by clicking this.

<NOTE>

- When locked using a [Lock(WEB)] function, the status is maintained by the web browser, so the lock is released by redisplaying the web browser.
- The lock status using the [Lock(CAM)] function is maintained by the camera itself, so you need to either release the camera lock function using a Panasonic controller (AW-RP150, AW-RP60) or release [Lock(CAM)] from the web browser while the camera is locked.
- It is not possible to enable the [Lock(CAM)] function from the web browser.

8. Main area (IP video display area)

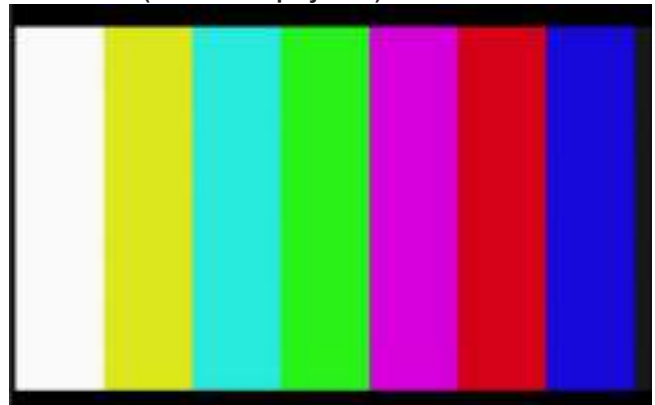

The IP video of the connected camera will be displayed.

When the tally lamp of the camera is on, a red and a green lines are displayed at the top of the videos. A red line is displayed when receiving the red tally signal and a green line is displayed when receiving the green tally signal.

When the tally lamp is off, the display area will return to normal.



When you click inside the area, the camera moves so the clicked position becomes the center of the area.

Operating the mouse wheel inside the display area allows you to use the plug-in viewer software's digital zoom. [Windows I.E.11](#)

<NOTE>

- When the shooting scenes vary significantly, restrictions imposed by the graphics processing (GDI) of the operating system installed may give rise to a phenomenon called "screen tearing" (where parts of the picture are not displayed in synchronization) although this will depend on the personal computer used.
- On Windows Internet Explorer 11, if [H.264 transmission] (→ page 102) is set to [On], H.264 images can be displayed.
- On browsers other than Windows Internet Explorer 11, regardless of the [H.264 transmission] settings, only JPEG images can be displayed. (H.264 images will not appear.)
- The speed at which the JPEG images are refreshed may be reduced depending on the network environment, performance of the personal computer used, subjects and number of access users.
- A total of 14 users, including users receiving IP video, can access the unit simultaneously.
However, when the IP video transmission bandwidth reaches its upper limit, access may be restricted to less than 14 users.
- When [Disable] is selected for [Tally] (→ page 62, page 97), the camera's tally lamp will not light even when the tally signal is input. However, a red and a green lines are displayed at the top of the main area (IP video display area).
- The camera may not move so the clicked position becomes the center of the area when you click inside the area within a tilt range of ±15° of the vertical of the unit.
- When [IP(UDP)] of [Tracking Data Output] is set to [On], video transmission via IP may be delayed or the video may suffer frame loss. (→ page 122)
We recommend setting [IP(UDP)] of [Tracking Data Output] to [Off] to avoid the delay or frame loss due to the video transmission via IP.

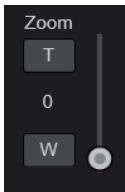

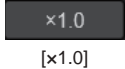
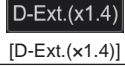
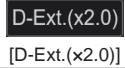
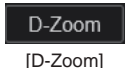

9. Zoom [Zoom]

	[T]: Use this to adjust the zoom (magnification) in the "Tele" direction. [W]: Use this to adjust the zoom (magnification) in the "Wide" direction. The optical zoom position is displayed in the center as a value. Value range: 000 (Wide end) to 999 (optical Tele end)
	Display button for PTZ expansion panel The [D-Zoom], [D-Ext.(x1.4)], [D-Ext.(x2.0)], and [x1.0] buttons for zoom and [O.T.AF] and [Touch AF] buttons for focus (→ page 89) are displayed. The display changes to [-] while these are displayed, and they stop being displayed when this is pressed again.
	Use this to adjust the zoom (magnification) to 1.0x.
	Use this to enable or disable digital extender x1.4.
	Use this to enable or disable digital extender x2.0.
	Use this to enable or disable the digital zoom.

<NOTE>

- The values indicating the optical zoom position do not change while zoom is still being operated within the digital zoom region.
- When digital zoom is enabled, it is possible to zoom in with the digital zoom by clicking the [T] button, even if the optical zoom position is optical Tele end 999.
- The [D-Zoom], [D-Ext.(x1.4)], [D-Ext.(x2.0)] and [x1.0] buttons are not displayed immediately after the live screen [Live] is displayed. They are displayed when the [Display button for PTZ expansion panel] is pressed.

10.Focus [Focus]

	[Far]: Use this to adjust the focus in the "Far" direction. It does not work during automatic adjustments. [Near]: Use this to adjust the focus in the "Near" direction. It does not work during automatic adjustments. The focal distance is displayed in the center as a value. Value range: 00 (Near) to 99 (Far)
	Use this to switch between auto and manual focusing. When Auto is selected, the focus is adjusted automatically.
	When this is pressed while the focus is being adjusted manually, the focus will be adjusted automatically once only. It does not work during automatic adjustments. It is displayed when the [Display button for PTZ expansion panel] (→ page 89) is pressed.
	When this is pressed while the focus is being adjusted manually, the focus will be adjusted automatically in the area touched. It does not work during automatic adjustments. It is displayed when the [Display button for PTZ expansion panel] (→ page 89) is pressed.



<NOTE>

- The [O.T.AF] and [Touch AF] buttons are not displayed immediately after the live screen [Live] is displayed. They are displayed when the [Display button for PTZ expansion panel] is pressed.

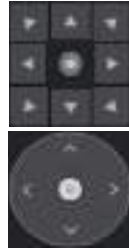
11.Control pad and its buttons

	To adjust the image in the horizontal or vertical direction (panning or tilting), left-click the pad and the buttons. It is possible to operate with the central grid pattern in the dragged state, with the speed of the pan/tilt increasing as it approaches the outside of the pad.
--	---







12.Brightness [Iris]

	[+]: Operates in stages in the direction of iris opening. It does not work during automatic adjustments. [-]: Operates in stages in the direction of iris closing. It does not work during automatic adjustments. The F value is displayed in the center.
	Use this to switch the iris adjustment between auto and manual. When Auto is selected, the picture brightness is adjusted automatically.

13.Speed [Speed]

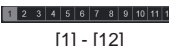
	Use this to select the speed at which the pan, tilt, zoom, and focus operations are to be performed. The speed of pan/tilt operation is reflected in control pad operations. It is not reflected in grip button operations.
--	--

14.Preset [Preset]

	When a preset thumbnail is clicked, the camera moves to face towards a preset position that was registered beforehand. You can select Home and Preset1 to Preset100. Preset numbers are displayed in green when they have had a preset position registered in them.
	Preset names are displayed. During the preset registration mode, you can select a preset name and change the display name. You can enter between 1 to 15 characters. The characters available are 0 to 9, A to Z, a to z, spaces, and underscores (_).
	Switches the page of the displayed preset thumbnails.
	Move to home position.
	Display button for preset expansion panel The [SET] and [DEL] buttons for presetting are displayed. The display changes to [-] while these are displayed, and they stop being displayed when this is pressed again.
	The unit moves to the preset registration mode. When a preset thumbnail is clicked in the preset registration mode, it is registered in the preset position specified by the current condition.
	The unit moves to the preset delete mode. When a preset thumbnail is clicked in the preset delete mode, the specified preset position settings are deleted.

<NOTE>

- If the [Preset Thumbnail Update] menu is [Off] when registering presets, the previously registered preset thumbnail is maintained.
- If the [Preset Name] menu is [Reset] when registering presets, the previously registered preset name is reset.
- The [SET] and [DEL] buttons are not displayed immediately after the live screen [Live] is displayed. They are displayed when the [Display button for preset expansion panel] is pressed.

15.Scene [Scene]

	Click Full Auto, Scene1-Scene3 to switch the shooting mode.
	Display button for scene expansion panel The [Full Auto], [Scene1], [Scene2] and [Scene3] buttons for scene files are displayed. The display changes to [-] while these are displayed, and they stop being displayed when this is pressed again.

<NOTE>

- The [Full Auto], [Scene1], [Scene2] and [Scene3] buttons are not displayed immediately after the live screen [Live] is displayed. They are displayed when the [Display button for scene expansion panel] is pressed.

16.Full-screen display button

	Display the image in full-screen mode. To return to the live screen [Live], press the [Esc] key on the personal computer while the image is displayed in full-screen mode. The aspect ratio of the displayed image will be adjusted according to the monitor size.
--	--

17.Snapshot button

	Capture a snapshot (single still image), and display it in a separate window.
--	---

<NOTE>

- The following settings may be necessary. In the Internet Explorer menu bar, click [Tools] - [Internet Options] - [Security] tab, select [Trusted Sites], and then click [Sites]. Register the camera's address under [Websites] in the window that appears.
- Depending on the network environment, for example, if snapshot capture takes longer than a certain amount of time, the image may not appear.
- If [JPEG transmission(1)] - [JPEG transmission(3)] (→ page 101) are all set to [Off], the image captured with the snapshot button will be black.

18.Camera title display area

The name for the unit configured in [Camera title] in [Live page] in the Basic screen [Basic] (→ page 99) appears.

19.Gain [Gain]

	Increase the gain of the images.
	Decrease the gain of the images.

<NOTE>

- The current setting is displayed in the middle of the button.

20.White balance [WB]

	Switch the white balance in the order [AWB A], [AWB B], [3200K], [5600K], [VAR], [ATW].
	Switch the white balance in the order [AWB A], [ATW], [VAR], [5600K], [3200K], [AWB B].
	Automatic white balance (AWB) is executed and the white balance is reset.
	Automatic black balance (ABB) is executed and the black balance is reset.

<NOTE>

- The current setting is displayed in the middle of the button.

21.Shutter [Shutter]

	Switch the shutter mode in the order [Off], [Step], [Synchro], [ELC].
	Switch the shutter mode in the order [ELC], [Synchro], [Step], [Off].

<NOTE>

- The current setting is displayed in the middle of the button.

22.ND filter [ND]

	Switch the transmittance of the ND filter in the order [Through], [1/4 ND], [1/16 ND], [1/64 ND].
	Switch the transmittance of the ND filter in the order [1/64 ND], [1/16 ND], [1/4 ND], [Through].

<NOTE>

- The current setting is displayed in the middle of the button.
- ND filter switching is not possible in night mode.

23.SRT/MPEG2-TS/RTMP

	Starts streaming to the transmission destination that was pre-registered. The button turns red during transmission, and transmission stops when the button is clicked again.

<NOTE>

- This button can be used only when [Streaming mode] is [RTMP], [SRT(H.264)], [SRT(H.265)], or [MPEG2-TS over UDP].
- When [Streaming mode] is [SRT(H.264)], or [SRT(H.265)], transmission can be started by clicking this button only when the Client(Call) mode is set.

24.Button for switching the personal computer screen

	Display the screen for mobile terminals. For details, refer to "Displaying the web screen using a mobile terminal" (→ page 149).
--	--

<NOTE>

- This button is displayed only when displaying on a mobile terminal.

25.Preset thumbnail list display button

	Display a list of Preset thumbnails on the live screen [Live].
--	--

26.Button for switching real time updating

	Frame dropping in images may be observed depending on the operating performance of the personal computer running the web browser. You can improve this problem by pressing this button to disable the real time updating function. Data items subject to real time updating are as follows. - Zoom - Focus - Iris - Gain - WB - Shutter - ND
--	---

<NOTE>

- The middle-click function is disabled if the button is enabled.
- The Audio Level Meter function is disabled if the button is enabled.

27.Audio Level Meter display button

	Display the status of audio input to this unit and the audio setting status on the live screen [Live].
--	--

Web screen configurations

Web setup screen [Setup]

The settings for the unit are selected on this screen.

<NOTE>

- The setting menu operations can be performed only by users whose access level is "1.Administrator".
For the procedure used to set the access level, refer to page 125.
- If the value of a setting is changed using the OSD menu or a different web browser, the setting value and the displayed value may not match. In that case, update the setup menu display screen of that web browser.



1. Setting status [Setting status]

The setting status screen [Setting status] is displayed when the button is clicked.

→ "Setting status screen [Setting status]" (→ page 92)

2. Basic settings [Basic]

System button [System]

The system screen [System] is displayed when the button is clicked.

→ "System screen [System]" (→ page 93)

Date&Time button [Date&Time]

The Date & time screen [Date&Time] is displayed when the button is clicked.

→ "Date & time screen [Date&Time]" (→ page 99)

Live page button [Live page]

The live page screen [Live page] is displayed when the button is clicked.

→ "Live page screen [Live page]" (→ page 99)

3. Image screen [Image/Audio]

IP video settings button [Video over IP]

The IP video settings screen [Video over IP] is displayed when the button is clicked.

→ "IP video settings screen [Video over IP]" (→ page 100)

Audio button [Audio]

The audio setting screen [Audio] is displayed when the button is clicked.

→ "Audio setting screen [Audio]" (→ page 110)

Image adjust button [Image adjust]

The image adjust screen [Image adjust] is displayed when the button is clicked.

→ "Image adjust screen [Image adjust]" (→ page 111)

Lens button [Lens]

The Lens setting screen [Lens] is displayed when the button is clicked.

→ "Lens setting screen [Lens]" (→ page 118)

Preset position button [Preset position]

The preset position screen [Preset position] is displayed when the button is clicked.

→ "Preset position screen [Preset position]" (→ page 119)

Web screen configurations (continued)

4. Collaboration capability [Linkage]

Tracking data output setting button [Tracking Data Output]

The tracking data output setting screen [Tracking Data Output] is displayed when the button is clicked.

→ “Tracking data output settings screen [Tracking Data Output]”
(→ page 122)

P2 Cast connection setting button [P2 Cast]

P2 Cast connection setting screen [P2 Cast] is displayed when the button is clicked.

→ “P2 Cast connection setting screen [P2 Cast]” (→ page 124)

5. User management settings [User mng.]

User authentication button [User auth.]

The user authentication screen [User auth.] is displayed when the button is clicked.

→ “User authentication screen [User auth.]” (→ page 124)

Host authentication button [Host auth.]

The host authentication screen [Host auth.] is displayed when the button is clicked.

→ “Host authentication screen [Host auth.]” (→ page 125)

6. Network settings [Network]

Network setup button [Network]

The network setup screen [Network] is displayed when the button is clicked.

→ “Network setup screen [Network]” (→ page 126)

Advanced network setting button [Advanced]

The advanced network setting screen [Advanced] is displayed when the button is clicked.

→ “Advanced network setting screen [Advanced]” (→ page 130)

7. Maintenance [Maintenance]

System log button [System log]

The system log screen [System log] is displayed when the button is clicked.

→ “System log screen [System log]” (→ page 143)

Product information button [Product Info.]

The product information screen [Product info.] is displayed when the button is clicked.

→ “Product information screen [Product info.]” (→ page 144)

Reset settings button [Default reset]

The reset settings screen [Default reset] is displayed when the button is clicked.

→ “Reset settings screen [Default reset]” (→ page 145)

Back up button [Backup]

The back up screen [Backup] is displayed when the button is clicked.

→ “Back up screen [Backup]” (→ page 146)

8. Power ON button [Power ON]/Standby button [Standby]

Power ON ▾ [Power ON]	Turn the unit on.
Standby ▾ [Standby]	Set the unit to Standby mode.

When you enter Standby mode, the display will automatically switch to the live screen [Live]. In addition, the [Setup] button in the live screen [Live] will be disabled, and you cannot operate the web setup screen [Setup].

9. Main area

The menu screen is displayed.

Setting status screen [Setting status]



Model no.

The model number of the unit is displayed.

Firmware Version

The firmware version of the unit is displayed.

Refer to the product information screen [Product info.] for detailed version information.

System Frequency

The frame frequency of the unit is displayed.

System Format

The video format of the unit is displayed.

Streaming mode

The streaming mode of the unit is displayed.

Basic screen [Basic]

System screen [System]

System status



Frequency

The frame frequency setting is displayed.

Format

The video format setting is displayed.

Genlock

Horizontal Phase

The horizontal phase setting during genlock is displayed.

Wireless Control

The wireless remote control setting is displayed.

Fan

The setting for the cooling fan is displayed.

Output

3G SDI

The output setting for the 3G SDI OUT connector <3G SDI OUT> is displayed.

HDMI

The output setting for the HDMI connector <HDMI> is displayed.

Pan/Tilt

Install Position

The install position setting is displayed.

P/T Speed Mode

The P/T speed mode setting is displayed.

Speed With Zoom Position

The settings for the function to adjust the speed of pan/tilt adjustment are displayed in conjunction with the zoom magnification.

Focus Adjust With PTZ.

The settings for the function to compensate for poor focus when using pan/tilt/zoom are displayed.

Frequency

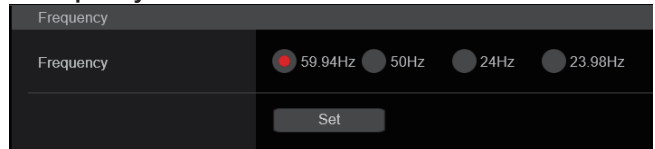

Frequency [59.94Hz, 50Hz, 24Hz, 23.98Hz]

This item is selected to switch the frame frequency. The setting is confirmed with the [Set] button.

Factory settings:

59.94Hz (AW-UE80WP/AW-UE80KP)

50Hz (AW-UE80WE/AW-UE80KE/AW-UE80WED/AW-UE80KED)

<NOTE>

- When the frame frequency is switched, the unit automatically restarts.

Format

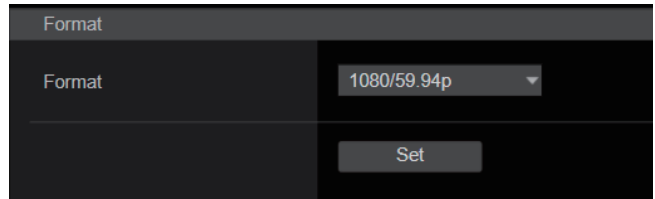

Format

For [59.94Hz]

2160/59.94p, 2160/29.97p, 1080/59.94p, 1080/59.94i, 1080/29.97p, 1080/29.97PsF, 1080/23.98p(59.94i)*1, 720/59.94p

For [50Hz]

2160/50p, 2160/25p, 1080/50p, 1080/50i, 1080/25p, 1080/25PsF, 720/50p

For [24Hz]

2160/24p, 1080/24p

For [23.98Hz]

2160/23.98p, 1080/23.98p, 1080/23.98PsF

The video format is changed on this screen. The setting is confirmed with the [Set] button.

*1 It denotes "1080/23.98p over 59.94".

Web screen configurations (continued)

● Genlock

This item is selected to perform the phase adjustments.

This item's setting is reflected immediately.

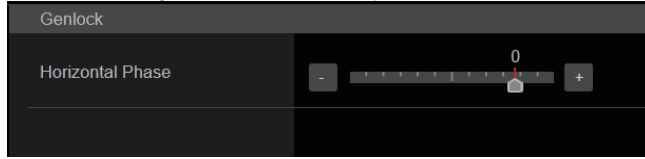

Horizontal Phase [-206 to +49]

This is used to adjust the horizontal phase during genlock.

Factory settings: 0

● Wireless Control

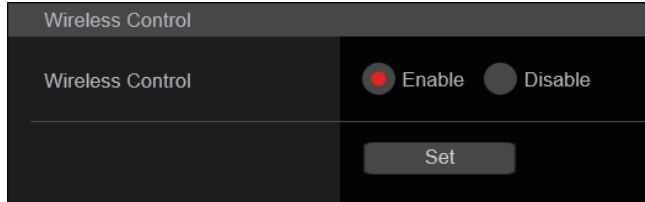

Wireless Control [Enable, Disable]

[Enable] or [Disable] is set here for operations conducted from the wireless remote control.

The setting is confirmed with the [Set] button.

Factory settings: Enable

<NOTE>

- When the power is turned on with the wireless remote control, then operations from the wireless remote control are possible irrespective of this setting value.
- This item is not reflected immediately when the setting is changed. It is reflected when the unit is set to Standby mode, and then the power is turned ON with any external device other than the wireless remote control.
- This setting is not reflected when the power is turned ON with this item set to [Enable]. It is reflected when the unit is set to Standby mode, and then the power is turned ON with any external device other than the wireless remote control.

● Fan

Set the cooling fan operation.

The setting is confirmed with the [Set] button.



<NOTE>

- Even if this is set to [Low], [Mid], or [High], the cooling fan may be forcibly stopped when the temperature is low.
- Even if this is set to [Low] or [Mid], the cooling fan may be forcibly operated at [High] when the temperature is high.

Fan [Auto, Low, Mid, High]

Set the operation of the cooling fan.

Auto	Enable automatic control of the cooling fan.
Low	Operate the cooling fan at low speed.
Mid	Operate the cooling fan at medium speed.
High	Operate the cooling fan at high speed.

Factory settings: Mid

● Output



3G SDI

Make the settings for output from the 3G SDI OUT connector.

Format

Set the output format.

The following format settings are possible depending on the [Format] setting in the [System] screen.

Frequency	System Format	Format (3G SDI)
59.94Hz	2160/59.94p	1080/59.94p 1080/59.94i
	2160/29.97p	1080/29.97p
	1080/59.94p	1080/59.94p 1080/59.94i
	1080/59.94i	1080/59.94i
	1080/29.97p	1080/29.97p
	1080/29.97PsF	1080/29.97PsF
	1080/23.98p(59.94i)*1	1080/23.98p(59.94i)*1
	720/59.94p	720/59.94p
50Hz	2160/50p	1080/50p 1080/50i
	2160/25p	1080/25p
	1080/50p	1080/50p 1080/50i
	1080/50i	1080/50i
	1080/25p	1080/25p
	1080/25PsF	1080/25PsF
	720/50p	720/50p
	720/50p	720/50p
24Hz	2160/24p	1080/24p
	1080/24p	1080/24p
23.98Hz	2160/23.98p	1080/23.98p
	1080/23.98p	1080/23.98p
	1080/23.98PsF	1080/23.98PsF

*1 It denotes "1080/23.98p over 59.94i".

Factory settings:

1080/59.94p (AW-UE80WP/AW-UE80KP)

1080/50p (AW-UE80WE/AW-UE80KE/AW-UE80WED/
AW-UE80KED)

3G SDI Out [LevelA, LevelB]

When [Format] (3G SDI) is [1080/59.94p] or [1080/50p], select the format for outputting 3G SDI signals.

LevelA	Level A format
LevelB	Level B format

Factory settings: LevelA

<NOTE>

- [3G SDI Out] cannot be changed if [Format] (3G SDI) is other than [1080/59.94p] or [1080/50p].

Web screen configurations (continued)

HDMI

Make the settings for output from the HDMI connector.

Format

Set the output format.

The following format settings are possible depending on the [Format] setting in the [System] screen.

Frequency	System Format	Format (HDMI)
59.94Hz	2160/59.94p	2160/59.94p 1080/59.94p
	2160/29.97p	2160/29.97p 1080/29.97p
	1080/59.94p	1080/59.94p
	1080/59.94i	1080/59.94i
	1080/29.97p	1080/29.97p
	1080/29.97PsF	1080/29.97p
	1080/23.98p(59.94i)*1	1080/23.98p(59.94p)*2
	720/59.94p	720/59.94p
50Hz	2160/50p	2160/50p 1080/50p
	2160/25p	2160/25p 1080/25p
	1080/50p	1080/50p
	1080/50i	1080/50i
	1080/25p	1080/25p
	1080/25PsF	1080/25p
	720/50p	720/50p
24Hz	2160/24p	2160/24p 1080/24p
	1080/24p	1080/24p
23.98Hz	2160/23.98p	2160/23.98p 1080/23.98p
	1080/23.98p	1080/23.98p
	1080/23.98PsF	1080/23.98p

*1 It denotes "1080/23.98p over 59.94i".

*2 It denotes "1080/23.98p over 59.94p".

Factory settings:

2160/59.94p (AW-UE80WP/AW-UE80KP)

2160/50p (AW-UE80WE/AW-UE80KE/AW-UE80WED/
AW-UE80KED)

Video Sampling [4:2:2/10bit, 4:2:0/8bit]

When [Format] in [HDMI] is [2160/59.94p] or [2160/50p], select the video sampling output from the HDMI connector.

4:2:2/10bit	Output in 4:2:2/10bit mode.
4:2:0/8bit	Output in 4:2:0/8bit mode.

Factory settings: 4:2:2/10bit

<NOTE>

- When [Format] in [HDMI] is other than [2160/59.94p] or [2160/50p], [Video Sampling] cannot be changed and is fixed at [4:2:2/10bit].

Bar [Camera, Colorbar]

Switch between camera images and color bars.

Camera	Camera images
Colorbar	Color bar

Factory settings: Camera

Color Bar Type [Type1, Type2]

Select the type of color bar to display.

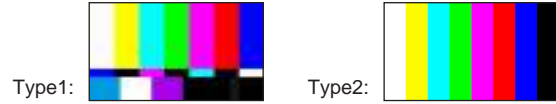

This is only enabled when [Bar] is set to [Colorbar].

Factory settings: Type2

Tone [Off, Low, Normal]

Make the settings for the test tone signal (1 kHz) output while the color bar is displayed.

Off	Test tone is not output.
Low	Test tone is output at low volume.
Normal	Test tone is output at normal volume.

This is only enabled when [Bar] is set to [Colorbar].

Factory settings: Normal

OSD Mix

Selects whether to turn Off/On display of camera menu and status.

3G SDI [Off, On*]

Selects whether to turn this Off/On for images output from 3G SDI OUT connector.

HDMI [Off, On*]

Selects whether to turn this Off/On for images output from HDMI connector.

NDI [Off, On*]

Selects whether to turn this Off/On for images of NDI output from the LAN connector.

IP/NDI | HX [Off, On*]

Selects whether to turn this Off/On for images other than NDI images (H.264/H.265/JPEG/RTMP/SRT/NDI|HX) output from the LAN connector.

Off	The camera menus and statuses are not displayed on the output pictures covered by the setting items listed above.
On	The camera menus and statuses are displayed on the output pictures covered by the setting items listed above.

*: Factory settings

<NOTE>

- When this is set to [Off], the camera menu can be displayed for about 1 minute after the unit is turned on.

OSD Off With R-Tally [Off, On]

Off or on the function that turns off camera menu, status and other displays when red tally signals are received via commands or contacts.

When the red tally signal releases, the camera menu display will return.

Factory settings: Off

Web screen configurations (continued)

OSD Status [Off, On]

Turn the status display during AWB and ABB off/on, or error display when an error occurs.

Factory settings: Off

Tally [Disable, Enable]

[Disable] or [Enable] is set here for the function which turns on or turns off the tally lamp using the tally control signal.

Factory settings: Enable

Tally LED Limit

Sets whether to limit the lighting of the tally lamp for each of the tally control signal colors (R/G).

R [Limit, Unlimit*]

G [Limit, Unlimit*]

Limit	Limit the lighting of the tally lamp.
Unlimit	Light the tally lamp.

*: **Factory settings**

<NOTE>

- If [Disable] is selected for [Tally], the tally status display on external devices (the web screen, controllers such as AW-RP150 and AW-RP60) is also disabled along with the limiting of the tally lamp lighting on this unit.
- If [Limit] is selected for [Tally LED Limit], only lighting of the tally lamp of this unit is limited. The tally status display on external devices (the web screen, controllers such as AW-RP150 and AW-RP60) remains enabled.

Tally Brightness [Low, Mid, High]

Adjust the brightness of the tally LED.

Factory settings: Low

Status Lamp [Disable, Enable]

[Disable] or [Enable] is set here for the status display lamp.

When you want the status display lamp to stay off while this unit is in operation, set to [Disable].

Factory settings: Enable

<NOTE>

- Even when set to [Disable], the status display lamp may light up when this unit is starting up, updating firmware, or trouble is occurring.

External Output

Select the signal type output from the External Output signal lines (Output1, Output2) of the RS-422 connector. (→ page 17)

Output1 [Off*, R-Tally, G-Tally]

Output2 [Off*, R-Tally, G-Tally]

Off	Signal is not output.
R-Tally	The reception status of the red tally signal is output.
G-Tally	The reception status of the green tally signal is output.

*: **Factory settings**

● Pan/Tilt

The setting is confirmed with the [Set] button.



Install Position [Desktop, Hanging]

[Desktop] or [Hanging] is selected here as the method used to install the unit.

Desktop	Stand-alone installation
Hanging	Suspended installation

Factory settings: Desktop

<NOTE>

- When [Hanging] has been selected, the top, bottom, left and right of the images will be reversed, and up/down/left/right control for panning and tilting will also be reversed.

P/T Speed Mode [Normal(60deg/s), Fast1(90deg/s), Fast2(180deg/s)]

Set the speed of pan/tilt operation.

Normal(60deg/s)	Pan/tilt operates at normal speed (maximum about 60° per second).
Fast1(90deg/s)	Pan/tilt operates at fast speed1 (maximum about 90° per second).
Fast2(180deg/s)	Pan/tilt operates at fast speed2 (maximum about 180° per second).

Factory settings: Normal(60deg/s)

P/T Acceleration Setting

P/T Acceleration [Manual, Auto]

Sets whether to perform advance setting for acceleration and deceleration etc. during manual operation of pan/tilt.

Manual	Sets the advanced settings for acceleration speed etc. during start/stop or changing the speed of pan/tilt operation.
Auto	Sets the settings for automatic acceleration and deceleration speed etc. during start/stop or changing the speed of pan/tilt operations.

Factory settings: Auto

Rise S-Curve [0 to 30]

Sets the S-curve for pan/tilt acceleration operation in 31 steps. (The S becomes stronger, the greater the number)

When it is necessary to increase the speed to the specified speed using manual control of pan/tilt by lever operation etc. through the controller, the acceleration process is performed based on the S-curve specified in this setting.

This is enabled only when [P/T Acceleration] is [Manual].

Factory settings: 15

<NOTE>

- In order to limit the acceleration response, in the S-curve step, as the acceleration speed rises, the limit is automatically applied.

Fall S-Curve [0 to 30]

Sets the S-curve for pan/tilt deceleration operation in 31 steps. (The S becomes stronger, the greater the number)

When it is necessary to reduce the speed to the specified speed using manual control of pan/tilt by lever operation etc. through the controller, the deceleration process is performed based on the S-curve specified in this setting.

This is enabled only when [P/T Acceleration] is [Manual].

Factory settings: 15

<NOTE>

- In order to limit the deceleration response, in the S-curve step, as the deceleration speed rises, the limit is automatically applied.

Rise Acceleration [1 to 255]

Sets the acceleration speed for pan/tilt acceleration operation in 255 steps. (The acceleration speed increases as the number increases)

When it is necessary to increase the speed to the specified speed using manual control of pan/tilt by lever operation etc. through the controller, the acceleration process is performed based on the acceleration speed specified in this setting.

This is enabled only when [P/T Acceleration] is [Manual].

Factory settings: 128

<NOTE>

- When the specified acceleration speed is small, it is not possible to reach the maximum speed of the product.

Fall Acceleration [1 to 255]

Sets the deceleration speed for pan/tilt deceleration operation in 255 steps. (The deceleration speed increases as the number increases)

When it is necessary to reduce the speed to the specified speed using manual control of pan/tilt by lever operation etc. through the controller, the deceleration process is performed based on the deceleration speed specified in this setting.

This is enabled only when [P/T Acceleration] is [Manual].

Factory settings: 128

<NOTE>

- The deceleration and stop processes are carried out right up to the end of the lens mechanism section and in order to prevent a collision with the mechanism, in the actual operation, [Fall Acceleration] may be restricted.

Speed With Zoom Position [Off, On]

[Off] or [On] is set here for the function used to adjust the pan-tilt adjustment speed in conjunction with the zoom magnification.

When [On] is set, the panning and tilting operations will become slower in the zoom status.

This function has no effect during preset operations.

Factory settings: On

Focus Adjust With PTZ. [Off, On]

[Off] or [On] is set here for the function which compensates for out-of-focusing when it occurs during panning, tilting or zooming operations.

When [Off] is set, adjust the focus as required after zooming or set [Focus Mode] to [Auto].

This is only enabled when [Manual] has been selected as the [Focus Mode] setting.

Factory settings: Off

Privacy Mode [Off, On]

Sets Off/On the function for facing the camera to the rear when this unit is switched to Standby mode.

Off	Does not change the camera direction when the camera is switched to Standby mode. (The camera remains in the direction it was when the power was turned On)
On	Moves the camera to face toward the rear when the camera is switched to Standby mode. Moves the camera to the position specified in [Power On Position] when the power is turned On again.

Factory settings: Off

Power On Position [Standby, Home, Preset]

Select the initial positions for Pan/Tilt/Zoom when the power is turned on.

Standby	Move to the Pan/Tilt/Zoom positions they were in the last time the camera was switched to Standby mode.
Home	Pan/Tilt move to their home positions (front) and Zoom goes to the Wide end.
Preset	Preset playback is performed at the preset position specified with [Preset Number].

Factory settings: Standby

Preset Number [Preset001 to Preset100]

Specify a number for preset playback when the power turns ON when [Preset] is set in [Power On Position].

Factory settings: Preset001

<NOTE>

- If an unregistered preset number is set, preset playback is not performed and the operation is the same as [Standby].

■ Date & time screen [Date&Time]

Make clock settings.

You can set using one of three types [PC Synchronization], [NTP], or [Manual].

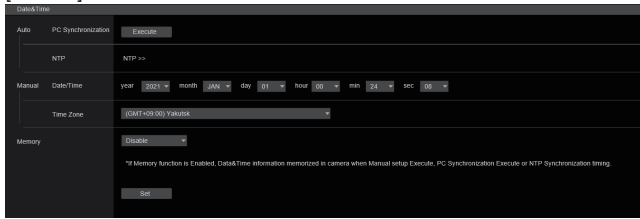

Auto

PC Synchronization

If you click the [Execute] button, the settings are configured by synchronizing the unit to the date and time of the connected personal computer.

<NOTE>

- The time zone of the personal computer is not reflected on the unit. Set the time zone on the unit.

NTP

If you click [NTP>>], the settings screen for the NTP server appears. (→ page 130)

Manual

Date/Time

Configure the settings for the month, day, and year and for the hour, minute, and second.

<NOTE>

- The time is in the 24-hour format.

Time Zone

Selects the time zone according to the region where the camera is being used.

Factory settings:

(GMT) Greenwich Mean Time : Dublin, Edinburgh, Lisbon, London

Memory

Set whether to save the time information to this unit when using [PC Synchronization], [NTP] synchronization, or [Manual] setting.

Factory settings: Disable

<NOTE>

- Set this function to [Enable] when the 802.1X function is to be used. The valid life of the certificate may not be properly determined if this is set to [Disable].

■ Live page screen [Live page]

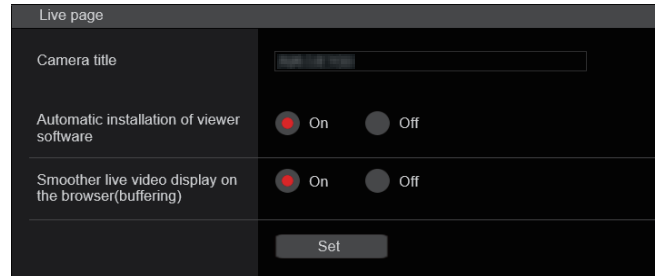

Camera title

Input the name of the camera here.

When the [Set] button is clicked, the input name appears in the camera title display area.

- The factory default setting is the model number of the unit.
- You can enter between 0 to 20 characters.
- The following characters can be displayed.

Numeric characters	0123456789
Alphabetical characters (upper and lower cases)	ABCDEFGHIJKLMNOPQRSTUVWXYZ abcdefghijklmnopqrstuvwxyz
Symbols	!#\$%^()*+,-./:;<=>?@[^_`{ }~\

Automatic installation of viewer software [On, Off]

Windows I.E.11

One of the following settings is selected for the automatic installation of the plug-in viewer software.

Factory settings: On

Smoother live video display on the browser(buffering)

[On, Off] Windows I.E.11

Configure settings for displaying images from the unit on the plug-in viewer software.

On	Temporarily store images from the unit onto the personal computer for smoother display. However, the screen display images will be displayed later than the actual images.
Off	Do not temporarily store images from the unit onto the personal computer, and display them in real time. However, the motion of the screen display images may not be smooth.

Factory settings: On

Image screen [Image/Audio]

IP video settings screen [Video over IP]

The JPEG image and H.264 image settings as well as the settings related to image quality are selected on this screen.

<NOTE>

- IP control can be performed but if you do not want to perform IP image transmission, set [JPEG transmission], [H.264 transmission], [H.265 transmission], [RTMP transmission], [SRT transmission] and [Ts transmission] to [Off].
- When JPEG image transmission is set to [Off], IP images are not displayed in browsers other than Windows Internet Explorer 11. This includes mobile terminals.

Setting status

Setting status					
Streaming mode					
H.264					
Initial display setting					
H.264(1)					
JPEG(1)	Transmission	Image capture size	Refresh interval	Image quality	
	On	1280*720	30fps	Fine	
JPEG(2)	Transmission	Image capture size	Refresh interval	Image quality	
	On	640*380	30ps	Fine	
JPEG(3)	Transmission	Image capture size	Refresh interval	Image quality	
	On	320*180	30fps	Fine	
H.264(1)	Transmission	Image capture size	Transmission priority	Frame rate	Max bitrate
	On	1280*720	30ps	14335.01448fps	
H.264(2)	Transmission	Image capture size	Transmission priority	Frame rate	Max bitrate
	On	1280*720	30ps	8192.420888ps	
H.264(3)	Transmission	Image capture size	Transmission priority	Frame rate	Max bitrate
	On	640*380	30ps	4096.102044ps	
H.264(4)	Transmission	Image capture size	Transmission priority	Frame rate	Max bitrate
	On	640*380	30ps	4096.102044ps	

Streaming mode

The streaming mode setting is displayed.

Initial display setting

The setting for the image displayed when the live screen [Live] is open.

JPEG

The JPEG transmission settings are displayed.

H.264

The H.264 transmission settings are displayed.
These are not displayed when [Streaming mode] is [H.265] or [SRT(H.265)].

H.265

The H.265 transmission settings are displayed.
These are displayed when [Streaming mode] is [H.265] or [SRT(H.265)].

Streaming mode

It is possible to perform IP transmission operations suited to the application by switching the [Streaming mode] on this unit. The setting is confirmed with the [Set] button.

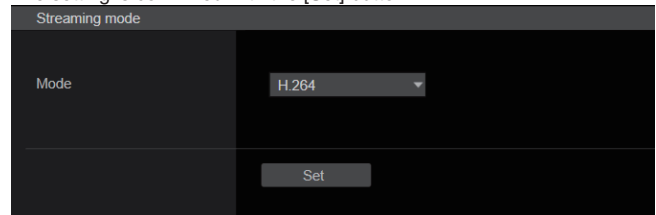

Mode [H.264, H.265, RTMP, SRT(H.264), SRT(H.265), NDI|HX V2, MPEG2-TS over UDP, High bandwidth NDI]

H.264	IP videos can be transmitted over multiple channels. Full HD images are transmitted via IP in the H.264 format.
H.265	IP videos can be transmitted over multiple channels. Full HD images are transmitted via IP in the H.265 format.
RTMP	Full HD images are transmitted via IP in the H.264 format to the RTMP/RTMPS server.
SRT(H.264)	Full HD images are transmitted via IP in the H.264 format to the SRT compatible decoder or service.
SRT(H.265)	Full HD images are transmitted via IP in the H.265 format to the SRT compatible decoder or service.
NDI HX V2	Videos are sent to software applications and hardware compatible with NewTek NDI HX over a network.
MPEG2-TS over UDP	IP videos can be transmitted over multiple channels. Full HD images are transmitted via IP in the H.264 format.
High bandwidth NDI	Videos are sent to software applications and hardware compatible with NewTek High Bandwidth NDI over a network.

Factory settings: H.264

<NOTE>

- When [IP(UDP)] of [Tracking Data Output] is set to [On], video transmission via IP may be delayed or the video may suffer frame loss. (→ page 122)
We recommend setting [IP(UDP)] of [Tracking Data Output] to [Off] to avoid the delay or frame loss due to the video transmission via IP.
- NDI|HX V2 is an abbreviation of NDI|HX version 2.

Web screen configurations (continued)

● Initial display setting

Set initial display settings for the Live screen [Live].
The setting is confirmed with the [Set] button.

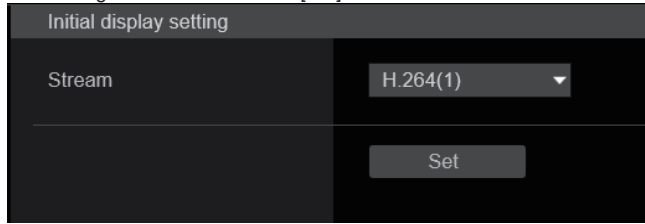

Stream [H.264(1), H.264(2), H.264(3), H.264(4), JPEG(1), JPEG(2), JPEG(3)]

Select the type of images to display in the Live screen [Live].

H.264(1) Windows I.E.11	Display videos (H.264(1)).
H.264(2) Windows I.E.11	Display videos (H.264(2)).
H.264(3) Windows I.E.11	Display videos (H.264(3)).
H.264(4) Windows I.E.11	Display videos (H.264(4)).
JPEG(1)	Display still images (JPEG(1)).
JPEG(2)	Display still images (JPEG(2)).
JPEG(3)	Display still images (JPEG(3)).

Factory settings: H.264(1)

<NOTE>

- This setting may switch automatically according to the [Streaming mode].

● JPEG

Set JPEG image settings.

The setting is confirmed with the [Set] button.

There are a total of 3 channels available for JPEG image setting.

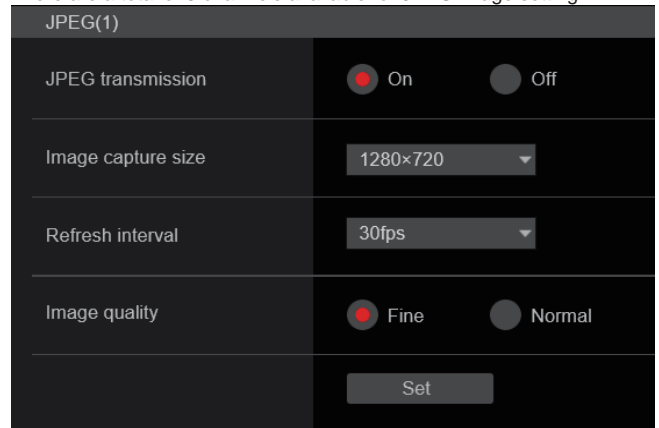

<NOTE>

- [JPEG(2)] and [JPEG(3)] cannot be set when the [Streaming mode] is [NDI|HX V2] or [High bandwidth NDI].

JPEG transmission [On, Off]

Set whether to transmit JPEG images.

Factory settings: On

Image capture size [1920×1080, 1280×720, 640×360, 320×180]

When displaying JPEG images, select the resolution for image display from the following.

JPEG(1)	1920×1080, 1280×720, 640×360, 320×180
JPEG(2)	640×360, 320×180
JPEG(3)	640×360, 320×180

Factory settings:

JPEG(1): 1280×720

JPEG(2): 640×360

JPEG(3): 320×180

Refresh interval [1fps, 4fps, 5fps, 12fps, 12.5fps, 15fps, 24fps, 25fps, 30fps]

Select the frame rate for JPEG images.

59.94Hz	1fps/5fps/15fps/30fps
50Hz	1fps/5fps/12.5fps/25fps
24/23.98Hz	1fps/4fps/12fps/24fps

Factory settings:

For 59.94Hz:

JPEG(1): 30fps

JPEG(2): 5fps

JPEG(3): 30fps

For 50Hz:

JPEG(1): 25fps

JPEG(2): 5fps

JPEG(3): 25fps

For 24/23.98Hz:

JPEG(1): 24fps

JPEG(2): 4fps

JPEG(3): 24fps

<NOTE>

- The frame rate may be slower depending on the network environment, resolution, image quality, access volume, etc.
- If images are not transmitted at the specified frame rate, lowering the resolution or image quality may result in transmissions closer to the specified value.

Image quality [Fine, Normal]

Specify the JPEG image quality for each resolution.

Factory settings: Fine

● **H.264**

Set H.264 image settings.

The setting is confirmed with the [Set] button.



<NOTE>

- On browsers other than Internet Explorer 11, only JPEG images can be displayed.
- H.264 cannot be set when the [Streaming mode] is [H.265], [NDI|HX V2] or [High bandwidth NDI].
- When starting RTSP/RTP transmissions, set the following URLs for the decoders and applications.
 - For H.264(1): rtsp://[unit's IP address]/MediaInput/h264/stream_1
 - For H.264(2): rtsp://[unit's IP address]/MediaInput/h264/stream_2
 - For H.264(3): rtsp://[unit's IP address]/MediaInput/h264/stream_3
 - For H.264(4): rtsp://[unit's IP address]/MediaInput/h264/stream_4

[/MediaInput/h264/stream_*] can be changed in [RTSP] of [Advanced]. (→ page 133)

H.264 transmission [On, Off]

Whether to transmit the H.264 images is set here.

Factory settings: On

Internet mode(Over HTTP) [On, Off]

This setting is selected when transmitting H.264 images over the Internet.

H.264 images can be transmitted using the same broadband router settings as when transmitting JPEG images.

On	The H.264 images and audio are transmitted using the HTTP port. For details on setting the HTTP port number, refer to page 128.
Off	The H.264 images and audio are transmitted using the UDP port.

Factory settings: Off

<NOTE>

- When [On] is set, only [Unicast port(AUTO)] can be selected as the [Transmission type] setting.
- When [On] is set, it takes a few seconds before the H.264 images are displayed.
- When this is set to [On], access will be limited to IPv4.
- This function is only reflected in the H.264 images displayed in the live screen [Live].

Profile type [High, Main, Baseline]

Set the profile for when H.264 images are transmitted.

Factory settings: High

Web screen configurations (continued)

Image capture size [1920×1080, 1280×720, 640×360, 320×180]

Select the resolution for H.264 images.

Selectable options will vary depending on the selected resolution setting.

H.264(1)	1920×1080, 1280×720
H.264(2)	1920×1080, 1280×720, 640×360, 320×180
H.264(3)	1280×720, 640×360, 320×180
H.264(4)	1280×720, 640×360, 320×180

Factory settings:

H.264(1): 1920×1080

H.264(2): 1280×720

H.264(3): 640×360

H.264(4): 640×360

Transmission priority [Constant bit rate, Frame rate, Best effort]

Set the transmission mode for H.264 images.

Constant bit rate	Transmits H.264 images at the bit rate specified in [Max bit rate(per client)]. • The "Frame rate" value is automatically determined (as 5fps to 30fps or 5fps to 25fps) according to the selected bit rate. (→ page 103)
Frame rate	Transmit H.264 images at the frame rate specified in [Frame rate]. • Set the frame rate and bit rate and transmit. (→ page 103, page 103)
Best effort	Transmit H.264 images at a variable bit rate between the maximum and minimum specified in [Max bit rate(per client)], according to the network bandwidth. • Depending on how the bit rate is changed, the "Frame rate" value is automatically determined (as 5fps to 30fps or 5fps to 25fps). (→ page 103)

Factory settings: Frame rate

<NOTE>

- This cannot be set when the frame frequency is 24/23.98Hz.

Frame rate [5fps, 12.5fps, 15fps, 24fps, 25fps, 30fps, 50fps, 60fps]

Set the frame rate for H.264 images.

59.94Hz	5fps/15fps/30fps/60fps
50Hz	5fps/12.5fps/25fps/50fps
24/23.98Hz	24fps

Factory settings:

For 59.94Hz: 30fps

For 50Hz: 25fps

For 24/23.98Hz: 24fps

<NOTE>

- [60fps(50fps)] cannot be selected when the video format is [29.97p(25p)].

Max bit rate(per client)

[512kbps, 768kbps, 1024kbps, 1536kbps, 2048kbps, 3072kbps, 4096kbps, 6144kbps, 8192kbps, 10240kbps, 12288kbps, 14336kbps, 16384kbps, 20480kbps, 24576kbps]

Specify the H.264 bit rate per client.

When [Transmission priority] is set to [Best effort], specify the maximum and minimum bit rate.

Factory settings:

H.264(1): 14336kbps

H.264(2): 8192kbps

H.264(3): 4096kbps

H.264(4): 4096kbps

<NOTE>

- The setting range depends on the resolution.

Image quality [Motion priority, Image quality priority]

Select the image quality for H.264 images.

Motion priority	Mode giving priority to image motion.
Image quality priority	Mode giving priority to image quality.

Factory settings: Motion priority

<NOTE>

- This setting is only enabled when [Transmission priority] is set to [Constant bit rate] or [Best effort].

Transmission type [Unicast port(AUTO), Unicast port(MANUAL), Multicast]

Select the transmission format for H.264 images.

Unicast port(AUTO)	Up to 14 users can access a single camera at the same time. [Unicast port(Image)] and [Unicast port(Audio)] will be configured automatically when images and audio are sent from the camera. We recommend selecting the [Unicast port(AUTO)] setting when the port number transmitting the H.264 images does not need to be fixed (e.g., during use within a network).
Unicast port(MANUAL)	Up to 14 users can access a single camera at the same time. [Unicast port(Image)] and [Unicast port(Audio)] must be configured manually when images and audio are sent from the camera. When transmitting H.264 images via the Internet, configure a fixed transmission port for the broadband router (hereafter referred to as "router") (→ page 126). For details, refer to the operating instructions for the router.
Multicast	An unlimited number of users can access a single camera at the same time. When transmitting H.264 images via multicast, enter the [Multicast address], [Multicast port], and [Multicast TTL/HOPLimit].

Factory settings: Unicast port(AUTO)

<NOTE>

- For details on the maximum number for simultaneous access, see <NOTE> (→ page 84).

Web screen configurations (continued)

Unicast port(Image) [1024 to 50000]

Enter the unicast port number (used when sending images from the unit).

Only even numbers can be specified.

The port number cannot be set to 10670.

Factory settings:

H.264(1): 32004
 H.264(2): 32014
 H.264(3): 32024
 H.264(4): 32034

Unicast port(Audio) [1024 to 50000]

Only even numbers can be specified.

The port number cannot be set to 10670.

Factory settings:

H.264(1): 33004
 H.264(2): 33014
 H.264(3): 33024
 H.264(4): 33034

<NOTE>

- The unicast port number must be configured when [Transmission type] is set to [Unicast port(MANUAL)].

Multicast address

[IPv4: 224.0.0.0 to 239.255.255.255]

[IPv6: Multicast address starting with FF]

Enter the multicast IP address.

Images and audio will be sent to the specified IP address.

Factory settings:

H.264(1): 239.192.0.20
 H.264(2): 239.192.0.21
 H.264(3): 239.192.0.22
 H.264(4): 239.192.0.23

<NOTE>

- Verify usable multicast IP addresses before entering this setting.
- This setting does not work with the multicast address for link local scope.

Multicast port [1024 to 50000]

Enter the multicast port number (used when sending images from the unit).

Only even numbers can be specified.

The port number cannot be set to 10670.

Factory settings: 37004

<NOTE>

- When sending audio from the unit, a port number with "1000" added to the multicast port number will be used.

Multicast TTL/HOPLimit [1 to 254]

Enter the TTL/HOPLimit value for multicast.

Factory settings: 16

<NOTE>

- When transmitting H.264 images via the Internet, transmitted images may not appear depending on proxy server settings, firewall settings, etc. In such cases, consult your network administrator.
- When displaying multicast images on a personal computer with multiple LAN cards installed, disable the LAN cards that are not used for reception.

● H.265

Set H.265 image settings.

The setting is confirmed with the [Set] button.



<NOTE>

- H.265 format images cannot be displayed in the live screen [Live] of the unit.
- Use external devices and software compatible with H.265 images to display H.265 images.
- When starting RTSP/RTP transmissions, set the following URLs for the decoders and applications.
 - For H.265(1):
rtsp://[unit's IP address]/MediaInput/h265/stream_1
 - For H.265(2):
rtsp://[unit's IP address]/MediaInput/h265/stream_2

[/MediaInput/h265/stream_*] can be changed in [RTSP] of [Advanced]. (→ page 133)

H.265 transmission [On, Off]

Whether to transmit the H.265 images is set here.

Factory settings: On

Image capture size [1920×1080, 1280×720, 640×360]

Select the resolution for H.265 images.

Selectable options will vary depending on the selected resolution setting.

H.265(1)	1920x1080, 1280x720
H.265(2)	1920x1080, 1280x720, 640x360

Factory settings:

H.265(1): 1920x1080
 H.265(2): 1280x720

Web screen configurations (continued)

Frame rate [24fps, 25fps, 30fps, 50fps, 60fps]

Set the frame rate for H.265 images.

59.94Hz	30fps, 60fps
50Hz	25fps, 50fps
24/23.98Hz	24fps

Factory settings:

For 59.94Hz: 30fps

For 50Hz: 25fps

For 24/23.98Hz: 24fps

<NOTE>

- [60fps(50fps)] cannot be selected when the video format is [29.97p(25p)].

Max bit rate(per client)

[512kbps, 768kbps, 1024kbps, 1536kbps, 2048kbps, 3072kbps, 4096kbps, 6144kbps, 8192kbps, 10240kbps, 12288kbps, 14336kbps, 16384kbps, 20480kbps, 24576kbps]

Specify the H.265 bit rate per client.

Factory settings:

H.265(1): 14336kbps

H.265(2): 8192kbps

Transmission type

The same as H.264 Transmission type (→ page 103).

Unicast port(Image)

The same as H.264 Unicast port(Image) (→ page 104).

Unicast port(Audio)

The same as H.264 Unicast port(Audio) (→ page 104).

Multicast address

The same as H.264 Multicast address (→ page 104).

Multicast port

The same as H.264 Multicast port (→ page 104).

Multicast TTL/HOPLimit

The same as H.264 Multicast TTL/HOPLimit (→ page 104).

● RTMP

Make RTMP/RTMPS transmission settings.

Server setup

The setting is confirmed with the [Set] button.

Server setup	
URL type	<input type="radio"/> Type1 <input checked="" type="radio"/> Type2
URL	
Server URL	<input type="text"/>
Stream key	<input type="text"/>
<input type="button" value="Set"/>	

<NOTE>

- Switch to the appropriate method of registering RTMP/RTMPS transmission server information suited to the setting information notified from the RTMP/RTMPS transmission server you are using.
- The Stream Key setting field is displayed only when [Type2] is set.
- When performing RTMP transmissions, set the Server URL and Stream key acquired from the external application, and then click the [start] button for [SRT/MPEG2-TS/RTMP] in the live screen [Live].
- When performing RTMP transmissions, enable connection with the network in the [Network] screen.

URL type [Type1, Type2]

Select the method for registering the information for the RTMP/RTMPS transmission server.

Type1	Specify to set the server URL and RTMP/RTMPS stream key as a set in [Server URL].
Type2	Specify to individually set the server URL and RTMP/RTMPS stream key in [Server URL] and [Stream Key].

URL

Server URL

Set the URL for the RTMP/RTMPS server to be transmitted to.

Stream key

The stream key obtained from the RTMP/RTMPS server is set during streaming only when the service is set to [Type2].

Streaming format

Make settings for H.264 images for use in RTMP/RTMPS transmission.

The setting is confirmed with the [Set] button.

Refer to the explanation for H.264 (→ page 102) for information about Image capture size, Frame rate and Max bit rate(per client).

Streaming format	
RTMP transmission	<input checked="" type="radio"/> On <input type="radio"/> Off
Profile type	<input checked="" type="radio"/> High <input type="radio"/> Main <input type="radio"/> Baseline
Image capture size	<input type="text" value="1920x1080"/>
Frame rate	<input type="text" value="30fps"/>
Max bit rate(per client)	Max <input type="text" value="14336kbps"/>
<input type="button" value="Set"/>	

<NOTE>

- Streaming format settings cannot be changed during RTMP/RTMPS transmissions.
- When [IP(UDP)] of [Tracking Data Output] is set to [On], video transmission via IP may be delayed or the video may suffer frame loss. (→ page 122)
We recommend [IP(UDP)] of [Tracking Data Output] is set to [Off] during RTMP/RTMPS transmission.
- Set the Streaming format to the settings recommended for the transmission destination server. Visit the publisher's website or contact them about the recommended values.

Web screen configurations (continued)

● SRT

Make SRT transmission settings.

<NOTE>

- When starting SRT transmissions in the [Listener] mode, set the decoder and application to [Client(Caller)] mode and set the following URL:
srt://[unit's IP address]:[value set in Client(Caller) port]
- When performing SRT transmissions in the [Client(Caller)] mode, set the IP address and port number of the decoder and application to [Destination URI] and [Destination port], and then click the [start] button for [SRT/MPEG2-TS/RTMP] in the live screen [Live].
- [Passphrase], [Stream ID], etc., can also be specified with options.

Common setup

The setting is confirmed with the [Set] button.

Common setup	
Mode	<input type="radio"/> Client(Caller) <input checked="" type="radio"/> Listener
Destination URI	<input type="text" value="192.168.0.3"/>
Destination port	<input type="text" value="7002"/> (1-65535)
Stream ID	<input type="text" value="#!::m=publish,r=PanasonicStream"/> <input type="button" value="InsertTemplate"/>
Client(Caller) port	<input type="text" value="2020"/> (1-65535)
TTL/HOP Limit	<input type="text" value="16"/> (1 - 254)
Latency	<input type="text" value="120"/>
Encryption	<input checked="" type="radio"/> Off <input type="radio"/> AES-128 <input type="radio"/> AES-256
Passphrase	<input type="text"/>
<input type="button" value="Set"/>	

Mode [Client(Caller), Listener]

Selects the method to connect to the SRT compatible decoder or service.

Client(Caller)	Specify the transmission destination IP address and port number when starting transmission from this unit.
Listener	Specify the listener port when awaiting the external request to start transmission.

Factory settings: Listener

Destination URI

When [Client(Caller)] is set in [Mode], enter the IP address. Images and audio will be sent to the specified IP address.

Factory settings: 192.168.0.3

<NOTE>

- Only IPv4 can be set as the IP address.

Destination port [1 to 65535]

When [Client(Caller)] is set in [Mode], enter the port number (used when transmitting images from this unit).

Connection is to the specified port number.

Factory settings: 7002

<NOTE>

- The following port numbers are used by the unit so they cannot be used.
20, 21, 23, 25, 42, 53, 67, 68, 69, 80, 110, 123, 161, 162, 443, 546, 547, 554, 995, 5960 to 5985, 7960 to 8060, 10669, 10670, 11900, 59000 to 61000

Stream ID

When [Client(Caller)] is set in [Mode], enter the Stream ID.

The information entered is notified to the connection destination when SRT transmission is started.

If the [InsertTemplate] button is clicked, the following template is inserted in the input fields.

#!::m=publish,r=PanasonicStream

- The following characters can be displayed.

Numeric characters	0123456789
Alphabetical characters (upper and lower cases)	ABCDEFGHIJKLMNOPQRSTUVWXYZ abcdefghijklmnopqrstuvwxyz
Symbols	!"#\$%&'()*--^`\ @[]*+;<>.,?^_

Factory settings: #!::m=publish,r=PanasonicStream

Client(Caller) port [1 to 65535]

When [Listener] is set in [Mode], enter the port number (used when this unit is waiting for a connection).

The following port numbers are used by the unit so they cannot be used.

20, 21, 23, 25, 42, 53, 67, 68, 69, 80, 110, 123, 161, 162, 443, 546, 547, 554, 995, 5960 to 5985, 7960 to 8060, 10669, 10670, 11900, 59000 to 61000

Factory settings: 2020

TTL/HOP Limit

The same as H.264 [Multicast TTL/HOPLimit] (→ page 104).

<NOTE>

- When streaming SRT via a public network, it is recommended to change the TTL setting to a suitable value (64, etc.).

Latency

Sets the time between when images and audio are sent and when they are played on the receiving device in a range between 0 and 99999 (ms).

Factory settings: 120

<NOTE>

- In some cases, the set time is not guaranteed depending on the network band.

Encryption [Off, AES-128, AES-256]

Sets whether to encrypt the transmitted IP image.

Off	Transmits unencrypted IP images.
AES-128	Encrypts IP images in AES-128 before transmitting.
AES-256	Encrypts IP images in AES-256 before transmitting.

Factory settings: Off

- The following characters can be displayed.

Numeric characters	0123456789
Alphabetical characters (upper and lower cases)	ABCDEFGHIJKLMNOPQRSTUVWXYZ abcdefghijklmnopqrstuvwxyz
Symbols	_ -

Passphrase

Sets the phrase used for decoding the encrypted IP images.

(10 to 24 characters)

Streaming format

Makes settings for H.264 or H.265 images for use in SRT transmission.

The setting is confirmed with the [Set] button.

Refer to the explanation for H.264 (→ page 102) or H.265 (→ page 104) for information about Image capture size, Frame rate and Max bit rate(per client).

<NOTE>

- Streaming format settings cannot be changed during SRT transmissions.
- When [IP(UDP)] of [Tracking Data Output] is set to [On], video transmission via IP may be delayed or the video may suffer frame loss. (→ page 122)
We recommend [IP(UDP)] of [Tracking Data Output] is set to [Off] during SRT transmission.
- When the frame frequency is 24/23.98Hz, you cannot set to the SRT(H.264), or SRT(H.265) modes.

● MPEG2-TS over UDP

Make settings for MPEG2-TS over UDP transmission.

<NOTE>

- In order to receive the images being transmitted by the camera, enter the following URL in the application or service.
 - For Unicast
udp://@[unicast ipaddress]:[unicast port]
 - For Multicast
udp://@[multicast ipaddress]:[multicast port]

Transmission type [Unicast, Multicast]

Sets the transmission type for MPEG2-TS over UDP transmission as either Unicast or Multicast.

Factory settings: Unicast

Unicast address(IPv4)

Sets the Unicast address used for MPEG2-TS over UDP transmission.

Specify this IP address on the receiving application or service.

Factory settings: 192.168.0.3

Unicast Port [1024 to 50000]

Sets the Unicast port number used for MPEG2-TS over UDP transmission.

Specify this port number on the receiving application or service.

Factory settings: 7002

Multicast address(IPv4)

Sets the Multicast address used for MPEG2-TS over UDP transmission.

Specify this IP address on the receiving application or service.

Factory settings: 239.192.0.20

Multicast Port [1024 to 50000]

Sets the Multicast port number used for MPEG2-TS over UDP transmission.

Specify this port number on the receiving application or service.

Factory settings: 32004

Multicast TTL/HOPLimit

The same as H.264 [Multicast TTL/HOPLimit] (→ page 104).

Push UDP [Enable, Disable]

When Push UDP has been set to Enable, MPEG2-TS over UDP transmission starts automatically when the camera is started.

Factory settings: Enable

Streaming format

Make settings for H.264 images used for MPEG2-TS over UDP transmission.

The setting is confirmed with the [Set] button.

Refer to the description of H.264 (→ page 102) for information about Image capture size, Frame rate, and Max bit rate(per client).

<NOTE>

- Streaming format settings cannot be changed during MPEG2-TS over UDP transmissions.
- When [IP(UDP)] of [Tracking Data Output] is set to [On], video transmission via IP may be delayed or the video may suffer frame loss. (→ page 122)
We recommend [IP(UDP)] of [Tracking Data Output] is set to [Off] during MPEG2-TS over UDP transmission.

Web screen configurations (continued)

● NDI|HX V2

Make NDI|HX V2 transmission settings.
The setting is confirmed with the [Set] button.

NDI|HX V2

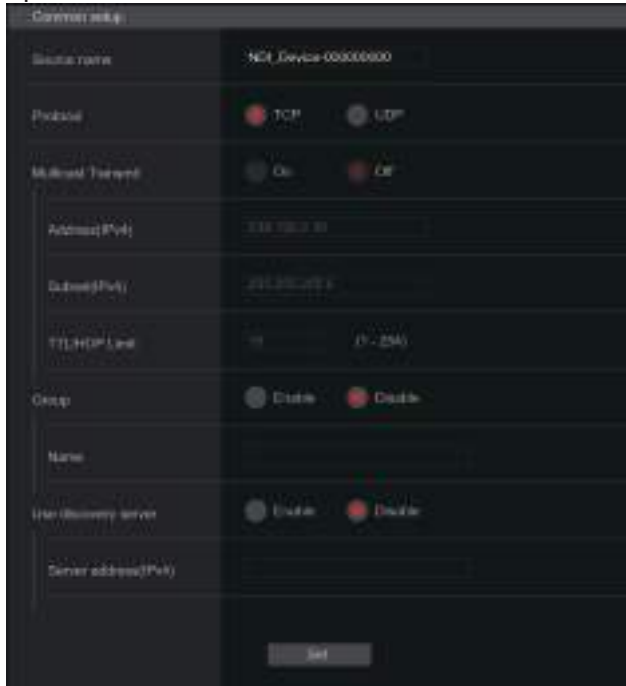

<NOTE>

- This unit restarts when [Streaming mode] is changed to [NDI|HX V2], or when changed from [NDI|HX V2] to another mode.

Source name

Sets the device name displayed when this unit is detected by software applications and hardware compatible with NDI|HX.

Factory settings: NDI_Device-[serial number of this unit]

Maximum number of characters	1 to 32 characters
Characters that can be entered	Alphanumeric characters, symbols: - _

Protocol [TCP, UDP]

Sets the format of unicast transmission to be used.

Factory settings: TCP

Multicast Transmit [On, Off]

Sets whether to perform multicast transmissions of images for software applications and hardware that are compatible with NDI.

Factory settings: Off

Address(IPv4) [IPv4 : 244.0.0.0 to 239.255.255.255]

Enter the multicast IP address.

Images and audio are transmitted to the specified multicast address.

Factory settings: 239.192.0.30

<NOTE>

- Check the multicast IP addresses available for use before entering.

Subnet(IPv4)

Enter the subnet mask.

Factory settings: 244.0.0.0

<NOTE>

- [Address (IPv4)] and [Subnet (IPv4)] clarify the multicast address ranges randomly set during multicast transmissions.
- When [Address (IPv4)] is set to [239.255.0.0] and [Subnet (IPv4)] is set to [255.255.0.0], the selection is made randomly in the range between [239.255.0.0] and [239.255.255.255].
- To use the IP address set in [Address (IPv4)], set [Subnet (IPv4)] to [255.255.255.255].

TTL/HOP Limit

The same as the H.264 [Multicast TTL/HOPLimit] (→ page 104) .

Group [Enable, Disable]

Sets whether to use the grouping function when performing NDI transmission.

Factory settings: Disable

Name

Sets the group name for use when the grouping function is used.

Maximum number of characters	1 to 32 characters
Characters that can be entered	Alphanumeric characters

Use discovery server

Sets whether to use the discovery server when performing NDI transmission.

Server address(IPv4)

Sets the IPv4 address of the server when using the discovery server.

Streaming format

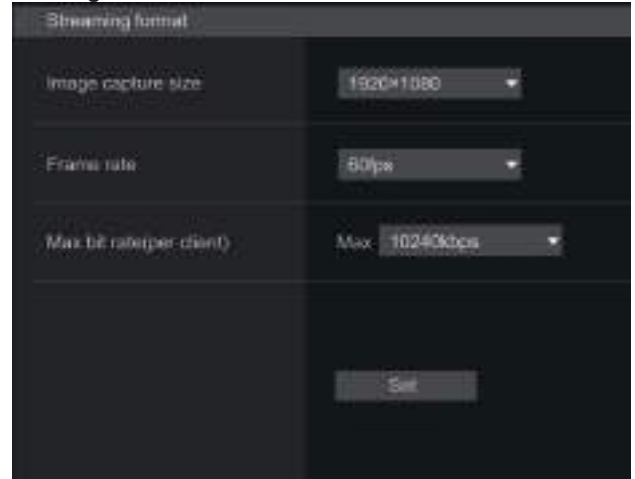

Make settings for H.264 images used for NDI|HX V2 transmission. Confirm the settings with the [Set] button.

Refer to the description of H.264 (→ page 102) for information about [Image capture size], [Frame rate], and [Max bit rate(per client)].

● High bandwidth NDI

Make NDI transmission settings.

The setting is confirmed with the [Set] button.

High bandwidth NDI

Format

Displays the resolution of NDI images.

<NOTE>

- For the resolution set to Format, confirm the output conditions for each video format (→ page 19).

Source name

Set the device name displayed when this unit is detected by software applications and hardware compatible with NDI.

Factory settings: NDI Device [serial number of this unit]

Protocol [TCP, UDP]

Sets the format of unicast transmission to be used.

Factory settings: TCP

Multicast Transmit [On, Off]

Sets whether to perform multicast transmission of images for the software applications and hardware compatible with NDI.

Factory settings: Off

Address(IPv4)

[IPv4 : 244.0.0.0 to 239.255.255.255]

Enter the multicast IP address.

Images and audio will be sent to the specified IP address.

Factory settings: 239.192.0.30

<NOTE>

- Verify usable multicast IP addresses before entering this setting.

Subnet(IPv4)

Enter the subnet mask.

Factory settings: 224.0.0.0

<NOTE>

- [Address(IPv4)] and [Subnet(IPv4)] clarify the multicast address ranges randomly selected during multicast transmissions.
- When [Address(IPv4)] is set to "239.255.0.0" and [Subnet(IPv4)] is set to "255.255.0.0", the selection is made randomly in the range between "239.255.0.0" and "239.255.255.255".
- To use the IP address set in [Address(IPv4)], set [Subnet(IPv4)] to "255.255.255.255".

TTL/HOP Limit

The same as H.264 [Multicast TTL/HOPLimit] (→ page 104).

Group [Enable, Disable]

Sets whether to use the grouping function when performing NDI transmission.

Factory settings: Disable

Name

Sets the group name for use when grouping function is used.

Use discovery server

Sets whether to use the discovery server when performing NDI transmission.

Server address(IPv4)

Sets the IPv4 address of the server when using the discovery server.

■ Audio setting screen [Audio]

Configure audio settings.

<NOTE>

- Images and audio are not synchronized. Therefore, images and audio may be slightly out of sync.
- The audio may skip depending on the network environment.

● Setting status

Setting status					
Audio	Input Type	Volume Level CH1	Volume Level CH2	Plugin Power	
Off	Line	0dB	0dB	Off	
Audio over IP			Audio bit rate		
Audio transmission			128kbps		
On					

Audio

Audio

The setting status of audio input is displayed.

Input Type

The setting status of the audio input type is displayed.

Volume Level CH1

Set the volume of audio output (CH1).

This is only enabled when [Audio] is set to [On].

Volume Level CH2

Set the volume of audio output (CH2).

This is only enabled when [Audio] is set to [On].

Plugin Power

The setting status of audio plugin power is displayed.

Audio over IP

Audio transmission

The setting status of audio data IP transmission is displayed.

Audio bit rate

The bit rate setting status for audio data via IP transmission is displayed.

● Audio

The setting is confirmed with the [Set] button.

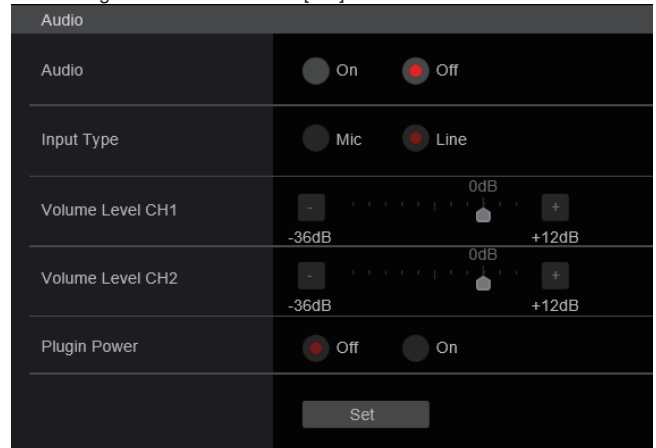

Audio [Off, On]

Turn audio input off/on.

Factory settings: Off

Input Type [Mic, Line]

Mic	Set the microphone input.
Line	Set the line input.

This is only enabled when [Audio] is set to [On].

Factory settings: Line

Volume Level CH1 [-36dB to +12dB]

Set the volume of audio output (CH1).

This is only enabled when [Audio] is set to [On].

Factory settings: 0dB

Volume Level CH2 [-36dB to +12dB]

Set the volume of audio output (CH2).

This is only enabled when [Audio] is set to [On].

Factory settings: 0dB

Plugin Power [Off, On]

Turn the plugin power for the audio off/on.

This is only enabled when [Audio] is set to [On].

This is only enabled when [Input Type] is set to [Mic].

Factory settings: Off

● Audio over IP

The setting is confirmed with the [Set] button.



Audio transmission [Off, On]

Set the communication mode used to transmit audio data to a personal computer, etc.

Off	Do not transmit audio data. All settings and controls related to audio will be disabled.
On	Transmit audio data. This allows audio as well as images to be viewed on the personal computer.

Factory settings: On

Audio bit rate [64kbps, 96kbps, 128kbps]

Set the bit rate for transmitting audio.

Factory settings: 128kbps

■ Image adjust screen [Image adjust]

Adjust the image quality.

The settings in this screen (with the exception of [Scene] and [Matrix]) are applied immediately. After selecting the settings for [Scene] and [Matrix], you need to press the [Set] button to execute.

Scene [Full Auto, Scene1, Scene2, Scene3]



Switch the shooting mode depending on the shooting environment. Select a shooting mode based on the shooting conditions or preference.

Select a shooting mode from the pull-down menu, and click the [Set] button to switch to the selected mode.

Full Auto	Modes that allow you to adjust detailed settings manually for various shooting conditions and preferences. MENU setting items that are treated automatically will have "--" displayed and the setting cannot be changed.
Scene1	The various image quality setting items are initialized to the same values as [Full Auto], and then the settings for the items can be changed.
Scene2	The various image quality setting items are initialized to be suited to low-light environments, and then the settings for the items can be changed.
Scene3	The various image quality setting items are initialized to values that prioritize manual operations, and then the settings for the items can be changed.

Factory settings: Full Auto

Scene Copy



This is selected to copy the various bits of Scene data recorded in the camera ([Full Auto]/[Scene1]/[Scene2]/[Scene3]) to each other.

From [Full Auto, Scene1, Scene2, Scene3]

Select the Scene to copy data from.

Factory settings: Scene1

To [Full Auto, Scene1, Scene2, Scene3]

Select the Scene to copy data to.

Factory settings: Scene1

<NOTE>

- When copying between [Full Auto], and [Scene1] to [Scene3], some setting values may be changed according to some exclusive conditions.
- When [From] is [Full Auto], for items that are operating as [Auto], the operating setting values are applied at the time that the copy is implemented.

Camera control/Setup Menu button



You can display the camera control screen by clicking the [Camera control] button.

You can control the camera while adjusting the image quality.

● Brightness

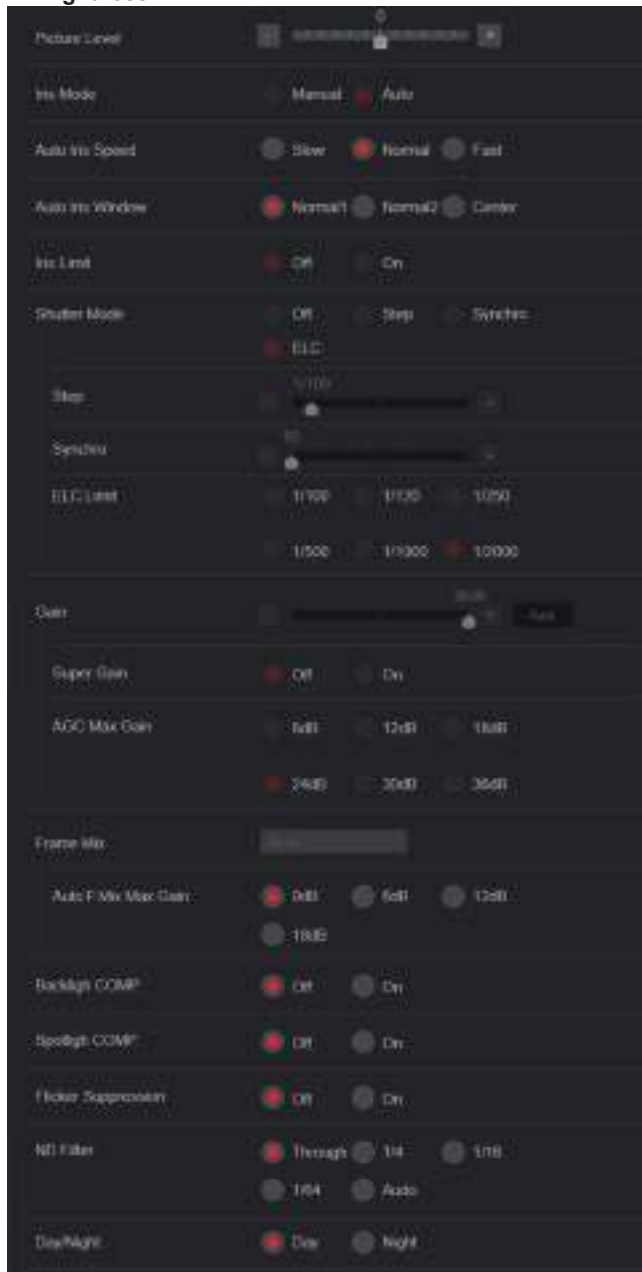

Picture Level [-50 to +50]

This menu item is selected to set the target picture level for automatic exposure compensation.

Its setting takes effect when [Auto] or [ELC] has been selected as the setting for any of the following automatic exposure compensation functions.

- When [Iris Mode] is set to [Auto]
- When [Shutter Mode] is set to [ELC]
- When [Gain] is set to [Auto]
- When [Frame Mix] is set to [Auto]

Factory settings: 0

Iris Mode [Manual, Auto]

This menu item is used to select whether the iris is to be adjusted automatically or manually.

Manual	The iris is adjusted manually.
Auto	Auto exposure compensation is performed so that the target level which was set using [Picture Level] is reached.

Factory settings: Refer to the “Camera menu item table”.

Auto Iris Speed [Slow, Normal, Fast]

Set the control speed of the auto iris function.

Slow	Control the iris at a slow speed.
Normal	Control the iris at a normal speed.
Fast	Control the iris at a fast speed.

Factory settings: Normal

Auto Iris Window [Normal1, Normal2, Center]

Select the detection window for the auto iris.

Normal1	Window towards the center of the screen.
Normal2	Window towards the bottom of the screen.
Center	Spotted window in the center of the screen.

Factory settings: Normal1

Iris Limit [Off, On]

When [Iris Mode] is [Manual], set the function for limiting the iris from closing to Off/On.

Off	The iris will operate within the entire range from OPEN to CLOSE.
On	Set the limit so that the iris does not CLOSE.

Factory settings: Off

<NOTE>

- This is enabled only when [Iris Mode] is [Manual].
- Even if this function is set to [On], the iris OPEN direction limit is not applied.
However, even if this function is set to [On], when auto black balance adjustment (ABB) is executed, it is necessary to CLOSE the iris before performing adjustment.

Shutter Mode [Off, Step, Synchro, ELC]

Select for camera shutter mode.

Off	The shutter is set to OFF.
Step	The step shutter is set (the steps can be changed).
Synchro	The synchro shutter is set (the setting can be changed continuously).
ELC	The electronic shutter is controlled and the light quantity is adjusted automatically.

Factory settings: Refer to the “Camera menu item table”.

Step/Synchro

This is used to adjust the shutter speed in the mode which was selected as the [Shutter Mode] setting.

When a higher shutter speed is selected, fast-moving subjects do not become blurred easily but the images will be darker.

Web screen configurations (continued)

The shutter speeds that can be set are listed below.

	When [Step] is selected as the [Shutter Mode]	When [Synchro] is selected as the [Shutter Mode]
59.94p/59.94i mode	1/60, 1/100, 1/120, 1/250, 1/500, 1/1000, 1/2000, 1/4000, 1/8000, 1/10000	60.0 Hz to 7200 Hz
29.97p mode	1/30, 1/60, 1/100, 1/120, 1/250, 1/500, 1/1000, 1/2000, 1/4000, 1/8000, 1/10000	30.0 Hz to 7200 Hz
23.98p/24p mode	1/24, 1/48, 1/60, 1/100, 1/120, 1/250, 1/500, 1/1000, 1/2000, 1/4000, 1/8000, 1/10000	24.0 Hz to 7200 Hz
50p/50i mode	1/60, 1/100, 1/120, 1/250, 1/500, 1/1000, 1/2000, 1/4000, 1/8000, 1/10000	50.0 Hz to 7200 Hz
25p mode	1/25, 1/50, 1/60, 1/100, 1/120, 1/250, 1/500, 1/1000, 1/2000, 1/4000, 1/8000, 1/10000	25.0 Hz to 7200 Hz

Factory settings: Refer to the "Camera menu item table".

<NOTE>

- When [Shutter Mode] is set to [Off] in 29.97p, 23.98p/24p, or 25p mode, the shutter speed is set to [1/50].

ELC Limit [1/100, 1/120, 1/250, 1/500, 1/1000, 1/2000]

Set the maximum shutter level when ELC is operating.

Factory settings: Refer to the "Camera menu item table".

Gain

[When [Super Gain] is [Off]: Auto, 0dB to 36dB,

When [Super Gain] is [On]: Auto, 0dB to 42dB]

The image gain is adjusted here.

In locations which are too dark, adjust the gain upward; conversely, in locations which are too bright, adjust it downward.

When [Auto] is set, the light quantity is adjusted automatically.

The noise increases when the gain is increased.

Factory settings: Refer to the "Camera menu item table".

Super Gain [Off, On]

Set the super gain (increased sensitivity) mode.

Off	Do not set super gain mode.
On	Set super gain mode.

Factory settings: Refer to the "Camera menu item table".

AGC Max Gain [6dB, 12dB, 18dB, 24dB, 30dB, 36dB]

When [Auto] is selected as the [Gain] setting, the maximum gain-up amount can be set.

Factory settings: Refer to the "Camera menu item table".

Frame Mix [Auto, Off, 6dB, 12dB, 18dB, 24dB]

Select for frame addition (gain-up using sensor storage) amount.

When frame addition is performed, it will appear as if the images are missing some frames.

When [Shutter Mode] is [ELC], you can set only [Auto] or [Off].

This cannot be set when [Shutter Mode] is [Step] or [Synchro].

This cannot be configured when the format is 2160/29.97p, 2160/23.98p, 2160/24p, 2160/25p, 1080/29.97p, 1080/23.98p(59.94i), 1080/23.98p, 1080/24p, 1080/29.97PsF, 1080/23.98PsF, 1080/25p or 1080/25PsF.

Factory settings: Refer to the "Camera menu item table".

<NOTE>

- Under discharge tube illumination, such as fluorescent and mercury-vapor lights, the brightness may change cyclically, colors may change, and horizontal stripes may flow up and down the image.
- When [Frame Mix] is set to 6dB, 12dB, 18dB or 24dB, if you set [Shutter Mode] to [ELC], [Frame Mix] is changed to [Off].

Auto F.Mix Max Gain [0dB, 6dB, 12dB, 18dB]

Sets the maximum amount of frames that can be added when [Frame Mix] is running in [Auto] mode.

When frame addition is performed in [Auto] mode, it will appear as if the images are missing some frames.

Factory settings: Refer to the "Camera menu item table".

Back Light COMP. [Off, On]

Turn the backlight compensation function On/Off.

The camera compensates to make the overall screen brighter to

reduce the effect of the subject darkening due to backlight.

This is enabled when the following automatic exposure compensation functions are set to either [Auto] or [ELC].

- When [Iris Mode] is set to [Auto]
- When [Shutter Mode] is set to [ELC]
- When [Gain] is set to [Auto]
- When [Frame Mix] is set to [Auto]

<NOTE>

- When [Spot Light COMP.] is set to [On], [Back Light COMP.] is [Off].

Factory settings: Off

Spot Light COMP. [Off, On]

Turn the spotlight compensation function On/Off.

The camera compensates to shoot bright subjects cleanly when something like a spotlight makes the center extremely bright.

This is enabled when the following automatic exposure compensation functions are set to either [Auto] or [ELC].

- When [Iris Mode] is set to [Auto]
- When [Shutter Mode] is set to [ELC]
- When [Gain] is set to [Auto]
- When [Frame Mix] is set to [Auto]

<NOTE>

- When [Back Light COMP.] is set to [On], [Spot Light COMP.] is [Off].

Factory settings: Off

Flicker Suppression [Off, On]

Turn the flicker suppression function On/Off.

The light that is generated under discharge tubes (such as fluorescent lights) changes cyclically and produces a flickering effect, and this function can reduce these issues that produce horizontal stripes in colors.

Factory settings: Off

Web screen configurations (continued)

ND Filter [Through, 1/4, 1/16, 1/64, Auto]

Set the transmittance of the lens' built-in ND (neutral density) filter. The filter switches when the setting is fixed.

Through	Do not set ND filter.
1/4	Set ND filter transmittance to 1/4.
1/16	Set ND filter transmittance to 1/16.
1/64	Set ND filter transmittance to 1/64.
Auto	The transmittance of the ND filter is automatically adjusted to one of [Through], [1/4], [1/16], or [1/64]. This can only be set when [Scene] is [Full Auto].

Factory settings: Through

Day/Night [Day, Night]

Switch between standard shooting and night-vision shooting (shooting with infrared light).

Day	Standard shooting (day mode)
Night	Night-vision shooting (night mode)

Factory settings: Day

<NOTE>

- In night mode, video output will be in black and white. In addition, the iris will be forcibly opened.
- White balance adjustment is not possible in night mode.
- ND filter switching is not possible in night mode.
- [Pedestal] cannot be performed properly in night mode.

Picture

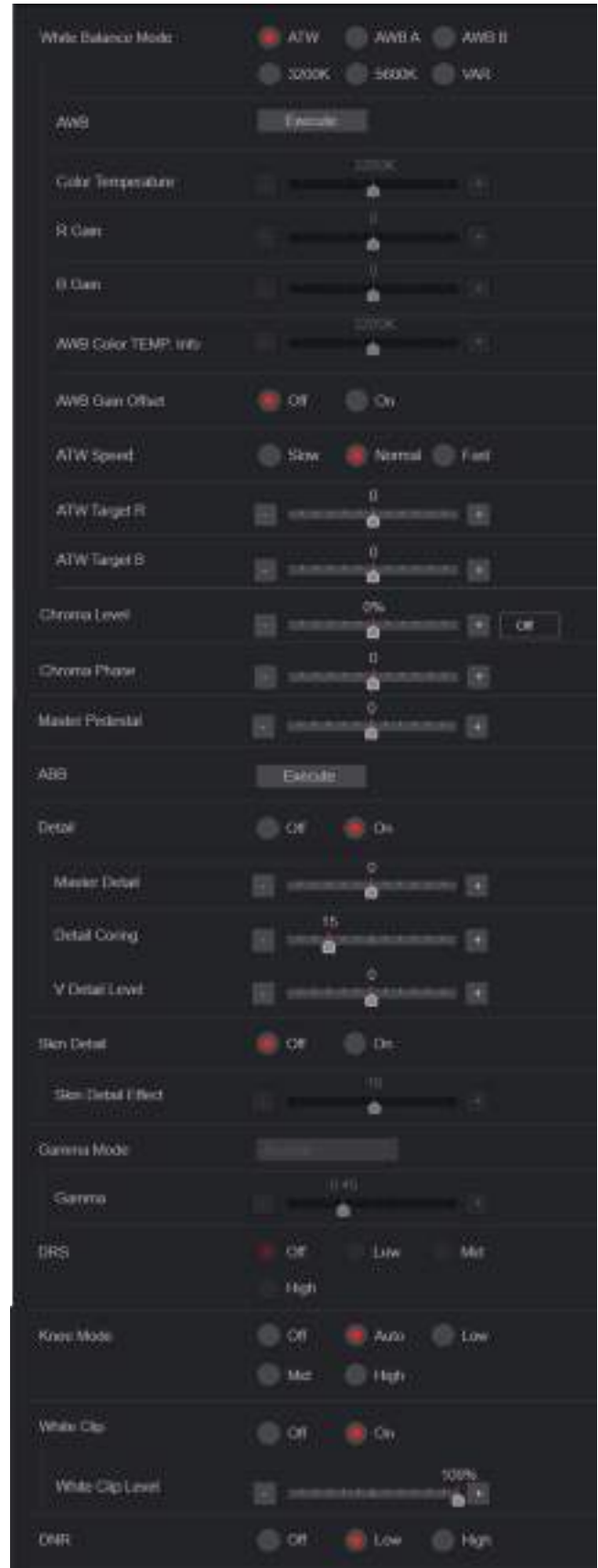

White Balance Mode

[ATW, AWB A, AWB B, 3200K, 5600K, VAR]

Set the white balance mode.

Select the mode when the coloring is not natural because of the nature of the light source or other factors.

If the white color serving as the reference can be recognized, subjects can be shot with natural coloring.

ATW	In this mode, the white balance is compensated for automatically, even if changes occur in the light source or color temperature, by a process of continuous and automatic adjustment.
AWB A AWB B	When [AWB A] or [AWB B] is selected and the white balance is executed, the adjustment results obtained are stored in the memory selected. When [AWB A] or [AWB B] is then selected, the white balance stored in the selected memory can be recalled.
3200K	This is the white balance mode which is ideal when a 3200K halogen light is used as the light source.
5600K	This is the white balance mode which is ideal when 5600K sunlight or fluorescent lighting is used as the light source.
VAR	You can specify a color temperature between 2000K to 15000K.

Factory settings: Refer to the "Camera menu item table".

AWB

When the [Execute] button is clicked, automatic white balance (AWB) is executed and the white balance is reset.

Its setting takes effect when [AWB A] or [AWB B] has been selected as the [White Balance Mode] setting.

Color Temperature [2000K to 15000K]

You can specify a color temperature between 2000K to 15000K.

Its setting takes effect when [VAR] has been selected as the [White Balance Mode] setting.

Factory settings: 3200K

R Gain [-200 to +200]

This enables the R gain to be adjusted.

Its setting takes effect when [AWB A], [AWB B] or [VAR] has been selected as the [White Balance Mode] setting.

Factory settings: 0

B Gain [-200 to +200]

This enables the B gain to be adjusted.

Its setting takes effect when [AWB A], [AWB B] or [VAR] has been selected as the [White Balance Mode] setting.

Factory settings: 0

AWB Color TEMP. Info [2000K to 15000K]

This displays the color temperature when [White Balance Mode] is [AWB A] or [AWB B]. (reference only)

Its setting takes effect when [AWB A] or [AWB B] has been selected as the [White Balance Mode] setting.

AWB Gain Offset [Off, On]

When auto white balance is performed by setting [White Balance Mode] to [AWB A] or [AWB B], set the values for Rch gain and Bch gain.

Off	Set the value of [R Gain] and [B Gain] to [0].
On	Maintain the value set in [R Gain] and [B Gain].

Factory settings: Off

ATW Speed [Slow, Normal, Fast]

Set the control speed of the ATW function.

Slow	Tracks at a speed slower than [Normal].
Normal	Tracks at normal speed.
Fast	Tracks at a speed faster than [Normal].

This is only enabled when [White Balance Mode] is set to [ATW].

Factory settings: Normal

ATW Target R [-10 to +10]

Make fine adjustments to the Rch output when converging with the auto tracking white balance operation.

This is only enabled when [White Balance Mode] is set to [ATW].

Factory settings: 0

ATW Target B [-10 to +10]

Make fine adjustments to the Bch output when converging with the auto tracking white balance operation.

This is only enabled when [White Balance Mode] is set to [ATW].

Factory settings: 0

Chroma Level [Off, -99% to 99%]

Set here the color intensity (chroma level) of the images.

Factory settings: 0%

Chroma Phase [-31 to +31]

Make fine adjustments to the hue of the colors in the images.

Factory settings: 0

ABB

When the [Execute] button is clicked, automatic black balance (ABB) is executed and the black balance is reset.

Master Pedestal [-200 to +200]

This item is used to adjust the black level (adjust the pedestal).

These parts become darker when a negative setting is selected and, conversely, lighter when a positive setting is selected.

Factory settings: 0

Detail [Off, On]

Turn on/off the contour (sharpness of images) adjustment of images.

Factory settings: On

Master Detail [-31 to +31]

Adjust the contour correction level (master).

This is only enabled when [Detail] is set to [On].

Factory settings: 0

Detail Coring [0 to 60]

Set the level of the signal (including noise) which makes the detail effect not work.

This is only enabled when [Detail] is set to [On].

Factory settings: 15

V Detail Level [-7 to +7]

Adjust the contour correction level in the vertical direction.

This is only enabled when [Detail] is set to [On].

Factory settings: 0

Web screen configurations (continued)

Skin Detail [Off, On]

This function smooths skin and produces a more beautiful image.

This is only enabled when [Detail] is set to [On].

Factory settings: Off

Skin Detail Effect [0 to 31]

The skin of human subjects appears smoother the larger the setting value.

This is only enabled when [Detail] is set to [On] and [Skin Detail] is set to [On].

Factory settings: 16

Gamma Mode

[Normal, HD, Cinema1, Cinema2, Still Like]

Select the type of gamma curve.

Normal	Standard gamma characteristic.
HD	HD (High Definition) video gamma characteristic.
Cinema1	High contrast gamma characteristic.
Cinema2	Sedate gamma characteristic.
Still Like	Sets the gamma characteristics for a digital still camera image tone.

Factory settings: Normal

Gamma [0.30 to 0.75]

Adjust the gamma correction level.

Specifying smaller values results in a gentler gamma curve for the slope of low-brightness areas and sharper contrast.

Specifying larger values results in an expanded gradient for dark areas and produces brighter images. The gamma curve for low-brightness areas will be steeper, and contrast will be softer.

Factory settings: 0.45

DRS [Off, Low, Mid, High]

Set the DRS function which performs correction when video with high light/dark contrast is displayed.

You can select from a [Low], [Mid], or [High] effect level.

Factory settings: Off

Knee Mode [Off, Auto, Low, Mid, High]

Set the operating mode for gradation compression (knee).

Off	Turn the knee function off.
Auto	Enable the knee function, and set the knee point and knee slope automatically.
Low, Mid, High	Enable the knee function, and manually set the knee point and knee slope in three steps.

Factory settings: Auto

<NOTE>

- When [DRS] is enabled, the knee setting is disabled.

White Clip [Off, On]

Turn the white clip function off/on.

Factory settings: On

White Clip Level [90% to 109%]

Set the white clip level.

This is only enabled when [White Clip] is set to [On].

Factory settings: 109%

<NOTE>

- When [Knee Mode] is set to [Auto] and the value of [White Clip Level] is changed, the knee value will also change.

DNR [Off, Low, High]

Set the digital noise reduction level for outputting bright, clear images without noise, even at night and low-light conditions.

When [Low] or [High] is selected, noise can be eliminated.

However, image lag may increase.

Factory settings: Low

● Matrix



Matrix Type [Normal, Professional, User]

Select the type of color matrix.

The setting is confirmed with the [Set] button.

Normal	Standard preset matrix setting.
Professional	Preset matrix setting equivalent to Panasonic broadcasting devices.
User	On the [Matrix 2/5] screen, the [Linear Matrix] value can be adjusted by the user. On the [Matrix 3/5] screen, [Matrix 4/5] screen or [Matrix 5/5] screen, the [Color Correction] value can be adjusted by the user.

Factory settings: Normal

Adaptive Matrix [Off, On]

Set Off/On the function that suppresses the linear matrix to suit the shooting conditions.

Factory settings: Off

Matrix Settings

Linear Matrix

This can be set when [User] has been selected as the [Matrix Type] setting.

R-G	Adjust the color to between -63 and +63 for each axis direction.
R-B	
G-R	
G-B	
B-R	
B-G	

Factory settings: (→ page 78)

Color Correction

This can be set when [User] has been selected as the [Matrix Type] setting.

Adjust the saturation and hue for each color.

Saturation [-63 to +63]

Adjust the saturation for each color.

Phase [-63 to +63]

Adjust the hue for each color.

B_Mg	Color between blue and magenta
Mg	Magenta
Mg_R	Color between magenta and red
Mg_R_R	Color with a 1:3 magenta to red ratio
R	Red
R_R_Yl	Color with a 3:1 red to yellow ratio
R_Yl	Color between red and yellow
R_Yl_Yl	Color with a 1:3 red to yellow ratio
Yl	Yellow
Yl_Yl_G	Color with a 3:1 yellow to green ratio
Yl_G	Color between yellow and green
G	Green
G_Cy	Color between green and cyan
Cy	Cyan
Cy_B	Color between cyan and blue
B	Blue

Factory settings: (→ page 78)

■ Lens setting screen [Lens]

The setting is confirmed with the [Set] button.

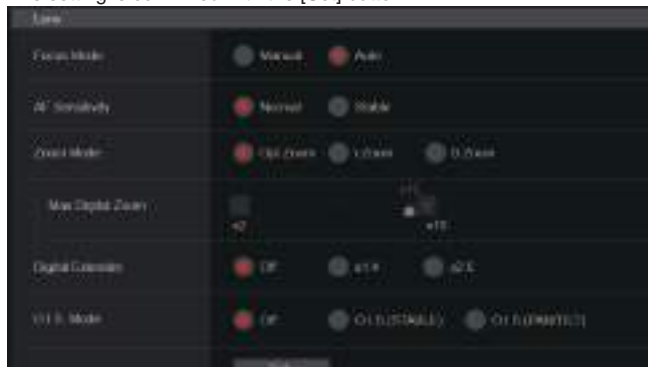

Focus Mode [Manual, Auto]

Select auto or manual mode for the focus adjustment function.

Manual	Adjust focus manually.
Auto	Always adjust focus automatically.

Factory settings: Auto

AF Sensitivity [Normal, Stable]

Select the conformability mode for auto focusing function.

Normal	Focusing is with a standard conformability.
Stable	Focusing is with a priority placed on stability.

Factory settings: Normal

Zoom Mode [Opt.Zoom, i.Zoom, D.Zoom]

Set the maximum magnification rate for zoom.

Opt.Zoom	Use only optical zoom. Optical zoom up to 24x is possible.
i.Zoom	Enable the i.Zoom function. When this function is enabled, digital zoom is used while reducing image degradation. When [Format] in the [System] screen is 2160/29.97p, 2160/25p, 2160/24p, 2160/23.98p Up to 28x zoom is possible combining optical zoom and digital zoom. • When [Format] in the [System] screen is other than one of these, up to 36x zoom is possible combining optical zoom and digital zoom.
D.Zoom	Enable the digital zoom function. Higher digital zoom magnifications will result in coarser images.

Factory settings: Opt.Zoom

Max Digital Zoom

[×2, ×3, ×4, ×5, ×6, ×7, ×8, ×9, ×10]

Set the maximum digital zoom magnification.

This is only enabled when [Zoom Mode] is set to [D.Zoom].

Factory settings: ×10

<NOTE>

- Higher digital zoom magnifications will result in coarser images.

Digital Extender [Off, ×1.4, ×2.0]

Make settings for the digital extender function.

Off	Turn the digital extender function off.
×1.4	The digital zoom will be fixed at 1.4x.
×2.0	The digital zoom will be fixed at 2.0x.

This is only enabled when [Zoom Mode] is set to [Opt.Zoom].

Factory settings: Off

O.I.S. Mode

[Off, O.I.S.(STABLE), O.I.S.(PAN/TILT)]

Sets the mode for optical image stabilization (O.I.S.).

Off	Turns the optical image stabilization (O.I.S.) function and electronic image stabilization (EIS) function Off.
O.I.S. (STABLE)	Turns the optical image stabilization (O.I.S.) function and roll direction electronic image stabilization (EIS) function On. Use with a pan/tilt fixed shooting scene.
O.I.S. (PAN/TILT)	Turns the optical image stabilization (O.I.S.) function and roll direction electronic image stabilization (EIS) function On. Use with a scene for increasing the image stabilization effect during a shooting while performing the pan/tilt operation.

Factory settings: Off

<NOTE>

- In [O.I.S.(STABLE)] mode, the optical image stabilization (O.I.S.) function's level of correction is reduced during pan/tilt operations in order to minimize the convergence resulting from image stabilization during pan/tilt operations.
- In [O.I.S.(PAN/TILT)] mode, as importance is given to heighten the image stabilization effect during pan/tilt operations, the convergence resulting from image stabilization during pan/tilt control may be a cause for concern in some scenes.
Use [O.I.S.(STABLE)] for scenes where the convergence resulting from image stabilization needs to be restrained.

■ Preset position screen [Preset position]



● Preset

The setting is confirmed with the [SET] button.



	<p>When a preset thumbnail is clicked, the camera moves to face towards a preset position that was registered beforehand. You can select Home and Preset001 to Preset100. Preset numbers are displayed in green when they have had a preset position registered in them.</p>
<p>Preset001 (Preset name)</p>	<p>Preset names are displayed. During the preset registration mode, you can select a preset name and change the display name. You can enter between 1 to 15 characters. The characters available are 0 to 9, A to Z, a to z, spaces, and underscores (_).</p>
<p>1 2 3 4 5 6 7 8 9 10 11 12</p>	<p>Switches the page of the displayed preset thumbnails.</p>
<p>Home [Home]</p>	<p>Move to home position.</p>
<p>SET [SET]</p>	<p>The unit moves to the preset registration mode. When a preset thumbnail is clicked in the preset registration mode, it is registered in the preset position specified by the current condition.</p>
<p>DEL [DEL]</p>	<p>The unit moves to the preset delete mode. When a preset thumbnail is clicked in the preset delete mode, the specified preset position settings are deleted.</p>
<p>[Save]</p>	<p>Acquire JPEG images (still images) and save them. They can be saved by specifying [PICT001] to [PICT100] or [STIL001] to [STIL005] in the save destination. If [PICT***] is selected, the thumbnail image for the corresponding preset number can be updated, and if [STIL001] to [STIL005] is selected, you can save still images with a higher resolution. Furthermore, when [STIL001] to [STIL005] have been selected, the [Load] and [DEL] buttons are activated and it is possible to load and delete the still images you have saved.</p>

● Limitation Setting

This establishes the up, down, left and right limit settings of the pan-tilt head.

First, use the control pad to rotate the pan-tilt head to the position you want to set as the limit.

After the limit position has been selected, click the buttons corresponding to the following items to confirm.

The setting is cleared if the button is pressed again.

Tilt Up	Use this to save the current position as the upward limit.
Tilt Down	Use this to save the current position as the downward limit.
Pan Left	Use this to save the current position as the leftward limit.
Pan Right	Use this to save the current position as the rightward limit.

● Pan/Tilt Lens Control

This is used for camera control. The same operations are possible as with the camera controller operated in the live screen [Live].

(→ page 89)

Speed With Zoom Position [Off, On]

[Off] or [On] is set here for the function used to adjust the pan-tilt adjustment speed in conjunction with the zoom magnification.

When [On] is set, the panning and tilting operations will become slower in the zoom status.

This function has no effect during preset operations.

Factory settings: On

Focus Adjust With PTZ. [Off, On]

[Off] or [On] is set here for the function which compensates for out-of-focusing when it occurs during panning, tilting or zooming operations.

When [Off] is set, adjust the focus as required after zooming or set [Focus Mode] to [Auto].

This is only enabled when [Manual] has been selected as the [Focus Mode] setting.

Factory settings: Off

● Preset Setting

Preset Speed Unit [Speed Table, Time]

When reproducing the information such as camera direction registered in the preset memory, you can select whether to specify the playback time by speed or by time.

Speed Table	Specify the speed when playing during preset playback.
Time	Specify the time when playing during preset playback.

Factory settings: Speed Table

Preset Speed Table [Slow, Fast]

Set the preset speed table (Slow, Fast). During preset playback, presets are performed at [Preset Speed] (1 to 30) values that are based on the table set here.

This is only enabled when [Preset Speed Unit] is set to [Speed Table].

Factory settings: Fast

Preset Speed [1 to 30/1s to 99s]

When [Preset Speed Unit] is [Speed Table]: [1 to 30]

Set the pan/tilt operation speed in 30 steps when playing back the preset memory.

Factory settings: 20

<NOTE>

- When you set large [Preset Speed] values, the image may sway when the movement stops.

When [Preset Speed Unit] is [Time]: [1s to 99s]

Set the pan/tilt operation time between 1 and 99 seconds when playing back the preset memory.

Factory settings: 20s

<NOTE>

- Depending on the movement distance of pan/tilt, there may be a difference compared to the specified time.

Preset Acceleration [Manual, Auto]

Sets whether to perform advance setting for acceleration and deceleration speed etc. during start/stop of preset playback.

Manual	Makes the advance settings for acceleration speed etc. when starting/stopping preset playback.
Auto	Automatically operates acceleration speed etc. when starting/stopping preset playback.

Factory settings: Auto

Rise S-Curve [0 to 30]

Sets the S-curve for pan/tilt acceleration operation in 31 steps. (The S becomes stronger, the greater the number)

During the acceleration operation for operating at the specified speed or time during pan/tilt operations by preset playback, the acceleration process is performed using the S-curve specified in this setting.

This is enabled only when [Preset Acceleration] is [Manual].

Factory settings: 15

<NOTE>

- In order to limit the acceleration response, in the S-curve step, as the acceleration speed rises, the limit is automatically applied.

Fall S-Curve [0 to 30]

Sets the S-curve for pan/tilt deceleration operation in 31 steps. (The S becomes stronger, the greater the number)

During the fall acceleration operation for operating at the specified speed or time during pan/tilt operations by preset playback, the deceleration process is performed using the S-curve specified in this setting.

This is enabled only when [Preset Acceleration] is [Manual].

Factory settings: 15

<NOTE>

- In order to limit the deceleration response, in the S-curve step, as the deceleration speed rises, the limit is automatically applied.

Rise Acceleration [1 to 255]

Sets the acceleration speed for pan/tilt acceleration operation in 255 steps. (The acceleration speed increases as the number increases) During the acceleration operation for operating at the specified speed or time during pan/tilt operations by preset playback, the acceleration process is performed using the acceleration speed specified in this setting.

This is enabled only when [Preset Acceleration] is [Manual] and [Preset Speed Unit] is [Speed Table].

Factory settings: 128

<NOTE>

- As the speed specified for [Preset Speed] is given priority as the maximum speed attained in preset playback, if the acceleration speed specified here is small, this functionality may not operate as specified.

Fall Acceleration [1 to 255]

Sets the deceleration speed for pan/tilt deceleration operation in 255 steps. (The deceleration speed increases as the number increases) During the deceleration operation for operating at the specified speed or time during pan/tilt operations by preset playback, the deceleration process is performed using the deceleration speed specified in this setting.

This is enabled only when [Preset Acceleration] is [Manual] and [Preset Speed Unit] is [Speed Table].

Factory settings: 128

<NOTE>

- As the speed specified for [Preset Speed] is given priority as the maximum speed attained in preset playback, if the deceleration speed specified here is small, this functionality may not operate as specified.

Rise Ramp Time [0.1s to 10.0s]

Sets the acceleration time for the time specific operation during preset playback. (Sets between 0.1 s to 10.0 s in 0.1s increments)

This is enabled only when [Preset Acceleration] is [Manual] and [Preset Speed Unit] is [Time].

Factory settings: 0.1s

<NOTE>

- As the time specified in [Preset Speed] takes precedence as the total time for preset playback, if the time specified here is more than half of the time specified in [Preset Speed], this functionality will not operate as specified.
- When the acceleration operation cannot be performed within the specified time even at maximum acceleration speed of the device, the operation will not be performed by the specified time.

Fall Ramp Time [0.1s to 10.0s]

Sets the deceleration time for time specified operations during preset playback. (Sets between 0.1 s to 10.0 s in 0.1 s increments)

This is enabled only when [Preset Acceleration] is [Manual] and [Preset Speed Unit] is [Time].

Factory settings: 0.1s

<NOTE>

- As the time specified in [Preset Speed] takes precedence as the total time for preset playback, if the time specified here is more than half of the time specified in [Preset Speed], this functionality will not operate as specified.
- When the deceleration operation cannot be performed within the specified time even at maximum fall deceleration of the device, the operation will not be performed by the specified time.

Preset Scope [Mode A, Mode B, Mode C]

Selected here are the setting items to be recalled when the contents of the preset memory are regenerated.

Mode A	Pan, Tilt, Zoom (including digital zoom), Focus, Iris, Gain, white balance adjustment value
Mode B	Pan, Tilt, Zoom (including digital zoom), Focus, Iris
Mode C	Pan, Tilt, Zoom (including digital zoom), Focus

Factory settings: Mode A

Preset Digital Extender [Off, On]

Turns the preset digital extender function off/on.

When set to [On], the digital extender function configuration will be recalled when regenerating the preset memory.

When set to [Off], the digital extender function configuration will not be recalled when storing the preset memory.

Factory settings: Off

Preset Thumbnail Update [Off, On]

Turn off/on the function for registering the still image (thumbnail) for the images being output when a preset memory is registered.

When set to [On], the still image (thumbnail) for the images being output is registered when registering a preset memory.

When set to [Off], the still image (thumbnail) for the images being output is not registered when registering a preset memory, but rather the still image (thumbnail) previously registered is maintained.

Factory settings: On

<NOTE>

- When [IP/HDI|HX] of [OSD Mix] is [On], the character strings of OSD menu displayed during the generation of still images (thumbnails) and crop frames are imported to the thumbnails.
- When uploading Camera(ALL), Camera(SYSTEM) or Camera(PRESET) on the web screen or other access, the still image (thumbnail) that has been registered in preset memory will be erased. (→ page 146)

Preset Name [Reset, Hold]

When registering a preset memory, set whether to reset the previously registered preset name or keep it.

Reset	When registering a preset memory, reset the previously registered preset name. The preset name after resetting will be [Preset***]. (***) is a 3 digit preset number: 001 to 100)
Hold	When registering a preset memory, keep the previously registered preset name.

Factory settings: Reset

<NOTE>

- The factory default setting for the preset name is [Preset***]. (***) is a 3 digit preset number: 001 to 100)
- The registration of preset names can be done in the web browser. 0 to 9, A to Z, a to z, _ , and space

Preset Iris [Off, On]

When the preset memory is played back, set whether the reproduction of the values in the various menus related to Iris is off/on.

When set to [On], the values set in the various menus below are reproduced when preset memory is played back.

- Picture Level
- Iris Mode
- Auto Iris Speed
- Auto Iris Window

Factory settings: Off

<NOTE>

- Its setting takes effect when [Mode A] or [Mode B] has been selected as the [Preset Scope] setting.

Preset Shutter [Off, On]

When the preset memory is played back, set whether the reproduction of the Shutter setting value is Off/On.

Factory settings: On

<NOTE>

- This is enabled when [Preset Scope] is [Mode A].
- The Shutter values are reproduced only when the frame rate when the preset memory was registered and the frame rate when playing back the preset memory match.

Preset Zoom Mode [Mode A, Mode B]

Select the zoom operation for when preset memory is recalled.

Mode A	Perform the zoom operation in line with the pan/tilt operation.
Mode B	Perform the zoom operation quicker than the pan/tilt operation.

Factory settings: Mode A

Freeze During Preset [Off, On]

Turn the function for freezing images during preset playback off/on.

When this is set to [On], preset playback is performed with a still of the image immediately preceding the start of preset playback being output. The image freeze is released when preset playback is finished.

Factory settings: Off

Collaboration capability [Linkage]

Tracking data output settings screen [Tracking Data Output]

Select the output mode of the tracking data and the communication destination in the IP mode.

Up to four addresses can be specified when the IP mode is enabled.

● Setting status

Displays the output mode of tracking data and the destinations in IP mode.



● Connection type



Serial [On, Off]

Sets the function [On] or [Off] to output the tracking data, such as Pan/Tilt/Zoom or other information from Serial Output (RS-422), synchronized with the Genlock signal. (→ page 59)

When [Serial] is set to [On], a warning message is displayed. Click the [OK] button to enable the settings.

Factory settings: Off

<NOTE>

- The serial connection of the remote controller (AW-RP150 or AW-RP60 etc.) cannot be made if [Serial] is already [On].
- In the following cases, the tracking data output may be delayed or the value may not be updated.
 - While viewing the OSD menu
 - While recalling the preset value during an ongoing preset recall
 - When executing AWB/ABB
 - When a red or a green tally signal input has been changed between Off and On
 - When deleting a preset memory
 - When an output image is flipped (turned upside down or left-right reversed)
 - After switching [Scene]
 - After switching [Iris Mode]
 - After switching [Super Gain]
 - After switching [White Balance Mode]
 - After switching [Gamma Mode]
 - After switching [Matrix Type]
 - After switching [Focus Mode]
 - After switching [Zoom Mode]
 - After switching [Max Digital Zoom]
 - After switching [Digital Extender]
 - After switching [Fan]
 - After switching [OSD Mix]
 - After switching [Tally]
 - After switching [Install Position]

- After switching [Preset Speed Unit]
- When executing [Reset to the default (Except the network settings)] of [Maintenance]

IP(UDP) [On, Off]

Sets the UDP output function [On] or [Off] to output tracking data, such as Pan/Tilt/Zoom or other information from the IP output, synchronized with the Genlock signal. (→ page 60)

When [IP(UDP)] is set to [On], a warning message is displayed. Click the [OK] button to enable the settings.

Factory settings: Off

<NOTE>

- When [IP(UDP)] is [On], video transmission via IP may be delayed or the video may suffer frame loss.
We recommend setting [IP(UDP)] to [Off] to avoid the delay or frame loss due to the video transmission via IP.
- In the following cases, the tracking data output may be delayed or the value may not be updated.
 - When performing video transmission via IP (M-JPEG/H.264/H.265/RTMP/RTMPS/NDI/NDI|HX/SRT)
 - When opening the web screen (live screen [Live] or the web setting screen [Setup])
 - While viewing the OSD menu
 - While recalling the preset value during an ongoing preset recall
 - When executing AWB/ABB
 - When a red or a green tally signal input has been changed between Off and On
 - When deleting a preset memory
 - When an output image is flipped (turned upside down or left-right reversed)
 - After switching [Scene]
 - After switching [Iris Mode]
 - After switching [Super Gain]
 - After switching [White Balance Mode]
 - After switching [Gamma Mode]
 - After switching [Matrix Type]
 - After switching [Focus Mode]
 - After switching [Zoom Mode]
 - After switching [Max Digital Zoom]
 - After switching [Digital Extender]
 - After switching [Fan]
 - After switching [OSD Mix]
 - After switching [Tally]
 - After switching [Install Position]
 - After switching [Preset Speed Unit]
- When executing [Reset to the default (Except the network settings)] of [Maintenance]

Invert Pan/Tilt Axis [Off, On]

Sets whether to invert the Pan/Tilt data for output in the tracking data.

Off	Pan/Tilt data is not inverted.
On	Pan/Tilt data is inverted for output.

Factory settings: Off

● IP out



Output client select [Client 1 to 4]

Enable or disable up to four clients to forward the tracking data when [IP(UDP)] is [On].

Forwards the tracking data via UDP such as Pan/Tilt/Zoom or other information to the clients that are set to enable on this screen.

The setting is confirmed with the [Set] button.

Factory settings:

- Client1: Disable
- Client2: Disable
- Client3: Disable
- Client4: Disable

<NOTE>

- Disable the client that does not require the forwarding of the tracking data because the UDP packet is transmitted to the enabled client at the system frequency interval.
- When multiple clients are enabled, the timing of transmitting the UDP packet to the second and subsequent clients will always be delayed relative to the Genlock signal.
(Approximately 200 to 300 μ s delay will occur for each client. The latency may be increased depending on the system status or the network environment of the unit.)

Client1 to 4

IP address(IPv4)

Sets the destination IP address to forward the tracking data such as Pan/Tilt/Zoom or other information via UDP.

The setting is confirmed with the [Set] button.

Factory settings:

- Client1: 192.168.0.111
- Client2: 192.168.0.112
- Client3: 192.168.0.113
- Client4: 192.168.0.114

<NOTE>

- The address to forward the tracking data can only be configured as IPv4.
- A multicast address cannot be specified for the destination address.

Port

Sets the destination port number to forward the tracking data such as Pan/Tilt/Zoom or other information via UDP.
 The setting is confirmed with the [Set] button.
 The following port numbers are used by the unit so they cannot be used.
 20, 21, 23, 25, 42, 53, 67, 68, 69, 80, 110, 123, 161, 162, 443, 554, 995, 10669, 10670, 59000 to 61000

Factory settings:

- Client1: 1111
- Client2: 1112
- Client3: 1113
- Client4: 1114

<NOTE>

- You cannot set up clients having a combination of two or more IP addresses with duplicated ports.

■ P2 Cast connection setting screen [P2 Cast]

Sets whether to enable or disable connection to P2 Cast, as well as the destination server URL and the user account.
 The setting is confirmed with the [Set] button.

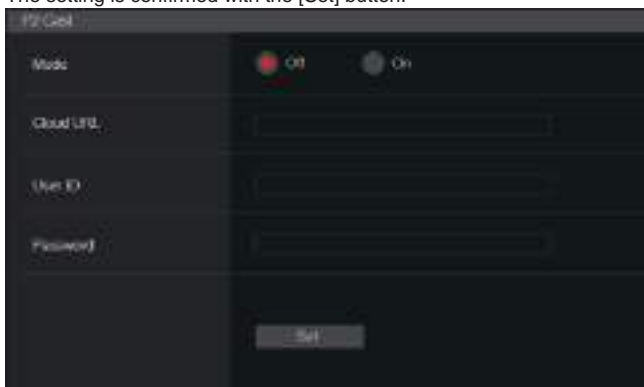

Mode [On, Off]

Sets whether to connect this unit to P2 Cast via a network.

Factory settings: Off

Cloud URL

Sets the server URL of P2 Cast to be connected when [Mode] is [On].

<NOTE>

- You can set the URL with maximum 512 characters.

User ID

Sets the user ID for connection to P2 Cast when [Mode] is [On].

Password

Sets the password for connection to P2 Cast when [Mode] is [On].

User management screen [User mng.]

The users and personal computers (IP addresses) that can access the unit from personal computers and mobile terminals are registered in the User management screen [User mng.].
 The User management screen [User mng.] consists of [User auth.] and [Host auth.].

■ User authentication screen [User auth.]

Click the [User auth.] of User management screen [User mng.].
 Configure the user authentication settings for the personal computers and mobile terminals that can access the unit.
 Up to 9 users can be registered.

<NOTE>

- If user authentication fails more than 8 times within a 30-second period from the same IP address (personal computer), access to the unit will be disabled for a certain period.

● Setting status

The current user authentication settings and user authentication method are displayed. The currently registered account information is also displayed.

Setting status		
User auth.	Authentication	
Off	Digest	
	User name	Access level
1.	admin	Administrator

● Mode

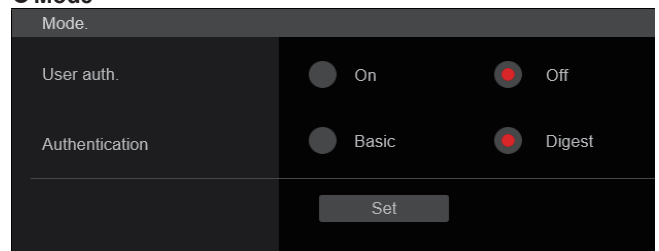

User auth. [On, Off]

User authentication is set to [On] or [Off] here.

The setting is confirmed with the [Set] button.

Factory settings: Off

Authentication [Basic, Digest]

Specify the method of user authentication to use.

The setting is confirmed with the [Set] button.

Basic	Use basic authentication.
Digest	Use digest authentication.

Factory settings: Digest

● Add user

User name [1 to 32 characters]

The user name is input here.

The setting is confirmed with the [Set] button.

- The following characters can be displayed.

Numeric characters	0123456789
Alphabetical characters (upper and lower cases)	ABCDEFGHIJKLMNOPQRSTUVWXYZabcdefghijklmnopqrstuvwxyz
Symbols	!\$%&'()*+,-./=:?@[]^_`{ }~

Password

Retype password [4 to 32 characters]

The password is input here.

The setting is confirmed with the [Set] button.

Access level [1.Administrator, 2.Camera control]

Select the user access level.

The setting is confirmed with the [Set] button.

1.Administrator	This access level allows the user to perform all the unit's operations.
2.Camera control	This access level allows only live screen [Live] operations to be performed.

Factory settings: 1.Administrator

● Delete user

Delete the user accounts registered in the unit.

You can delete selected users by clicking the [Delete] button at the right.

	User name	Access level	
1.	admin	Administrator	Delete

■ Host authentication screen [Host auth.]

Click the [Host auth.] of User management screen [User mng.].

Configure the host authentication settings that restrict the personal computers (IP addresses) that can access the unit.

● Setting status

Host auth.

The host authentication settings are displayed.

Host IP address

The host IP address is displayed.

Access level

The host access level is displayed.

● Mode

Host auth. [Off, On]

Host authentication is set to [On] or [Off] here.

The setting is confirmed with the [Set] button.

Factory settings: Off

Web screen configurations (continued)

● Add host

IP address

The IP address of the personal computer from which access to the camera is allowed is input here. The host name cannot be input as the IP address.

<NOTE>

- When the "IP address/subnet mask length" is input, the personal computers which are allowed to access the camera can be restricted on a subnet by subnet basis. If, for instance, "192.168.0.1/24" has been input and the [2. Camera control] setting has been selected as the [Access level] setting, the personal computers from "192.168.0.1" to "192.168.0.254" will be able to access the camera at the [2. Camera control] access level.
- When an already registered IP address is input and the [Set] button is clicked, the host information will be overwritten.

Access level [1.Administrator, 2.Camera control]

Select the host access level.

The setting is confirmed with the [Set] button.

1.Administrator	This access level allows the user to perform all the unit's operations.
2.Camera control	This access level allows you to display images and control the unit. The unit cannot be set.

Factory settings: 2.Camera control

● Delete host

Delete the host information registered in the unit.

You can delete selected host information by clicking the [Delete] button at the right.

Network setup screen [Network]

Configure network settings in the Network setup screen. The Network setup screen [Network] consists of [Network] and [Advanced].

■ Network setup screen [Network]

Click the [Network] of the Network setup screen [Network]. The setting is confirmed with the [Set] button.

The following information is required to configure network settings. Consult your network administrator or Internet service provider.

- IP address
- Subnet mask
- Default gateway (when using a gateway server or router)
- HTTP port
- DNS primary and secondary server addresses (when using DNS)

Web screen configurations (continued)

● IPv4 network

DHCP [On, Off]

Select the method in which the IP address is configured.

Factory settings: Off

<NOTE>

- When [DHCP] is set to [On], AW-RP150/AW-RP60's automatic configuration of IP address (AUTO IP) cannot be used.

IP address(IPv4)

Input the unit's IP address here when the DHCP function is not going to be used. Input an address that will not duplicate an existing IP address which has been set for a personal computer or another network camera.

Factory settings: 192.168.0.10

<NOTE>

- Multiple IP addresses cannot be used even when the DHCP function is used. For details on the DHCP server settings, consult your network administrator.

Subnet mask

Input the unit's subnet mask here if the DHCP function is not going to be used.

Factory settings: 255.255.255.0

Default gateway

Input the unit's default gateway if the DHCP function is not going to be used.

Factory settings: 192.168.0.1

<NOTE>

- Multiple IP addresses cannot be used for the default gateway even when the DHCP function is used.
For details on the DHCP server settings, consult your network administrator.

● IPv6 network

Manual [On, Off]

Enable or disable manual configuration of the IPv6 address.

On	Enter the IPv6 address manually.
Off	Disable manual entry of the IPv6 address.

Factory settings: Off

IP address(IPv6)

When [Manual] is set to [On], the IPv6 address must be entered manually.

Be sure to enter an address unique from other devices.

<NOTE>

- When connecting to the manually specified IP address through a router, use an IPv6-compatible router, and enable the automatic configuration function for the IPv6 address. Be sure to configure an IPv6 address that includes the prefix information provided by the IPv6-compatible router. For details, refer to the operating instructions for the router.
- Link local address cannot be set.

Default gateway

When [Manual] is set to [On] for [IPv6 network], enter the default gateway for the unit's IPv6 network.

Factory settings: blank

<NOTE>

- It is not possible to set the default gateway when [DHCPv6] is [On].

DHCPv6 [On, Off]

Enable or disable use of the IPv6 DHCP function.

Configure the DHCP server so that the same IP address is not configured for a personal computer that does not use the DHCP function and other network cameras. For details on server settings, consult your network administrator.

On	Use the IPv6 DHCP function.
Off	Do not use the IPv6 DHCP function.

Factory settings: Off

DNS [Auto, Manual]

Set whether the DNS server address is to be acquired automatically (Auto) or to be manually input (Manual).

The DNS setting needs to be performed if [Manual] is set.

When using the DHCP function, if you set to [Auto], then the DNS server address will be acquired automatically.

Consult the system administrator regarding the settings.

Factory settings: Manual

Primary server address

Secondary server address

Enter the IPv4/IPv6 address of the DNS server.

For details on the IPv4/IPv6 address of the DNS server, consult your system administrator.

● Common (to IPv6/IPv4)

HTTP port [1 to 65535]

Port numbers are allocated separately.

The following port numbers are used by the unit so they cannot be used.

20, 21, 23, 25, 42, 53, 67, 68, 69, 80, 110, 123, 161, 162, 443, 546, 547, 554, 995, 5960 to 5985, 7960 to 8060, 10669, 10670, 11900, 59000 to 61000

Factory settings: 80

Max RTP packet size [Unlimited-1500byte, Limited-1280byte]

Specify whether to limit the size of RTP packets sent from the camera when using RTP to view camera images.

Unlimited-1500byte	Unlimited (1500 byte)
Limited-1280byte	Limited (1280 byte)

Factory settings: Unlimited-1500byte

Normally, it is recommended that the [Unlimited-1500byte] setting be used.

Select [Limited-1280byte] when the packet size of the used communication line is limited. For details on the maximum packet size of communication lines, consult your network administrator.

HTTP max segment size (MSS) [Unlimited(1460byte), Limited(1280byte), Limited(1024byte)]

Select whether to limit the maximum segment size (MSS) transmitted by a camera when viewing camera images using HTTP.

Unlimited(1460byte)	Unlimited (1460 byte)
Limited(1280byte)	Limited (1280 byte)
Limited(1024byte)	Limited (1024 byte)

Factory settings: Unlimited(1460byte)

Normally, it is recommended that the default setting be used. Select [Limited(1024byte)]/[Limited(1280byte)] when the maximum segment size (MSS) of the used communication line is limited. For details on the maximum segment size (MSS) of communication lines, consult your network administrator.

Easy IP Setup accommodate period [20min, Unlimited]

Select [20min] or [Unlimited] as the time for enabling the operation of the network settings from the Easy IP Setup Software.

20min	The setting operations from the Easy IP Setup Software are enabled for 20 minutes after the camera has started operating.
Unlimited	The setting operations from the Easy IP Setup Software are enabled at all times.

Factory settings: 20min

<NOTE>

- The camera screen can be opened because the camera display in the Easy IP Setup Software is constantly enabled.
- For details on the address settings of each server, consult your network administrator.
- The port forwarding function converts a global IP address to a private IP address, and includes "static IP masquerade" and "network address translation (NAT)". This function is set to the router.
- To access the camera via the Internet after connecting it to a router, it will be necessary to set an individual HTTP port No. for each network camera and to convert the address using the router's port forwarding function. For details, refer to the operating instructions for the router.

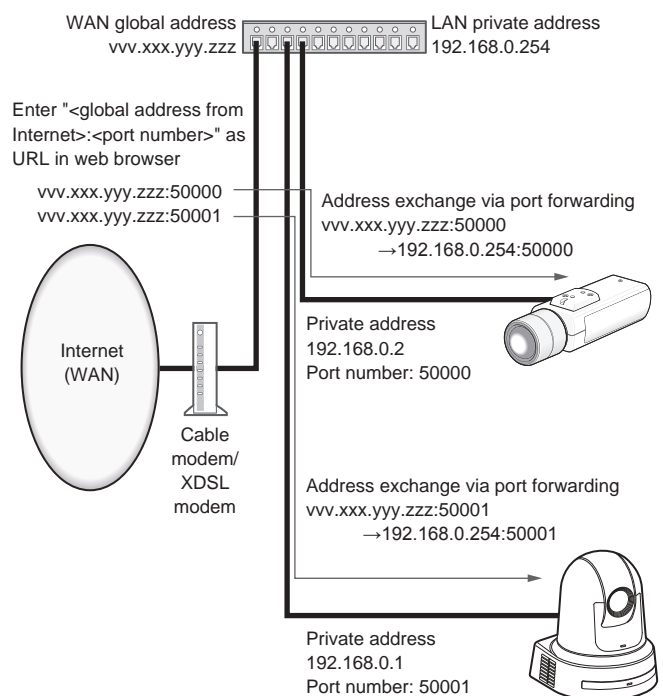

Recommended network setting for internet

Perform the recommended settings to connect the camera to the Internet.

When the [Execute] button is clicked, a dialog box will be displayed. To execute, click the [OK] button.

• [JPEG/H.264] in the Image screen [Image/Audio]

When “Streaming mode” is set to “H.264”

JPEG(1)

Image capture size: 640x360

JPEG(2)

Image capture size: 320x180

JPEG(3)

Off

H.264(1) • H.264(2) • H.264(3) [Windows I.E. 11](#)

Internet mode(Over HTTP): On

Transmission priority: Best effort

H.264(1) [Windows I.E. 11](#)

Image capture size: 1920x1080

Max bit rate(per client): Max8192kbps, Min2048kbps

H.264(2) [Windows I.E. 11](#)

Image capture size: 640x360

Max bit rate(per client): Max4096kbps, Min1024kbps

H.264(3) [Windows I.E. 11](#)

Image capture size: 320x180

Max bit rate(per client): Max4096kbps, Min512kbps

H.264(4) [Windows I.E. 11](#)

H.264 transmission: Off

When “Streaming mode” is set to “H.265”

JPEG(1)

Image capture size: 640x360

JPEG(2)

Image capture size: 320x180

JPEG(3)

Off

H.265(1)

Max bit rate(per client): Max8192kbps

Frame rate: 30fps/25fps/24fps

H.265(2)

Max bit rate(per client): Max4096kbps

Frame rate: 30fps/25fps/24fps

• [Network] in the Network setup screen [Network]

Common IPv6/v4

Max RTP packet size: Limited-1280byte

HTTP max segment size (MSS): Limited(1280byte)

Check active network setting

You can check the information about the Network settings (IPv4, IPv6, DNS) enabled on the unit.

A pop-up window is displayed when you click the [Confirm] button.



<NOTE>

- There is an IP address set manually and an IP address acquired by DHCP displayed for each of [IP address 1(IPv6)] and [IP address 2(IPv6)].

■ Advanced network setting screen [Advanced]

Click the [Advanced] in the network setup screen [Network].
Settings relating to the NTP, UPnP and HTTPS functions are performed here.
Click the links to each item to move to the respective setting page.

● Setting status

Setting status
HTTP Port number
HTTP Status
Disable
HTTPS Port number
HTTPS Status
Disable
Router global address

HTTP Port number

Displays the port number configured via UPnP port forwarding.

HTTP Status

Displays the port forwarding status.

HTTPS Port number

Displays the port number configured via UPnP port forwarding.

HTTPS Status

Displays the port forwarding status.

Router global address

Displays the global address of the router.

● NTP

Settings relating to the NTP server address and port No. are performed here.

The setting is confirmed with the [Set] button.

NTP	
Synchronization with NTP	<input type="radio"/> On <input checked="" type="radio"/> Off
NTP server address setting	Manual
NTP server address	<input type="text"/>
NTP port	<input type="text" value="123"/> (1-65535)
Time adjustment interval	1h
Set	

Synchronization with NTP [On, Off]

On	The time adjusted automatically through synchronization with the NTP server will be used as this unit's standard time.
Off	The time set in [Date/time] of the Basic screen [Basic] will be used as this unit's standard time.

Factory settings: Off

NTP server address setting [Auto, Manual]

Select the method to acquire the NTP server address.

Auto	Acquires the NTP server address from the DHCP server.
Manual	Sets the address by inputting the NTP server address in [NTP server address].

Factory settings: Manual

<NOTE>

- To acquire the NTP server address from the DHCP server, [DHCP] or [DHCPv6] must be set to [On] in the [Network] of the network setup screen [Network]. (→ page 127)

NTP server address

When [Manual] is selected in the [NTP server address setting], input the IP address or host name of the NTP server.

Maximum number of characters	1 to 128 characters
Characters that can be entered	Alphanumeric characters, symbols : . _ -

Factory settings: blank

<NOTE>

- To input the [NTP server address] host name, the [DNS] setting must be selected on the [Network] of the network setup screen [Network]. (→ page 126)
- This does not work when link local address is set in [NTP server address].

NTP port [1 to 65535]

Input the port No. of the NTP server.

The following port numbers are used by the unit so they cannot be used.

20, 21, 23, 25, 42, 53, 67, 68, 69, 80, 110, 123, 161, 162, 443, 546, 547, 554, 995, 5960 to 5985, 7960 to 8060, 10669, 10670, 11900, 59000 to 61000

Factory settings: 123

Time adjustment interval [1h to 24h]

Selects the interval (1 to 24 hours in 1-hour increments) for acquiring the time from the NTP server.

Factory settings: 1h

● UPnP

This unit supports UPnP (Universal Plug and Play). Using the UPnP function allows the following to be set automatically.

- Sets the router's port forwarding function. (However, a UPnP-compatible router is necessary.)

This setting is useful when accessing the camera from the Internet.

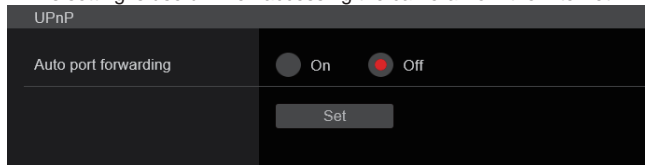

Auto port forwarding [On, Off]

Whether to use the router's port forwarding function is set by selecting [On] or [Off].

To use the automatic port forwarding function, the used router must support UPnP and the UPnP function must be enabled.

The setting is confirmed with the [Set] button.

On	Uses the router's port forwarding function.
Off	The router's port forwarding function is not used.

Factory settings: Off

<NOTE>

- The port number may be changed by automatic port forwarding. If the number is changed, the port No. of the camera registered to the personal computer or recorder must be changed.
- The UPnP function may be used when the camera is connected to the IPv4 network. IPv6 is not supported.
- To confirm that automatic port forwarding is correctly set, click the [Setting status] in the advanced network setting screen [Advanced] to confirm that the [HTTP Status] or [HTTPS Status] is set to [Enable]. (→ page 130)
If [Enable] is not displayed, refer to "Cannot access from a web browser" in the "Troubleshooting" section. (→ page 155)

● HTTPS

Using the HTTPS function enables access to the camera to be encrypted and communication safety to be improved.

The setting is confirmed with the [Set] button.

See page 137 for details on the HTTPS setup method.



CRT key generate

A CRT key (SSL encryption key) is generated by HTTPS.

To generate a CRT key, click the [Execute] button to display the [CRT key generate] dialog.

For details, refer to "Generating a CRT key (SSL encryption key)" (→ page 138).

Self-signed Certificate - Generate

A self-signed security certificate is generated by HTTPS. (Self-signed Certificate)

To generate a self-signed certificate (security certificate), click the [Execute] button to display the [Self-signed Certificate - Generate] dialog and perform the operation.

For details, refer to "Generating a self-signed certificate (security certificate)" (→ page 138).

Self-signed Certificate - Information

This displays information relating to the self-signed certificate (security certificate).

When the [Confirm] button is clicked, the registered content of the generated self-signed certificate (security certificate) is displayed in the [Self-signed Certificate - Confirm] dialog.

Click the [Delete] button to delete the generated self-signed certificate (security certificate).

CA Certificate - Generate Certificate Signing Request

When using a security certificate issued by the Certificate Authority (CA) as a security certificate for HTTPS, a Certificate Signing Request (CSR) is generated for application to the Certificate Authority (CA).

To generate a Certificate Signing Request (CSR), click the [Execute] button to display the [CA Certificate - Generate Certificate Signing Request] dialog and perform the operation.

For details, refer to "Generating a Certificate Signing Request (CSR)" (→ page 139).

CA Certificate - CA Certificate install

This displays information relating to server certificates (security certificates) issued by the Certificate Authority (CA), which are to be or are already installed.

In the [File Open] dialog, which is displayed by clicking the [Select] button, select the file of the server certificate (security certificate) issued by the Certificate Authority (CA) and click the [Execute] button to install the server certificate (security certificate).

If the server certificate (security certificate) is installed, its file name will be displayed.

For details, refer to "Installing a Server Certificate" (→ page 140).

CA Certificate - Information

This displays information relating to the server certificate (security certificate).

When the [Confirm] button is clicked, the registered content of the installed server certificate (security certificate) is displayed in the [Server Certificate - Confirm] dialog. If the server certificate (security certificate) is not installed, the content of the generated Certificate Signing Request (CSR) is displayed.

Click the [Delete] button to delete the installed server certificate (security certificate).

<NOTE>

- To delete an enabled server certificate (security certificate), confirm that there is a backup to the said certificate in your personal computer or recording media. A server certificate (security certificate) will be needed to reinstall it.

Connection

[HTTP, HTTPS]

This sets the method to connect to the unit.

HTTP	Only HTTP connection is possible.
HTTPS	Only HTTPS connection is possible.

Factory settings: HTTP

For details, refer to "Setting the Connection Method" (→ page 140).

<NOTE>

- When using an HTTPS connection, network connection with the AW-RP120, AW-RP50, and AK-HRP200 will be disabled.

HTTPS port [1 to 65535]

This sets the Port No. to be used with HTTPS.

The following port numbers are used by the unit so they cannot be used.

20, 21, 23, 25, 42, 53, 67, 68, 69, 80, 110, 123, 161, 162, 443, 546, 547, 554, 995, 5960 to 5985, 7960 to 8060, 10669, 10670, 11900, 59000 to 61000

Factory settings: 443

<NOTE>

- This unit will restart if the connection method is changed.
- When using a self-signed certificate:
 - A warning screen is displayed when accessing the camera by HTTPS for the first time. Install the self-signed certificate (security certificate) in your personal computer in accordance with the screen instructions. (→ page 141)
- When using a server certificate:
 - Install the Certificate Authority (CA) root certificate or intermediate certificate in your web browser in advance.
 - Follow the Certificate Authority (CA) procedures to acquire and install root certificates and intermediate certificates.
- When accessing the camera by HTTPS, the image display speed and frame rate of the moving image may reduce.
- When accessing the camera by HTTPS, it may take some time for the images to be displayed.
- When accessing the camera by HTTPS, images may be disturbed and sound may be interrupted.
- The maximum number of cameras that can be connected simultaneously depends on the maximum image size and distribution format.

HTTPS mode [TLS1.0/1.1/1.2/1.3, TLS1.2, TLS1.3]

This sets the encryption protocol when accessing the camera with HTTPS.

TLS1.0/1.1/1.2/1.3	Permits connection with TLS1.0/1.1/1.2/1.3 when HTTPS is enabled.
TLS1.2	Permits connection with TLS1.2 when HTTPS is enabled.
TLS1.3	Permits connection with TLS1.3 when HTTPS is enabled.

Factory settings: TLS1.2

Web screen configurations (continued)

● RTSP

This performs settings related to the RTSP function. The RTSP function sets the RTSP transmission port and RTSP request URL used during IP image transmission.

The setting is confirmed with the [Set] button.

RTSP	
RTSP port	554 (1-65535)
RTSP request URL H.264(1)	MediaInput/h264/stream_1
RTSP request URL H.264(2)	MediaInput/h264/stream_2
RTSP request URL H.264(3)	MediaInput/h264/stream_3
RTSP request URL H.264(4)	MediaInput/h264/stream_4
RTSP request URL H.265(1)	MediaInput/h265/stream_1
Set	

RTSP port [1 to 65535]

Sets the RTSP reception port no.

The following port numbers are used by the unit so they cannot be used.

20, 21, 23, 25, 42, 53, 67, 68, 69, 80, 110, 123, 161, 162, 443, 546, 547, 554, 995, 5960 to 5985, 7960 to 8060, 10669, 10670, 11900, 59000 to 61000

Factory settings: 554

RTSP request URL

Sets up the URL for RTSP when making IP image transmission demands to this unit.

RTSP request URL H.264(1)	RTSP URL for H.264(1) image transmission
RTSP request URL H.264(2)	RTSP URL for H.264(2) image transmission
RTSP request URL H.264(3)	RTSP URL for H.264(3) image transmission
RTSP request URL H.264(4)	RTSP URL for H.264(4) image transmission
RTSP request URL H.265(1)	RTSP URL for H.265(1) image transmission
RTSP request URL H.265(2)	RTSP URL for H.265(2) image transmission

Factory settings:

RTSP request URL H.264(1)	MediaInput/h264/stream_1
RTSP request URL H.264(2)	MediaInput/h264/stream_2
RTSP request URL H.264(3)	MediaInput/h264/stream_3
RTSP request URL H.264(4)	MediaInput/h264/stream_4
RTSP request URL H.265(1)	MediaInput/h265/stream_1
RTSP request URL H.265(2)	MediaInput/h265/stream_2

- Up to 255 characters can be entered.
- The following characters can be displayed.

Numeric characters	0123456789
Alphabetical characters (upper and lower cases)	ABCDEFGHIJKLMNOPQRSTUVWXYZ abcdefghijklmnopqrstuvwxyz
Symbols	/ - _

<NOTE>

- RTSP request URL cannot have the same URL.

● SNMP

Make SNMP functionality related settings. You can check the status of the unit by using the SNMP manager to connect.

The setting is confirmed with the [Set] button.

SNMP [On, Off]

Sets whether to use the SNMP function.

Factory settings: Off

User name

Sets the user name used for user authentication.

You need to specify the same user name that you set here in the SNMPv3 manager.

Maximum number of characters	0 to 32 characters
Characters that cannot be entered	Double-byte

Authentication

Sets the algorithm used for user authentication.

MD5	MD5 is used as the algorithm for user authentication.
SHA1	SHA1 is used as the algorithm for user authentication.

Factory settings: MD5

Encryption method

Sets the encryption method used for communications.

DES	DES is used as the encrypted communication method for SNMPv3.
AES	AES is used as the encrypted communication method for SNMPv3.

Factory settings: DES

Web screen configurations (continued)

Password

Sets the password used for user authentication.

You need to specify the same password that you specified here in the SNMPv3 manager.

Maximum number of characters	When [Authentication] is set to [MD5]: 8 to 16 characters When [Authentication] is set to [SHA1]: 8 to 20 characters
Characters that cannot be entered	Double-byte

System name

Enter the device name used to manage this unit using SNMP functionality.

Maximum number of characters	0 to 32 characters
Characters that cannot be entered	Double-byte

Location

Sets the location where this unit has been installed.

Maximum number of characters	0 to 32 characters
Characters that cannot be entered	Double-byte

Contact

Enter the email address or phone number of the administrator.

Maximum number of characters	0 to 255 characters
Characters that cannot be entered	Double-byte

● TSL5.0

Make settings related to TSL protocol version 5.0. Set the information required to control the tallies of this unit from a device that supports the TSL5.0 protocol with the TSL5.0 function.

The setting is confirmed with the [Set] button.

Index number [1 to 65534]

By matching the INDEX set on the TSL5.0 control device and the Index number of this unit, you can control the tallies of this unit individually.

Factory settings: 1

TSL5.0 Port [1 to 65535]

Sets the port number that will receive controls via the TSL 5.0 protocol.

Factory settings: 62000

● Referrer check

By enabling Referrer check, you can confirm that the device requesting access to the camera is legitimate.

Access is refused if it is determined that the device attempting access is unauthorized.

Depending on the environment in which the unit is being used, it may not be possible to access the unit when Referrer check is enabled.

If this occurs, you can access the unit by disabling Referrer check, but you will no longer be able to determine if the device attempting access is unauthorized.

Enable	The Referrer check function is used.
Disable	The Referrer check function is not used.

Factory settings: Enable

Web screen configurations (continued)

● mDNS

By setting an mDNS [Host name], it is possible to access this unit via <http://Host name.local>.

Maximum number of characters	63 characters
Characters that can be entered	Alphanumeric characters, symbols : -

Factory settings: panasonic-ptz

<NOTE>

- Proper operation cannot be guaranteed if there is another camera with the same settings in the same network.

● 802.1X

Makes settings for the IEEE 802.1X client.

<NOTE>

- You will require 802.1X knowledge in order to complete the settings. Consult the network administrator for details.
- It is necessary to make settings for an authentication server and Authenticator separately when building a system that uses this function. Consult the network administrator for details.
- In a system configuration where 802.1X is enabled, it is not possible to control the camera from AW-RP150 or AW-RP60.
- Before setting, go to either the [Date&Time] settings screen or the [NTP] settings screen to set the time for this unit. Proper operation may not be possible if the time has not be set correctly for the unit.
- Before setting, in the [Date&Time] settings screen, set [Memory] to [Enable].

802.1X [On, Off]

Sets whether to use the 802.1X function.

Factory settings: Off

EAP authentication method [TLS, PEAP]

Makes settings for the authentication method used for the 802.1X function.

This unit supports authentication methods using TLS or PEAP.

Factory settings: TLS

<NOTE>

- Proper operation may not be possible if it does not match the authentication method permitted by the authentication server.

TLS

Makes settings for when the TLS authentication method is used.

Client certificate type [PEM, PKCS#12]

Makes settings for the client certificate method used with TLS authentication.

This unit supports the PEM and PKCS#12 methods.

<NOTE>

- When a private key is to be used, the private key information must be included in the client certificate. Set [Private Key password usage] to [Enable] and set the correct password.
- When installing a client certificate with the PKCS#12 method, it is necessary to set [Private Key password usage] to [Enable] and to set the correct password.
- If the PKCS#12 method is selected, the PKCS#12 password and the [Private Key password] need to match.

Private Key password usage [Enable, Disable]

Sets whether to use a private key in the client certificate.

Enable	Select when a private key is to be used.
Disable	Select when a private key is not to be used.

<NOTE>

- If [Enable] is selected, the correct value needs to be set for [Private Key password].

Private Key password

Makes settings for the password set in the private key.

<NOTE>

- When installing a PKCS#12 method client certificate, enter the same password as the one set for PKCS#12.

TLS User name

Sets a user name permitted by TLS authentication.

<NOTE>

- Consult the network administrator regarding valid user names.

Client certificate install

Installs the client certificate.

<NOTE>

- The client certificate installed must be the correct one issued by the certificate authority.
- Before installing the certificate, check that the settings for [Client certificate type], [Private Key password usage], and [Private Key password] have been completed. The certificate may not be installed correctly if the above settings have not been completed.

Web screen configurations (continued)

PEAP

Makes settings for when the PEAP authentication method is used.

User name

Sets a user name permitted by PEAP authentication.

<NOTE>

- Consult the network administrator regarding valid user names.

Password

Sets the password attached to the User name in PEAP authentication.

<NOTE>

- Consult the network administrator regarding valid passwords.

CA Certificate install

Installs the CA certificate used in IEEE 802.1X authentication.

<NOTE>

- The CA certificate installed must be one issued by the correct certificate authority.

● Easy IP Setup Tool Plus

Makes settings related to Easy IP Setup Tool Plus.

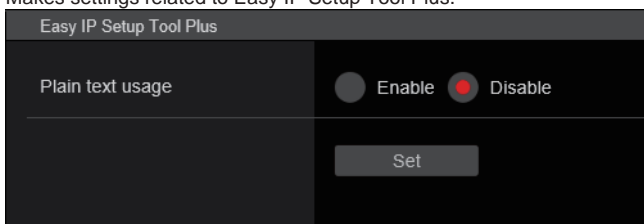

Plain text usage [Enable, Disable]

Sets whether to encrypt the communications with Easy IP Setup Tool Plus.

Factory settings: Disable

■ HTTPS settings [HTTPS]

This encrypts access to the camera and sets HTTPS to improve communication safety. Setting HTTPS is performed by following the procedures below. The setting is confirmed with the [Set] button.

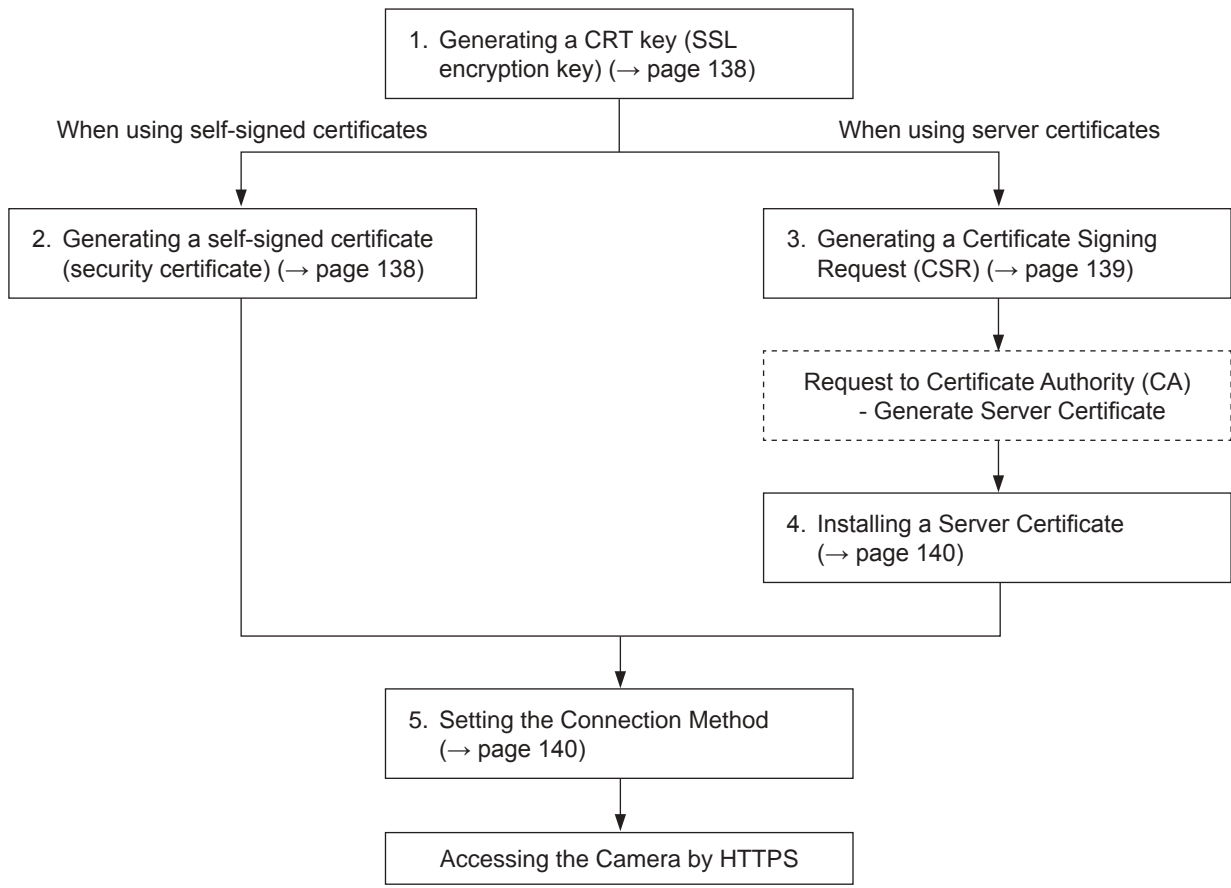
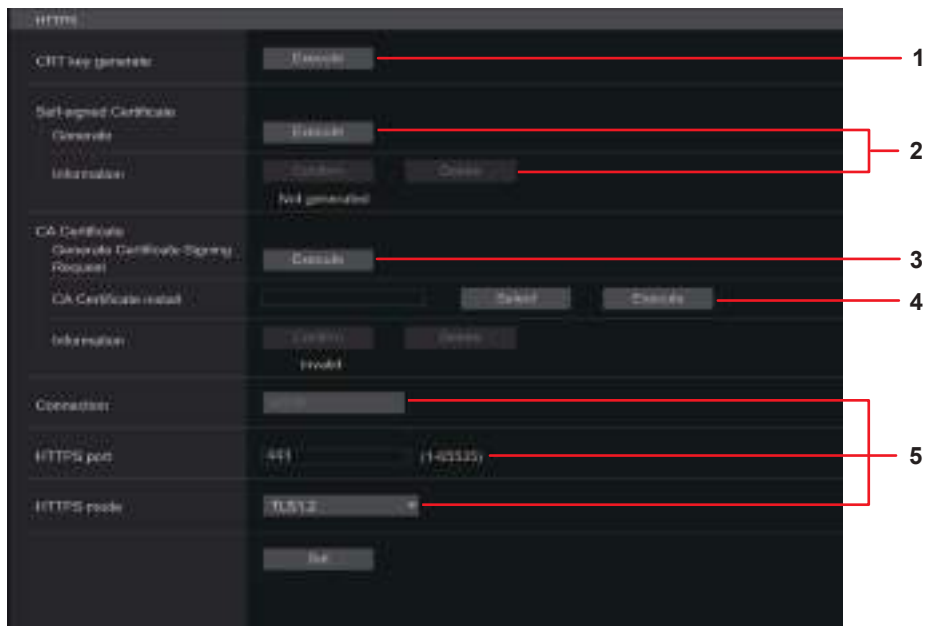

<NOTE>

- When using a server certificate, the process from applying to the Certificate Authority (CA) to issuing a server certificate must be performed between customers and the Certificate Authority (CA).
- Use either a self-signed certificate or server certificate. When simultaneously generating a self-signed certificate and installing a server certificate, this unit will prioritize the server certificate.

■ Generating a CRT key (SSL encryption key)
[CRT key generate]

<NOTE>

- A CRT key cannot be generated when self-signed certificates and server certificates are enabled.
- The size of the key that can be used by the Certificate Authority (CA) differs when using a server certificate. Confirm in advance the size of the key that can be used.
- Generating a CRT key takes about 1 minute for 1024 bit and about 2 minutes for 2048 bit. Do not operate the web browser until CRT key generation is complete. Image display and communication speed may reduce while generating a CRT key.

1. Click the [Execute] button in [CRT key generate].

The [Current CRT key] dialog is displayed.

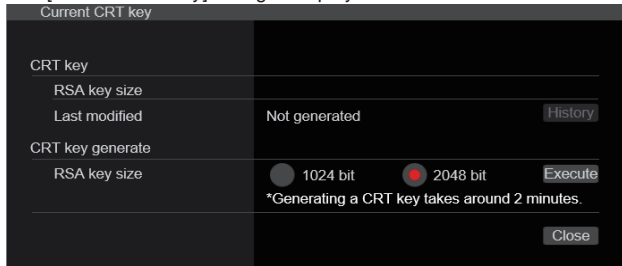

2. The size of the generated CRT key is selected from [1024bit]/[2048bit] in [CRT key generate] – [RSA key size].

<NOTE>

- When using a server certificate, the RSA key size must be in accordance with the demands of the Certificate Authority (CA) which will be applied to.

3. Click the [Execute] button.

CRT key generation starts.

The length of the generated CRT key and the date/time that generation completed are displayed in [Current CRT key] when CRT key generation finishes.

<NOTE>

- Perform procedures 1 to 3 to change (update) the generated CRT key. Because the CRT key, self-signed certificate and server certificate are enabled as a set, it will be necessary to once again generate a self-signed certificate or apply for a server certificate when the CRT key is changed.
- When the CRT key is changed, previous CRT keys are historically managed one at a time. Clicking the [History] button in the [CRT key] of the [Current CRT key] dialog displays the [Previous CRT key] dialog, allowing confirmation of the key size and the date and time generation was completed.

Clicking the [Apply] button in [Previous CRT key] allows the previous CRT key to be switched to the current CRT key.

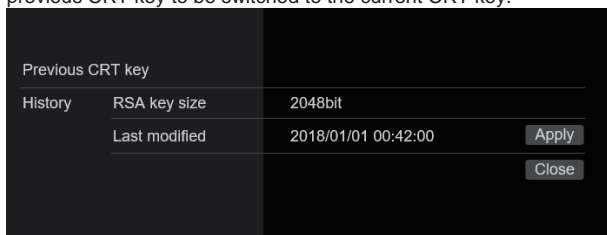

■ Generating a self-signed certificate (security certificate)
[Self-signed Certificate - Generate]

<NOTE>

- A self-signed certificate cannot be generated when a CRT key has not been generated.

1. Click the [Execute] button in [Self-signed Certificate] - [Generate].

[Self-signed Certificate - Generate] is displayed.

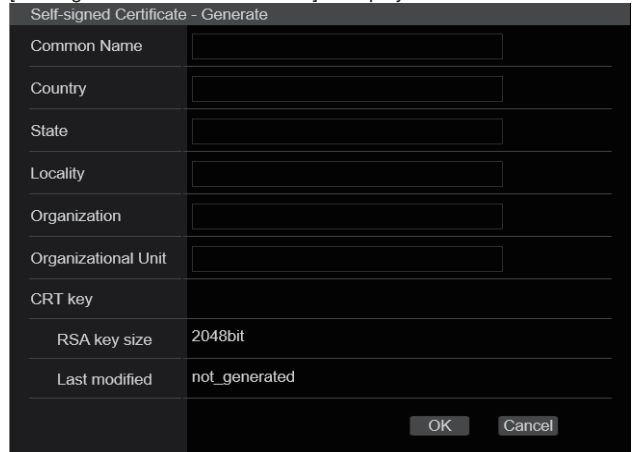

2. Input information relating to the certificate to be generated.

Items to be entered are as follows.

Item	Description	Maximum number of characters
Common Name	Inputs the camera address or host name.	64 characters
Country	Inputs the country code. (May be omitted)	2 characters: country code
State	Inputs the name of the state. (May be omitted)	128 characters
Locality	Inputs the name of the city. (May be omitted)	128 characters
Organization	Inputs the name of the organization. (May be omitted)	64 characters
Organizational Unit	Inputs the name of the organizational unit. (May be omitted)	64 characters
CRT key	Displays the size of the current CRT key and the date and time generation was completed.	

<NOTE>

- Characters that can be input for [Common Name], [Country], [State], [Locality], [Organization], [Organizational Unit] are 0 to 9, A to Z, a to z, and the following symbols: - , _ , + / ().
- When connecting the camera to the Internet, set the address or host name to be accessed from the Internet in [Common Name]. In this case, when accessing the camera locally, a security warning screen is displayed every time the camera is accessed even when a security certificate is installed.
- When inputting the IPv6 address in [Common Name], surround the address with [].
 e.g. [2001:db8::10]

3. Click the [OK] button after inputting the address.

A self-signed certificate is generated.

<NOTE>

- Information relating to the generated self-signed certificate is displayed in [Self-signed Certificate] - [Information]. The following is displayed depending on the status of the self-signed certificate (security certificate).

Displayed content	Description
Not generated	When the self-signed certificate is not generated
Invalid (Reason: CA Certificate installed)	When the self-signed certificate is already generated and the server certificate is already installed <ul style="list-style-type: none"> The server certificate is enabled in this case.
[Common Name] of self-signed certificate	When the self-signed certificate is already generated and enabled

- When the [Confirm] button is clicked, the registered content of the generated self-signed certificate (security certificate) is displayed in the [Self-signed Certificate - Confirm] dialog.



- Click the [Delete] button to delete the generated self-signed certificate (security certificate).
- When [HTTPS] is selected in [Connection], the self-signed certificate (security certificate) cannot be deleted.

■ Generating a Certificate Signing Request (CSR) [CA Certificate - Generate Certificate Signing Request]

<NOTE>

- A certificate signing request (CSR) cannot be generated if a CRT key has not been generated.
- To generate a certificate signing request (CSR), perform the following settings in advance in the web browser Internet options. Perform the following settings in the [Security] tab (accessed from [Tools] in the menu bar - [Internet Options] - [Security]).
- Register the camera as a "Trusted Site".
- In [Level Customize], go to [File Download] from [Download] and set to [Enable].
- In [Level Customize], go to [Automatically Display Dialog when Downloading File] from [Download] and set to [Enable].

1. Click the [Execute] button in [CA Certificate - Generate Certificate Signing Request].

The [CA Certificate - Generate Certificate Signing Request] dialog is displayed.

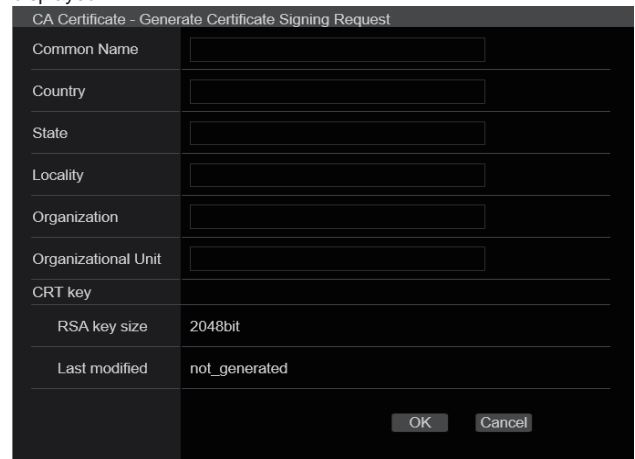

2. Input information relating to the certificate to be generated.

Items to be entered are as follows.

Item	Description	Maximum number of characters
Common Name	Inputs the camera address or host name.	64 characters
Country	Inputs the country code.	2 characters: country code
State	Inputs the name of the state.	128 characters
Locality	Inputs the name of the city.	128 characters
Organization	Inputs the name of the organization.	64 characters
Organizational Unit	Inputs the name of the organizational unit.	64 characters
CRT key	Displays the size of the current CRT key and the date and time generation was completed.	

<NOTE>

- When using a server certificate, the information to be input must be in accordance with the demands of the Certificate Authority (CA), which will be applied to.
- Characters that can be input for [Common Name], [Country], [State], [Locality], [Organization], [Organizational Unit] are 0 to 9, A to Z, a to z, and the following symbols: - , _ , + / ().

3. Click the [OK] button after inputting the address.

The [Save As] dialog is displayed.

4. In the [Save As] dialog, assign a file name to the Certificate Signing Request (CSR) and save it in personal computer.

Apply to the Certificate Authority (CA) using the saved Certificate Signing Request (CSR).

<NOTE>

- A server certificate is issued for both the generated Certificate Signing Request (CSR) and CRT key. The issued server certificate can no longer be used when generating/updating the CRT key after applying to the Certificate Authority (CA).
- The Certificate Signing Request (CSR) generated by this unit is in a PEM format.

■ Installing a Server Certificate

[CA Certificate - CA Certificate install]

<NOTE>

- A server certificate (security certificate) cannot be installed if a Certificate Signing Request (CSR) has not been generated.
- The server certificate must have been issued by the Certificate Authority (CA) in order to install it.

1. Click the [Select] button in [CA Certificate - CA Certificate install].

The [Open File] dialog is displayed.

2. Select the server certificate file and click [Open]. Then click the [Execute] button.

The server certificate is installed.

<NOTE>

- The name of the host registered to the installed server certificate is displayed in [CA Certificate] - [Information]. The following is also displayed depending on the status of the server certificate.

Displayed content	Description
Invalid	When the server certificate is not installed
[Common Name] of server certificate	When the server certificate is already installed and enabled
Expired	When the effective period of the server certificate has expired

- When the [Confirm] button is clicked, the content of the installed server certificate (security certificate) is displayed in the [CA Certificate - Confirm] dialog. (An asterisk is displayed in the [Organizational Unit] field only.)

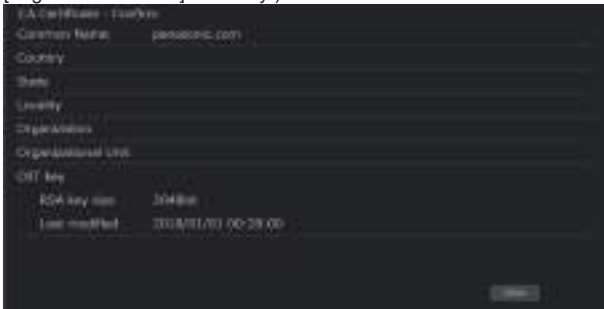

- Click the [Delete] button to delete the installed server certificate (security certificate).
- When [HTTPS] is selected in [Connection], the server certificate (security certificate) cannot be deleted.
- Perform STEP 1 to STEP 2 to update a server certificate.
- To delete an enabled server certificate (security certificate), confirm that there is a backup to the said certificate in your personal computer or recording media. A server certificate (security certificate) will be needed to reinstall it.
- The HTTPS function can no longer be used when the effective period of the server certificate has expired. In such a case, the connection method is changed to HTTP when the unit is restarted. Update the server certificate before its effective period expires.
- The effective period of the server certificate can be confirmed by double-clicking the server certificate file issued by the Certificate Authority (CA).

■ Setting the Connection Method

[Connection]

1. Set the method to access the camera in [Connection].

HTTP: Only HTTP connection is possible.

HTTPS: Only HTTPS connection is possible.

<NOTE>

- When using an HTTPS connection, network connection with the AW-RP120, AW-RP50, and AK-HRP200 will be disabled.

2. Set the Port No. to be used with HTTPS in [HTTPS port].

Port No. that can be selected: 1 to 65535

The following port numbers are used by the unit so they cannot be used.

20, 21, 23, 25, 42, 53, 67, 68, 69, 80, 110, 123, 161, 162, 443, 546, 547, 554, 995, 5960 to 5985, 7960 to 8060, 10669, 10670, 11900, 59000 to 61000

Factory settings: 443

3. Set the encryption protocol used with HTTPS in [HTTPS mode].

TLS1.0/1.1/1.2: Connection with TLS1.0/1.1/1.2 is possible.

TLS1.2: Connection with TLS1.2 is possible.

4. Click the [Set] button.

The camera restarts and access to the camera via HTTPS is enabled.

<NOTE>

- This unit will restart if the connection method is changed.
- **Using a self-signed certificate**
A warning screen is displayed when accessing the camera by HTTPS for the first time. Install the self-signed certificate (security certificate) in your personal computer in accordance with the screen instructions. (→ page 141)
- **Using a server certificate**
Install the Certificate Authority (CA) root certificate or intermediate certificate in your web browser in advance. Follow the Certificate Authority (CA) procedures to acquire and install root certificates and intermediate certificates.
- When accessing the camera by HTTPS, the image display speed and frame rate of the moving image may reduce.
- When accessing the camera by HTTPS, it may take some time for the images to be displayed.
- When accessing the camera by HTTPS, images may be disturbed and sound may be interrupted.
- The maximum number of cameras that can be connected simultaneously depends on the maximum image size and distribution format.

■ Accessing the Camera by HTTPS

1. Launch the web browser in your personal computer.

2. Input the camera's IP address in the address bar of the web browser.

Input address: https://192.168.0.10/

<NOTE>

- When the HTTPS port No. is changed from "443", input "https:// camera IP address: Port No." in the address bar.
E.g. https://192.168.0.11:61443
- When this unit is in a local network, set a proxy server from the web browser (menu bar: [Tools] - [Internet Options]) to ensure that a proxy server is not used for a local address.

3. Press the [Enter] key.

The live screen [Live] is displayed.

The security certificate is installed when the security warning screen is displayed. (→ page 141)

When [User auth.] is set to [On], the user name and password input screen is displayed before the live screen [Live] appears.

<NOTE>

- When HTTPS is used, screen and image display may slow down and image update interval (frame rate) may also slow down.

● Install the security certificate

When using HTTPS to access the camera, the security warning screen will be displayed if the security certificate of the said camera has not been installed in your personal computer. To prevent this warning screen being displayed, the security certificate must be installed in accordance with the following procedures. If it is not installed, the security warning screen will be displayed every time the camera is accessed.

<NOTE>

- The security certificate will be installed to your personal computer based on the content set for [Common Name]. The content set for the "Host Name" must therefore match that set for the address/host name used to access the camera. If the content differs, a security warning screen will be displayed every time the camera is accessed.
- A security warning screen will be displayed if the camera address/host name is changed even when a security certificate has been installed. Reinstall the security certificate.
- When connecting the camera to the Internet, set the address or host name to be accessed from the Internet in [Common Name]. In this case, when accessing the camera locally, a security warning screen is displayed every time the camera is accessed even when a security certificate is installed.
- When the security certificate is correctly installed, an icon of the key will be displayed in the address bar of the web browser accessing the camera.

1. Accessing the Camera by HTTPS.

2. When the security warning screen is displayed, click [Continue to this website (not recommended)].



The live screen [Live] is displayed.

When the authentication screen is displayed, input the user name and password.

<NOTE>

- When the above screen is displayed after accessing a device apart from the camera or a website, there may be a security problem, so check this carefully.

3. Click [Certificate error] in the URL and then click [View certificates].



4. Click [Install Certificate...].



<NOTE>

- If [Install Certificate...] is not displayed, close Internet Explorer and restart it by selecting [Run as Administrator]. Right-click on [Start] - [Program] - [Internet Explorer] and click [Execute as Administrator (A)..].

5. Click [Next], which is displayed in the certificate import wizard.



6. Select [Place all certificates in the following store] and click [Browse...].



7. Select [Trusted Root Certification Authorities] and click [OK].

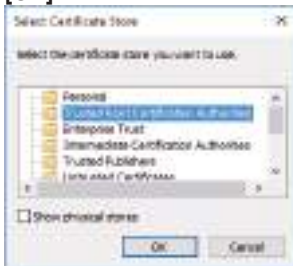

8. Click [Next].

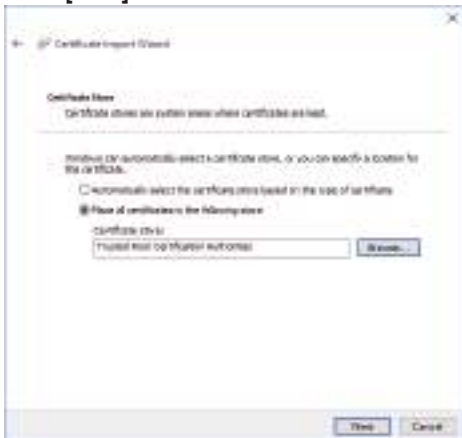

9. Click [Finish].



10. Click [Yes].

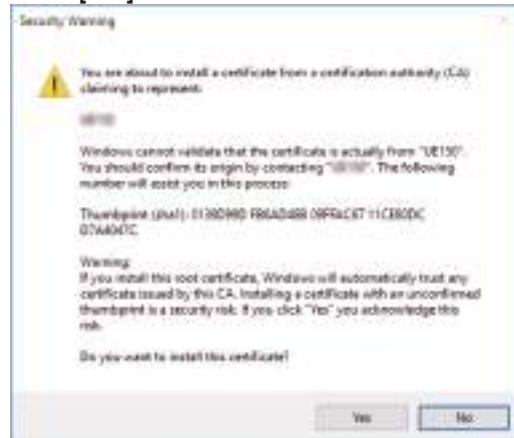

When importing is finished, the "The import was successful." screen is displayed.

11. Click [OK].

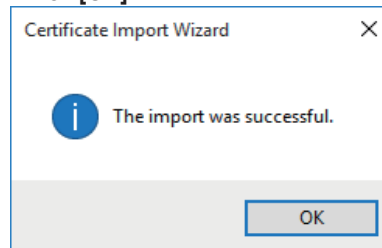

Closing the web browser after importing the certificate and reconnecting to it will stop the "Certificate error" screen being displayed.

Maintenance screen [Maintenance]

On this screen, you can check the system logs, check the version of the software, initialize the unit, etc.
The Maintenance screen consists of four settings: [System log], [Product info.], [Default reset] and [Backup].

■ System log screen [System log]

A maximum of 1000 event logs and a maximum of 100 error logs can be stored in the unit's internal memory.

When this maximum number has been exceeded, the old logs are overwritten successively by the new logs.

The logs are cleared when the unit's power is turned off.

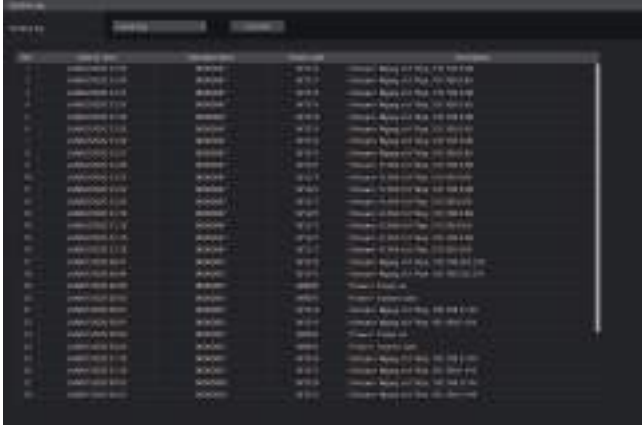

<NOTE>

- When the system log screen is displayed, the event log is displayed.

System log [Event log, Error log1, Error log2]

Switch the display between event logs and error logs.

The event log display is updated when you click the [Execute] button.

Event log	Displays the event logs.
Error log1	Displays the error logs.
Error log2	Displays the error logs.

[Event log]

No.

Displays the log sequence numbers.

"1" indicates the latest information, and up to 1000 logs can be saved.

Date & Time

Displays the dates and times when the events occurred.

The dates and times when the events occurred are indicated in 24-hour format according to the clock of the unit.

Operation time

Displays the dates and times when the events occurred.

The dates and times when the events occurred are indicated with the hour meter (0h to 99999h) of the unit.

Event code

Displays the event code numbers.

Description

Displays the event descriptions.

Display examples:

- <Power> Power on.
- <Stream> H.264 ch1 Play.
- <Stream> H.264 ch1 Stop.

[Error log1, Error log2]

No.

Displays the log sequence numbers.

"1" indicates the latest information, and up to 100 logs can be saved.

Date & Time

Displays the dates and times when the errors occurred.

The dates and times when the errors occurred are indicated in 24-hour format according to the clock of the unit.

Operation time

Displays the dates and times when the errors occurred.

The dates and times when the errors occurred are indicated with the hour meter (0h to 99999h) of the unit.

Error code

Displays the error code numbers.

Error description

Displays the error descriptions.

Display examples:

- Motor Driver Error
- Temp Sensor Error

■ Product information screen [Product info.]

The versions of the unit's software can be checked on this screen. The [Model no.], [MAC address], [Serial no.], [Firmware version] and other information about the unit is displayed.



Model no.

Display the unit's model number.

MAC address

Display the unit's MAC address.

Serial no.

Display the unit's serial number.

Firmware version

Display the overall system version of the unit.

CPU Software

Main/Network

Display the main/network software version.

Camera

Display the software version of the camera.

Lens

Display the software version of the lens.

Servo

Display the software version of the servo.

EEPROM

Main/Network

Display the EEPROM version of the main/network.

FPGA

Network

Displays the version of the Network module.

Enc

Displays the version of the image compression module.

Logic

Displays the version of the main functional part of FPGA.

Activation

Display information on the activated function.

Operation time

Display the hours the unit has been operating.

Viewer software installation counter

The number of plug-in viewer software applications which have been installed automatically from the unit is displayed by this counter.

OSS license display

When you press the [View] button, the OSS license appears. Press the [Close] button to close the OSS license display screen.

Firmware file

Upgrade the firmware.

For details on how to upgrade, see "Upgrading the firmware (Firmware file)" (→ page 145).

● Upgrading the firmware (Firmware file)

1. Download the latest software to your personal computer.

<NOTE>

- Keep the maximum combined number of characters to be used for the name of the directory in which the software will be stored and for the name of the software which has been downloaded to less than 250 characters.

2. Click the [Select] button, and specify the downloaded software.

3. Click the [Execute] button.

The software upgrade check screen is displayed.

After upgrading the software version, be absolutely sure to delete the temporary Internet files.

<NOTE>

- An upgrade progress bar appears after you click the [Execute] button, and the process will take about 1 minute.
- Use the personal computer on the same subnet as the camera to upgrade the software version.
- Before using the version upgrading software, be absolutely sure to check the precautions to be observed, and follow the instructions.
- Use the following files specified by Panasonic Corporation as the software used for version upgrading.

UPDATE.HDC

- Do not turn off the unit's power while a software version is being upgraded. (A pop-up screen will appear to indicate that the process is complete.)
- While a software version is being upgraded, do not attempt to execute any other operations until the version has been upgraded.
- Close the web browser once after performing a version upgrade.

■ Reset settings screen [Default reset]

The unit's setting data is initialized and the unit is restarted on this screen.

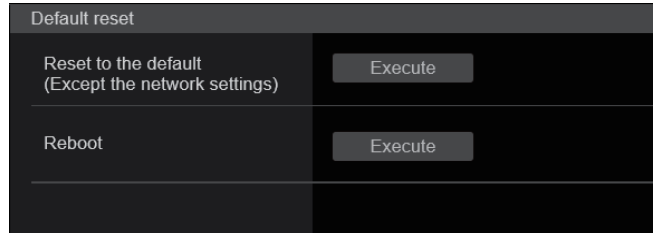

Reset to the default (Except the network settings)

When the [Execute] button is clicked, the unit's settings are returned to their defaults.

When the initialization operation is started, the unit is restarted so no operations can be undertaken for about 2 minutes.

<NOTE>

- The following setting items will not be returned to defaults.
 - [Live page - Automatic installation of viewer software]
 - [Live page - Smoother live video display on the browser(buffering)]
 - All settings under [User mng.]
 - All settings under [Network - Network]
 - [HTTPS - Connection]
 - [HTTPS - HTTPS port]
 - [HTTPS - HTTPS mode]
 - HTTPS: CRT key, server certificate
 - All settings under [UPnP]
- [AWB] and [ABB] adjustment values will not be returned to defaults.
- The settings for [Format] and [Frequency] (→ page 93) are not initialized.

Reboot

When the [Execute] button is clicked, the unit is rebooted.

After the unit has been rebooted, no operations can be undertaken for about 2 minutes as is the case when the unit's power is turned on.

■ Back up screen [Backup]

On this screen, the unit's settings can be saved to a personal computer or settings saved in a personal computer can be loaded into the unit for use.

Download

Config data type

[Camera(ALL), Camera (SCENE1) to Camera (SCENE3), Camera (SCENE Full Auto), Camera (SCENE ALL), Camera (SYSTEM), Camera (PRESET), Network]

Specify the type of settings to save when saving the unit's configuration data on the personal computer.

Setting value	Content to be saved	Extension of saving file
Camera(ALL)	Settings for Scene1, 2, 3, Full Auto Settings for System, Output, Pan/Tilt, Preset (These are saved as one setting file.)	.cal
Camera (SCENE1)	Settings for Scene1	.cs1
Camera (SCENE2)	Settings for Scene2	.cs2
Camera (SCENE3)	Settings for Scene3	.cs3
Camera (SCENE Full Auto)	Settings for SCENE Full Auto	.csfa
Camera (SCENE ALL)	Settings for Scene1, 2, 3 (Setting files are saved for each Scene.)	.cs1 .cs2 .cs3
Camera (SYSTEM)	Settings for System, Output, Pan/Tilt, Preset	.csy
Camera (PRESET)	Preset	.cpr
Network	Settings of the Web screen Network settings	.nal

Download

Save the unit's settings onto the personal computer.

When the destination dialog box appears after clicking the [Download] button, specify the destination folder.

<NOTE>

- After the [Download] button is clicked, the amount of time it takes for the destination dialog box to appear is about 50 seconds for a camera settings file and about 10 seconds for a network settings file.
- Depending on the status of the unit, it may not be possible to download configuration files. In this case, the unit automatically restarts.

Upload

Config data type

[Camera(ALL), Camera (SCENE1) to Camera (SCENE3), Camera (SCENE Full Auto), Camera (SYSTEM), Camera (PRESET), Network]

Specify the type of configuration data when reflecting the configuration data saved on a personal computer to this unit.

Setting value	File extension suitable for upload
Camera(ALL)	.cal
Camera (SCENE1)	.cs1
Camera (SCENE2)	.cs2
Camera (SCENE3)	.cs3
Camera (SCENE Full Auto)	.csfa
Camera (SYSTEM)	.csy
Camera (PRESET)	.cpr
Network	.nal

Upload

The unit's setting files, which were saved in the personal computer by the download function, are uploaded.

Click the [Select] button to display the dialog box, and specify the saved file.

When you click the [OK] button in the message dialog box that appears after you click the [Upload] button, uploading starts.

Another message dialog box appears after uploading is complete. When you click the [OK] button, the unit will restart automatically.

<NOTE>

- Use the files downloaded by the unit as the data to be used for uploading.
- Do not turn off the unit's power while downloading or uploading is underway.
- Do not attempt to perform any operations while downloading or uploading is underway. Instead, wait until the downloading or uploading is completed.
- It takes about 3 minutes for the upload complete dialog box to appear for camera settings files.
- When uploading Camera(ALL), Camera(SYSTEM) or Camera(PRESET), the still image (thumbnail) that has been registered in preset memory will be erased. (→ page 66)



PTZ operation screen for touch panels



1. Button for displaying the PTZ operation screen for touch panels

The screen switches to the one for PTZ operations for touch panels when this button is pressed.

2. Button for displaying the Preset operation screen for touch panels

The screen switches to the one for Preset operations for touch panels when this button is pressed.

3. Button for displaying the Image Adjust operation screen for touch panels

The screen switches to the one for Image Adjust operations for touch panels when this button is pressed.

4. Button for restoring the screen from the touch panel operation screen

Press this button to return to the usual live screen.

5. Buttons for switching the touch panel operation screen

Use these to switch the [PTZ]/[Preset]/[Image adjust] operation screens for touch panels.

6. PTZ operation area for touch panels

This is the area where buttons for operating zoom, focus, pan/tilt, and speed are located that are suitable for use with touch panels. The functionality of the operation buttons is the same as the buttons displayed in the usual live screen.

7. SRT/MPEG2-TS/RTMP operation area for touch panels

This is the area where SRT/MPEG2-TS/RTMP operation buttons are located that are suitable for use with touch panels. The functionality of the operation buttons is the same as the buttons displayed in the usual live screen.

8. Snapshot button for touch panels

This snapshot button is suitable for use with touch panels. The functionality of the operation buttons is the same as the buttons displayed in the usual live screen.

■ Preset operation screen for touch panels

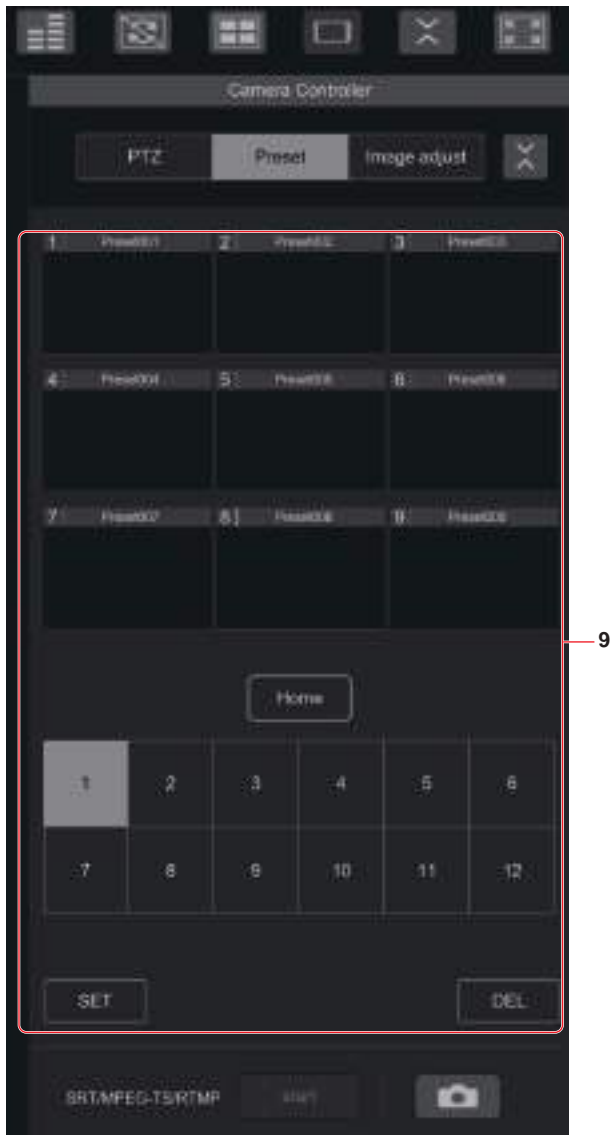

9. Preset operation area for touch panels

This is the area where buttons for preset operations are located that are suitable for use with touch panels.

The functionality of the operation buttons is the same as the buttons displayed in the usual live screen.

■ Image adjust operation screen for touch panels



10. Image adjust operation area for touch panels

This is the area where buttons for iris, gain, balance adjustments, shutter, ND filter, and scene operations are located that are suitable for use with touch panels.

The functionality of the operation buttons is the same as the buttons displayed in the usual live screen.

■ Setup operation area for touch panels

Even when the Setup screen is displayed, it is possible to display a Setup menu that is suitable for use with touch panels.

The functionality of the operation buttons is the same as the buttons displayed in the usual live screen.

Displaying the web screen using a mobile terminal

It is possible to perform operations using a design suited to mobile terminals in the live screen in a web browser.

1. Access the unit from the mobile terminal.

As when accessing the unit from a personal computer, enter [http://IP address/] in the address bar of the web browser on the mobile terminal. The screen for mobile terminals is displayed automatically.

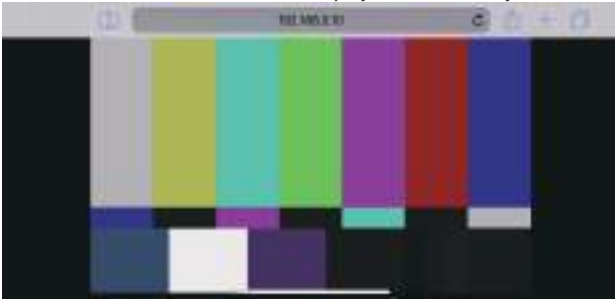

2. Switch the display.

The Full Screen mode is engaged and only video is displayed immediately after accessing the unit via a web browser on the mobile terminal. Three types of screen are available on the mobile terminal: "Camera Control", "Full Screen", and "Touch Operation Select".

Camera Control

Full Screen

Touch Operation Select

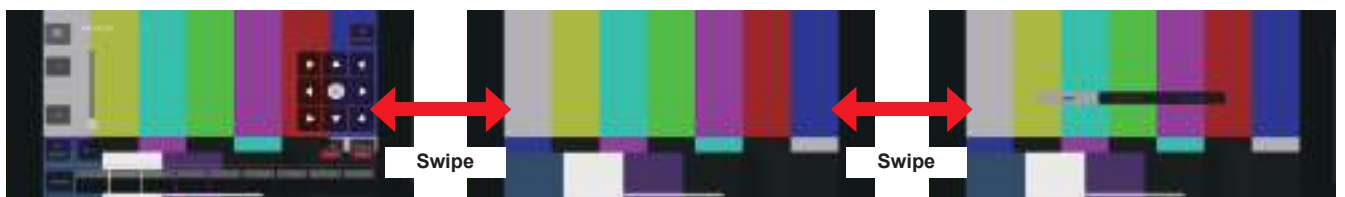

You can switch between Camera Control, Full Screen, and Touch Operation Select by swiping left or right. When Touch P/T is selected in Touch Operation Select, the middle-click function is enabled in Full Screen mode. Furthermore, when Touch AF is selected, the Touch AF function is enabled in Full Screen mode.

<NOTE>

- When the button is selected in Touch Operation Select, the screen automatically switches to Full Screen.
- Only images in the M-JPEG format are available for display on mobile terminals.

Camera control screen [Camera Control]

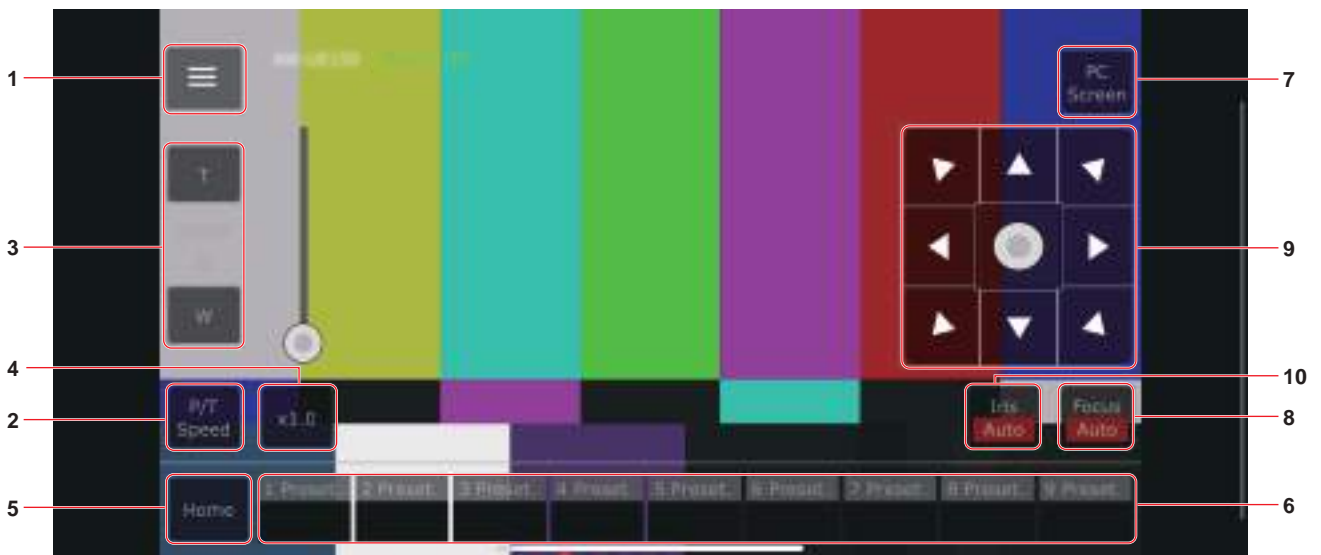

1. Button for displaying the operation menu for the live screen

Use this to display the operation menu for the live screen.



< Live

Use this to close the operation menu for the live screen.

Power

Switch Power On/Standby.

For details, refer to the [Power On] button and [Standby] button.

Compression

As only JPEG images can be displayed on mobile terminals, only the [JPEG] button is displayed.

Streaming

Switch between JPEG(1)/JPEG(2)/JPEG(3).

For details, refer to [Stream].

Zoom

Enable or disable [D-Zoom], [D-Ext. x1.4], and [D-Ext. x2.0].

For details, refer to [Zoom].

Stream (SRT/RTMP)

Starts streaming transmission to the RTMP/RTMPS server or the SRT compatible decoder that was pre-registered.

Lock(WEB)

Enable or disable [Lock(WEB)].

For details, refer to Operation lock button [Lock].

Color Bar

Switch the color bar signal displayed or hide.

Bar Type

Switch the color bar displayed between Type1 and Type2.

2. Button for switching P/T Speed/Zoom

Use this to switch the buttons in the operation area.

When this is pressed while [P/T Speed] is being displayed, this displays the speed [Speed] button/slider in the operation area.

When this is pressed while [Zoom] is being displayed, this displays the zoom [Zoom] button/slider in the operation area.

3. P/T Speed/Zoom operation area

The [P/T Speed]/[Zoom] button/slider is displayed.

Switch between [P/T Speed] and [Zoom] with the button for switching P/T Speed/Zoom.

- The functionality of the operation buttons is the same as the buttons displayed in the usual live screen.

4. x1.0 button

Use this to adjust the zoom (magnification) to 1.0x.

5. Home button

Move to the preset home position.

6. Preset thumbnail operation area

When a preset thumbnail is clicked, the camera moves to face towards a preset position that was registered beforehand.

By swiping left in the preset thumbnail operation area, preset thumbnails that are not displayed can be displayed.

- You can select Preset1 to Preset100.

7. Button for switching the personal computer screen

This is used for switching to the live screen display for a personal computer.

Press the mobile screen display button on the live screen for personal computers to return to the mobile live screen.

Mobile screen display button:



8. Button for switching PTZ/Focus

Use this to switch the buttons in the operation area.

When this is pressed while [PTZ] is being displayed, this displays the control pad buttons in the operation area.

When this is pressed while [Focus Manual] or [Focus Auto] is being displayed, this displays the [Focus] button/slider in the operation area.

9. PTZ/Focus operation area

The [PTZ]/[Focus] button/slider is displayed.

Switch between [PTZ] and [Focus] with the button for switching PTZ/Focus.

- The functionality of the operation buttons is the same as the buttons displayed in the usual live screen.

10. Focus (AUTO)/Iris (AUTO) button

When [PTZ] is selected with the button for switching [PTZ]/[Focus], the button for enabling or disabling Iris (Auto) is displayed.

When [Focus] is selected, the button for enabling or disabling Focus (Auto) is displayed.

■ Control Area

In the Control Area, operations by operation buttons are prioritized.

Scrolling of the screen as a whole can be done with touch operations outside the Control Area.



<NOTE>

- Depending on the mobile terminal you are using, it may be necessary to scroll the screen as a whole to adjust the position of the Control Area.

Limiters

This unit comes with settings (referred to as “limiters”) that restrict the panning and tilting movement ranges.

Depending on the installation location, obstacles that may come into contact with the remote camera may exist within its movement range. In such cases, setting the limiters before the obstacles will prevent contact.

The positions of four limiters — namely, the upper, lower, leftmost and right-most limits of the travel range — can be set. Once they have been set, the positions will not be lost even after the power has been turned off.

The limiters can be set or released both by the wireless remote control and controller or web setting screen [Setup]. Whatever was set or released last takes precedence. For the controller operations, refer to the Operating Instructions of the controller.

The settings of the limiters using the wireless remote control will be described here.

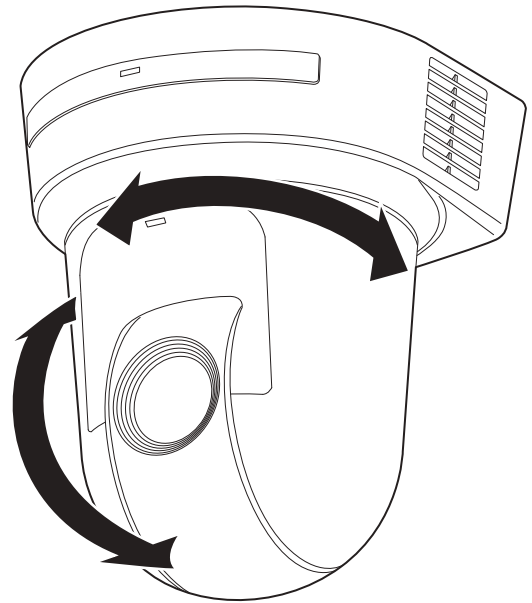

Setting/releasing the limiters

Basic limiter operations

1. Press the <MENU> button.

Tap the button (rather than pressing it). When it is pressed for 2 seconds, the camera menu will appear. If this happens, press the <MENU> button again for 2 seconds to clear the camera menu.

Then start again from step 1.

2. Press the <▲/▼/◀/▶> button for 2 seconds while holding down the <PRESET> button.

The limiter for the upper limit, lower limit, left limit or right limit is set (or released) using these direction buttons, respectively. The tally lamp will blink at this time. When a limiter is set, it blinks once; when a limiter is released, it blinks twice.

If any other button was operated between steps 1 and 2, start again from step 1.

Setting the limiters

The limiter positions can be set by following the steps below. When the position is set, the tally lamp blinks once.

1. Press one of the CAMERA <1> to <4> button to select the unit.

• Setting the upper limit position of the movement range

Press the <▲> or <▼> button of the wireless remote control to turn the unit as far as the position which will serve as the upper limit.

Next, perform the steps in "Basic limiter operations". (Press the <MENU> button quickly and then press the <▲> button for 2 seconds while holding down the <PRESET> button.)

• Setting the lower limit position of the movement range

Press the <▲> or <▼> button of the wireless remote control to turn the unit as far as the position which will serve as the lower limit.

Next, perform the steps in "Basic limiter operations". (Press the <MENU> button quickly and then press the <▼> button for 2 seconds while holding down the <PRESET> button.)

• Setting the left-most limit position of the movement range

Press the <◀> or <▶> button of the wireless remote control to turn the unit as far as the position which will serve as the left-most limit.

Next, perform the steps in "Basic limiter operations". (Press the <MENU> button quickly and then press the <◀> button for 2 seconds while holding down the <PRESET> button.)

• Setting the right-most limit position of the movement range

Press the <◀> or <▶> button of the wireless remote control to turn the unit as far as the position which will serve as the right-most limit.

Next, perform the steps in "Basic limiter operations". (Press the <MENU> button quickly and then press the <▶> button for 2 seconds while holding down the <PRESET> button.)

Releasing the limiters

The limiter positions that are set can be released by following the steps below.

When the position is released, the tally lamp blinks twice.

1. Press one of the CAMERA <1> to <4> button to select the unit.

2. Release the limiters by taking the steps below.

• Releasing the upper limit position of the movement range

Perform the steps in "Basic limiter operations". (Press the <MENU> button quickly and then press the <▲> button for 2 seconds while holding down the <PRESET> button.)

• Releasing the lower limit position of the movement range

Perform the steps in "Basic limiter operations". (Press the <MENU> button quickly and then press the <▼> button for 2 seconds while holding down the <PRESET> button.)

• Releasing the left-most limit position of the movement range

Perform the steps in "Basic limiter operations". (Press the <MENU> button quickly and then press the <◀> button for 2 seconds while holding down the <PRESET> button.)

• Releasing the right-most limit position of the movement range

Perform the steps in "Basic limiter operations". (Press the <MENU> button quickly and then press the <▶> button for 2 seconds while holding down the <PRESET> button.)

Resetting the limiters

To reset the limiters, the currently established settings must be released. The limiter positions that are set can be reset by following the steps below.

1. Release the settings of the limiter positions to be reset by following the steps in "Releasing the limiters".

2. Set the limiter positions by following the steps in "Setting the limiters".

Safe mode

Concerning the safe mode

The unit goes into the safe mode when the pan-tilt head is forcibly moved by an external force or when something impedes its rotation. Once the safe mode has been established, some or all of the operations will no longer be acknowledged to ensure safety and prevent equipment damage.

Detection of equipment trouble

When the unit has detected trouble, its functions are shut down, then the unit is restarted or the initial setting operation is performed, and the normal condition of the unit is restored after about 30 seconds.

<NOTE>

- When trouble is detected, pictures may no longer be output for a while, but they will be restored in 5 seconds to 10 seconds.

Troubleshooting

■ Operation

Symptom	Cause and solution	Reference pages
No power	<ul style="list-style-type: none"> • Is the AC adaptor securely connected to the AC outlet? 	---
	<ul style="list-style-type: none"> • If the power plug of the AC adaptor connected properly? 	---
	<ul style="list-style-type: none"> • Is the LAN cable connected securely to the LAN connector for IP control <LAN LINK/ACT>? 	page 17
	<ul style="list-style-type: none"> • Is the network cable for the PoE++ (IEEE 802.3bt compliant) compatible power supply device and the unit connected properly? 	Installation Instructions → "Connections" → "System example 3 (IP image transmission, PoE++)"
	<ul style="list-style-type: none"> • Power may not be supplied if the total power limit is exceeded on power supply devices that allow connections to multiple PoE++ terminals. → For details, refer to the operating instructions for the PoE++ power supply device. 	---
	<ul style="list-style-type: none"> • If the unit is connected to the controller, has it been connected properly? → For details, refer to the operating instructions for the controller. 	Installation Instructions → "Connections"
	<ul style="list-style-type: none"> • When performing operations from a wireless remote control → Also refer to the "Cannot operate using the wireless remote control" item. 	---
Cannot operate (common to wireless remote control, controller)	<ul style="list-style-type: none"> • Is the power on? → If the unit's status display lamp is off or lights up orange, it means that the unit's power is not on. 	page 31
	<ul style="list-style-type: none"> • The safe mode function may have been activated. 	page 153
	<ul style="list-style-type: none"> • Have the limiter functions been set? 	pages 151 to 152
	<ul style="list-style-type: none"> • Has the unit you want to operate been selected properly? 	page 32
Cannot operate using the wireless remote control	<ul style="list-style-type: none"> • Have the remote control's batteries run down or have the batteries been installed with their polarities reversed? → If the status display lamp does not blink even when the wireless remote control is operated near the wireless remote control signal light-sensing area, it means that the batteries have run down. Replace the batteries. 	---
	<ul style="list-style-type: none"> • Have the IR ID switches been set correctly? 	page 18, page 26
	<ul style="list-style-type: none"> • Is there a fluorescent light or plasma monitor near the unit and, if so, is the wireless remote control signal light-sensing area exposed to its light? 	page 15
Cannot operate using the controller	<ul style="list-style-type: none"> • Is the unit connected to the controller properly? → For details, refer to the operating instructions for the controller. 	Installation Instructions → "Connections"
	<ul style="list-style-type: none"> • Has the initial account been set up? → If the initial account has not been set up yet, this unit can be recognized by either AW-RP150 or AW-RP60, but they are not able to control it. 	page 28
	<ul style="list-style-type: none"> • It may be necessary to upgrade the version of the controller so that the controller will support the unit. → For details on upgrading, visit the support page on the following website. https://pro-av.panasonic.net/ 	---
The unit turns in the opposite direction to the one operated	<ul style="list-style-type: none"> • Has the stand-alone (Desktop) installation setting been selected correctly? 	page 63, page 97
	<ul style="list-style-type: none"> • The reversal setting may have been established at the controller if the unit is connected to the controller. → For details, refer to the operating instructions for the controller. 	---

Troubleshooting (continued)

Symptom	Cause and solution	Reference pages
Cannot access from a web browser	<ul style="list-style-type: none"> • Has a LAN cable of category 5e or above been connected to the LAN connector for IP control <LAN LINK/ACT>? 	Installation Instructions → "Connections"
	<ul style="list-style-type: none"> • Is the [LINK] LED of the LAN connector for IP control lit? → If it is not lit, it means that something is wrong with the connection to the LAN or that the network at the connection destination is not working properly. Check the LAN cable for defective contacts, and check the wiring. 	page 17
	<ul style="list-style-type: none"> • Is the power on? → If the unit's status display lamp is off or lights up orange, it means that the unit's power is not on. 	page 31
	<ul style="list-style-type: none"> • Has a valid IP address been set in the unit? 	page 126
	<ul style="list-style-type: none"> • Has the wrong IP address been accessed? → Check the connections by following the steps below. For Windows: Using the Windows command prompt, execute > ping [IP address which has been set in the camera] A reply returned from the unit signifies that there are no problems in operation. If a reply is not received, try following operation: • Reboot the unit, and within 20 minutes change the IP address using the Easy IP Setup Software. For Mac: Using the macOS terminal, execute > ping -c 10 [IP address which has been set in the camera] A reply returned from the unit signifies that there are no problems in operation. 	---
	<ul style="list-style-type: none"> • Are you accessing via "http://" while the HTTPS function is enabled? → Perform access via "https://" when using the HTTPS function. Entry of the port number is also required. 	page 140
	<ul style="list-style-type: none"> • Is the same IP address setting being used by another unit? → Check out the IP addresses of the unit, access devices (personal computer, controller, etc.) and any other cameras. 	page 71
	<ul style="list-style-type: none"> • Does the subnet mask setting match the network subnet of the connection destination? → Check out the subnet mask settings of the unit and access devices, and then consult with the network administrator. 	page 71
	<ul style="list-style-type: none"> • Has the "Use a proxy server" setting been selected by the web browser? (When the unit and the personal computer are connected to the same subnet) → If a proxy server has been set using the [proxy setting] of the web browser, it is recommended that a "Don't use proxy" address be selected as the unit's IP address setting. 	---
<ul style="list-style-type: none"> • Has the wrong default gateway been set for the unit? (When the unit and personal computer are connected to different subnets) → Check out the default gateway that has been set for the unit, and then consult with the network administrator. 	page 71	

Troubleshooting (continued)

Symptom	Cause and solution	Reference pages
The settings on the web setting screen [Setup] are not updated or displayed properly	For Windows: <ul style="list-style-type: none"> • Press the [F5] key on the keyboard of the personal computer to request that the settings be acquired. For Mac: <ul style="list-style-type: none"> • Press the [Command] + [R] key on the personal computer's keyboard to request that the settings be acquired. 	---
	<ul style="list-style-type: none"> • Perform the following to delete the temporary Internet files. For Windows: <ol style="list-style-type: none"> ① Select [Tools] - [Internet Options] in Internet Explorer. ② Click the [General] tab, and click the [Delete] button under [Browsing history]. ③ In the [Delete Browsing History] dialog box, select the [Temporary Internet files and website files] checkbox, and then click [Delete]. ④ Click the [OK] button. For Mac: <ol style="list-style-type: none"> ① Select [Develop] - [Empty Cache] in Safari. ② Click [Empty] in the [Are you sure you want to empty the cache?] pop-up screen. 	---
	For Windows: <ul style="list-style-type: none"> • If [Check for newer versions of stored pages] is not set to [Every time I visit the webpage] in the temporary Internet file settings, the web setup screen may not appear. <ul style="list-style-type: none"> → Perform the following. <ol style="list-style-type: none"> ① Select [Tools] - [Internet Options] in Internet Explorer. ② Click the [General] tab, and click the [Settings] button under [Browsing history]. ③ In the [Temporary Internet Files] dialog box, select the [Every time I visit the webpage] option under [Check for newer versions of stored pages]. ④ Click the [OK] button. 	---
	<ul style="list-style-type: none"> • The unit's ports may be filtered by the firewall or other function of the anti-virus software. <ul style="list-style-type: none"> → Change the HTTP port number of the unit to a port number that will not be filtered. 	---
It is not possible to download the setting files	For Windows: <ul style="list-style-type: none"> • Has the file download function been disabled? <ul style="list-style-type: none"> → Perform the following. <ol style="list-style-type: none"> ① Select [Tools] - [Internet Options] in Internet Explorer. ② Click the [Security] tab, and click the [Custom level] button under [Security level for this zone]. ③ In the [Security Settings] dialog box, select the [Enable] option for [File download]. ④ Click the [OK] button. ⑤ Click the [OK] button. 	---
The tally lamps do not light	<ul style="list-style-type: none"> • Is the [Tally] setting set to [Disable]? <ul style="list-style-type: none"> → If [Tally] is set to [Disable], the unit's tally lamp does not light. Change the setting to [Enable]. 	page 62, page 97
Status display lamp does not light	<ul style="list-style-type: none"> • Is the [Status Lamp] setting set to [Disable]? <ul style="list-style-type: none"> → If [Status Lamp] is set to [Disable], the status display lamp does not light when this unit is working properly. Change the setting to [Enable]. 	page 63, page 97
The authentication screen appears repeatedly	<ul style="list-style-type: none"> • Has the user name or password been changed? <ul style="list-style-type: none"> → If you change the user name and password of the user currently logged in from a separate web browser while the unit is being accessed, the authentication screen appears each time the screen display is changed. Close the web browser, and initiate access to the unit again. 	page 124
	<ul style="list-style-type: none"> • Has the method for user authentication been changed? <ul style="list-style-type: none"> → If you change the [User auth.] - [Authentication] setting, close the web browser and initiate access again. 	page 124

Troubleshooting (continued)

Symptom	Cause and solution	Reference pages
Screens displays take a while to appear	<ul style="list-style-type: none"> • Is access being performed in HTTPS mode? Screen displays may take a while to appear in HTTPS mode due to signal processing. 	---
	<ul style="list-style-type: none"> • Is the unit on the same local network and being accessed via proxy? → Configure the web browser settings so that access is not performed via proxy. 	---
	<ul style="list-style-type: none"> • Are multiple users accessing the unit's IP images at the same time? → When multiple users access the unit's IP images at the same time, images may take some time to appear, and the frame rate of the IP images may drop. 	---

Video

Symptom	Cause and solution	Reference pages
No pictures are displayed or the pictures are disturbed	<ul style="list-style-type: none"> • Has the unit been connected properly to the other connected devices? 	Installation Instructions → "Connections"
	<ul style="list-style-type: none"> • If the system is configured in such a way that the picture is also switched when the unit to be operated is selected, has the correct unit been selected? 	page 32
	<ul style="list-style-type: none"> • Has the image signal setting been selected correctly? 	page 56, page 93
	<ul style="list-style-type: none"> • Are external sync signals that are supported by the video signal format which has been set being input? 	page 17
The picture is flipped vertically	<ul style="list-style-type: none"> • Has the stand-alone (Desktop) installation setting been selected correctly? 	page 63, page 97
Multiple color bands (color bars) are displayed	<ul style="list-style-type: none"> • Switch to the camera picture. 	page 36
The menu screen is displayed	<ul style="list-style-type: none"> • Exit the camera menu. 	page 45
It is difficult to view the menu screens	<ul style="list-style-type: none"> • Depending on the HDMI monitor you are using, you may experience one or more of the symptoms described below. <ul style="list-style-type: none"> • The resolution of the characters in the camera menu displays changes as the background image changes. • Depending on the edge enhancement setting established for the monitor, white lines appear in front of the black shadows of the camera menus. • Depending on the edge enhancement setting established for the monitor, the background colors may be superimposed onto the white parts of the camera menus. 	---
No auto focusing	<ul style="list-style-type: none"> • Is the focus set to manual? → Auto focusing is initiated as soon as the focus is set to auto. 	page 36
	<ul style="list-style-type: none"> • In some situations, it may be hard to focus at the auto setting. → In cases like this, select the manual setting, and focus manually. 	page 38
The subject is not brought into focus during zooming when the manual setting is used for the focus	<ul style="list-style-type: none"> • Was the focus adjusted at the Tele end? → First adjust the focus at the Tele end where the focusing accuracy is higher, and then proceed with the zooming. 	---
	<ul style="list-style-type: none"> • Under some operating conditions, it may be hard to bring subjects into focus. → In such cases, use the focus at the auto setting. 	page 36
The video appears jerky	<ul style="list-style-type: none"> • Is [Frame Mix] set to a value other than [Off]? → When [Frame Mix] is other than [Off], the images may appear jerky due to the gain-up from [Frame Mix] in low-light environments. To clear this, in [Scene], select a setting other than [Full Auto] (one of [Scene1], [Scene2], or [Scene3]), and set [Frame Mix] to [Off]. 	page 33, page 48
Focusing is not possible in night mode	<ul style="list-style-type: none"> • Are you shooting with visible light? → The focus position is different due to the difference in refractive index between visible light and infrared light. Wavelengths near 850 nm are assumed for infrared light in night mode on this unit. Perform manual adjustment if necessary. 	page 38

Troubleshooting (continued)

Symptom	Cause and solution	Reference pages
1080/29.97PsF images appear jerky	<ul style="list-style-type: none"> • This is normal operation. → In the PsF (Progressive segmented Frame) format, an identical image is captured to fields 1 and 2 in order to output the same image as progressive. Therefore, the image will appear slightly jerky. 	---
1080/25PsF images appear jerky	<ul style="list-style-type: none"> • This is normal operation. → In the PsF (Progressive segmented Frame) format, an identical image is captured to fields 1 and 2 in order to output the same image as progressive. Therefore, the image will appear slightly jerky. 	---
Something is wrong with the coloring of the pictures	<ul style="list-style-type: none"> • Activate the ATW (Auto tracking white adjustment) function. 	page 41
	<ul style="list-style-type: none"> • In some situations, the proper colors may not be reproduced using the ATW function. → In cases like this, proceed with the white balance adjustment. 	pages 40 to 41
The pictures are too light or too dark	<ul style="list-style-type: none"> • Either select the auto setting for the iris or select the manual setting and adjust the iris manually. 	page 38
	<ul style="list-style-type: none"> • The pictures may be dark if the analog video signal cables are too long because this will cause signal attenuation. 	---
Images are in black and white	<ul style="list-style-type: none"> • Is the unit in night mode? → In night mode, output will be in black and white. 	page 49, page 114
Auto white balance adjustment (AWB) is not possible	<ul style="list-style-type: none"> • Is the unit in night mode? → Auto white balance adjustment (AWB) is not possible in night mode. 	page 49, page 114
The screen is too bright in night mode	<ul style="list-style-type: none"> • The aperture is set to open in night mode to prevent video voyeurism. Adjust the brightness at the light source. 	page 38
The iris does not operate in night mode		
The subjects appear distorted	<ul style="list-style-type: none"> • Since this camera uses an MOS imaging device, the pickup timing differs slightly at the top left and bottom right of the screen. This means that if a subject moves quickly across the front of the camera, it may appear slightly distorted. This is not a malfunction. 	---
When the flash is fired during shooting, only the top or bottom of the screen becomes lighter	<ul style="list-style-type: none"> • With a MOS imaging sensor, the pickup timing differs slightly at the top left and bottom right of the screen. This means that when the flash is fired, the bottom of the screen will become lighter in the field concerned and the top will become lighter in the next field. This is normal and not indicative of any problem. 	---
The brightness changes cyclically or the colors change, and horizontal stripes can be seen passing across the screen	<ul style="list-style-type: none"> • These phenomena (flicker) may occur under the illumination produced by fluorescent lighting, mercury bulbs or other types of discharge tubes. Try one of the following in this situation: <ul style="list-style-type: none"> - Set [Flicker Suppression] in the MENU settings to [On]. - Set the electronic shutter speed to 1/100 in regions with a power supply frequency of 50 Hz, and turn the electronic shutter off in regions with a power supply frequency of 60 Hz. 	page 49, page 113
When fine lines or cyclical patterns are shot, flickering is seen or coloring is added to them	<ul style="list-style-type: none"> • This phenomenon occurs because the pixels are arranged systematically on each image sensor. It is noticeable when the spatial frequency of a subject and the pixel pitch are brought into proximity so change the camera angle or take other action. 	---
Noise occurs in the audio input	<ul style="list-style-type: none"> • The following causes are possible. <ul style="list-style-type: none"> - The camera, switching hub, or peripheral devices are not grounded. - Power lines are running nearby. - Equipment generating strong electric or magnetic fields (e.g., television and radio antennas, air conditioning motors, power transformers) are located nearby. <p>If the problem cannot be resolved via movement of surrounding devices, use a microphone equipped with an amplifier, or connect an audio output with low output impedance.</p>	page 6

■ IP images

Symptom	Cause and solution	Reference pages
Images are not displayed	For Windows: <ul style="list-style-type: none"> • Is the plug-in viewer software installed? → Install the plug-in viewer software. 	page 29
	For Windows: <ul style="list-style-type: none"> • If [Check for newer versions of stored pages] is not set to [Every time I visit the webpage] in the temporary Internet file settings, IP images may not appear in the live screen [Live]. → Perform the following. <ol style="list-style-type: none"> ① Select [Tools] - [Internet Options] in Internet Explorer. ② Click the [General] tab, and click the [Settings] button under [Browsing history]. ③ In the [Temporary Internet Files] dialog box, select the [Every time I visit the webpage] option under [Check for newer versions of stored pages]. ④ Click the [OK] button. 	---
The images are blurry	<ul style="list-style-type: none"> • Is the focus properly adjusted? → Check the focus adjustment. 	---
Images are not updated	<ul style="list-style-type: none"> • The images may not be updated and other problems may occur depending on your web browser and its version. • The images may stop depending on the network congestion, the level of access to the unit, etc. • If the IP video settings of the unit were changed, the image display may stop temporarily. → Check the level of access to the unit, and stop any unnecessary access. Afterward, check the following. For Windows: Press the [F5] key on the personal computer's keyboard to request that the settings be acquired. For Mac: Press the [Command] + [R] key on the personal computer's keyboard to request that the settings be acquired. 	---
The images do not update or display properly	<ul style="list-style-type: none"> • Perform the following to delete the temporary Internet files. For Windows: <ol style="list-style-type: none"> ① Select [Tools] - [Internet Options] in Internet Explorer. ② Click the [General] tab, and click the [Delete] button under [Browsing history]. ③ In the [Delete Browsing History] dialog box, select the [Temporary Internet files and website files] checkbox, and then click [Delete]. ④ Click the [OK] button. For Mac: <ol style="list-style-type: none"> ① Select [Develop] - [Empty Cache] in Safari. ② Click [Empty] in the [Are you sure you want to empty the cache?] pop-up screen. 	---
	<ul style="list-style-type: none"> • The unit's ports may be filtered by the firewall or other function of the anti-virus software. → Change the HTTP port number of the unit to a port number that will not be filtered. 	---
H.264 images are not displayed	<ul style="list-style-type: none"> • If the "Network Camera View 4S" plug-in viewer software is deleted in an environment where the "Network Camera View 3" plug-in viewer software is installed, display of H.264 images will become impossible. In such cases, delete "Network Camera View 3" before installing "Network Camera View 4S". 	---
	<ul style="list-style-type: none"> • Has the camera been connected to a personal computer via a router (via the Internet, for example)? → If UDP port transfer has not been set correctly, H.264 images cannot be displayed. H.264 can be transferred by HTTP when [Internet mode(Over HTTP)] is set to [On]. • Has UDP communication been blocked by security software or a firewall? → If [Internet mode(Over HTTP)] is [Off], H.264 is transferred by UDP. → Change the settings in the security software and firewall, and change the settings to permit communications with your web browser. 	page 102

Troubleshooting (continued)

Symptom	Cause and solution	Reference pages
<p>The images are distorted</p>	<ul style="list-style-type: none"> • The images may be distorted if the transmission path is congested and proper transmission is not possible. → Consult your network administrator. 	<p>---</p>
	<ul style="list-style-type: none"> • The images may be distorted if video packet shuffling occurs on the transmission path. → Switching to an identical Internet service provider for both the camera and the personal computer may prevent this problem. Consult your network administrator. 	<p>---</p>
<p>When multiple web browsers are running to display H.264 images, images from multiple cameras appear sequentially in a single web browser</p>	<p>For Windows:</p> <ul style="list-style-type: none"> • This may occur depending on the combination of the personal computer's display adaptor and the driver. → If this occurs, update the first display adaptor to the latest version. If this does not resolve the problem, adjust the hardware accelerator function as follows. This section describes the procedure for Windows 10 as an example. Changing the settings may not be possible, depending on your environment. ① Right-click on the desktop, and select [Display settings] from the menu. ② Click [Advanced display settings]. ③ Select the [Troubleshooting] tab, and click [Change Settings]. ④ Change to [Hardware acceleration] setting to [disable] at the far left, and click [OK]. 	<p>---</p>
<p>Audio is not output for NDI HX-compatible switchers</p>	<ul style="list-style-type: none"> • [Audio] may be set to [Off] in the [Audio] audio setting screen. → Reset the setting to [On]. 	<p>page 110</p>
<p>Images stop in applications that support High bandwidth NDI</p>	<ul style="list-style-type: none"> • When a personal computer and this unit are connected via a commercially available USB LAN conversion adaptor, the images may stop due to network problems on the personal computer side. → If this phenomena occurs, firstly disable the network adaptor that is connecting the personal computer to this unit, then change [Streaming mode] in [Video over IP] to [H.264]. After this, re-enable the network adaptor that you disabled and the images will be output when you change the [Streaming mode] to [High bandwidth NDI]. 	<p>page 100</p>

Troubleshooting (continued)

■ Web screen

Depending on the OS installed on the personal computer, the following may occur. Follow the instructions below when the following has occurred. Performing the following solutions will not affect the operation of other applications.

Symptom	Cause and solution	Reference pages
Frame dropping is observed in images	<ul style="list-style-type: none"> • The personal computer may be lacking in performance. → Check the requirements for the personal computer environment. 	page 8
	<ul style="list-style-type: none"> • This phenomenon may be improved by pressing the button for switching real time updating to disable the web browser real time updating function. 	page 90

For Windows:

The "information bar" described in the following explanations refers to the message bars that appear in Internet Explorer 11. The information bar appears at the bottom of Internet Explorer.



Symptom	Cause and solution	Reference pages
The following message appears in the information bar. "This website wants to run the following add-on: 'WebVideo Module' from 'Panasonic System Networks Co., Ltd.'."	<ul style="list-style-type: none"> • Select [Allow]. 	---
The following message appears in the information bar. "This website wants to install the following add-on: 'nwcV4SSetup.exe' from 'Panasonic System Networks Co., Ltd.'."	<ul style="list-style-type: none"> • Select [Install]. When the security warning window appears, click the [Install] button. 	---
An unnecessary status bar or scroll bar is displayed on the pop-up window	<ul style="list-style-type: none"> • Open the security settings screen for Internet Explorer, and select [Internet]. Click the [Custom level] button, set [Allow script-initiated windows without size or position constraints] to [Enable] under [Miscellaneous], and click the [OK] button. When the warning window appears, click the [Yes] button. 	---
The IP images do not match the display frames	<ul style="list-style-type: none"> • Images may not appear correctly if their DPI settings are 120 DPI or higher. → Right-click on the desktop of the personal computer, click [Display settings] - [Change the size of text, apps, and other items], and select [100% (Recommended)]. 	---
	<ul style="list-style-type: none"> • Images may not appear correctly if the magnification level of Internet Explorer's zoom function is not set to 100%. → Select [View] - [Zoom] in the menu bar of Internet Explorer, and click [100%]. 	---
The layout of the screen is distorted, or some buttons on the screen do not operate	<ul style="list-style-type: none"> • Select [Tools] - [Compatibility View Settings] in the menu bar of Internet Explorer, disable compatibility view for the unit. 	---

Specifications

Power requirements:

12 V DC === (10.8 V to 13.2 V) (Supplied AC adaptor)
42 V to 57 V DC === (PoE++ power supply)

Current consumption:

3.0 A (Supplied AC adaptor)
1.0 A (PoE++ power supply)

 indicates safety information.

GENERAL

Ambient operating temperature:

0 °C to 40 °C (32 °F to 104 °F)

Storage temperature:

-20 °C to 50 °C (-4 °F to 122 °F)

Ambient operating humidity:

20% to 90% (no condensation)

Mass:

Approx. 2.0 kg (4.40 lb) (excluding mount bracket)

Dimensions (W × H × D):

170.0 mm×211.0 mm×171.0 mm
(6-11/16 inches × 8-15/16 inches × 6-23/32 inches)
(excluding protrusions, mount bracket)

Finish:

AW-UE80WP/AW-UE80WE/AW-UE80WED: White
AW-UE80KP/AW-UE80KE/AW-UE80KED: Black

Controller supported:

AW-RP150, AW-RP60

INPUT

Input connector

DC IN 12 V

G/L IN:

BBS (Black Burst Sync), tri-level sync supported
75 Ω terminal (BNC×1)

AUDIO IN:

MIC/LINE input compatible (SDI/HDMI/IP)
AAC compatible (compatible with IP only)
ø 3.5 mm stereo mini jack (unbalanced)

- During MIC input
 - Input level: -40 dBV (0 dB=1 V/Pa, 1 kHz)
 - Plug-in power compatible, supply voltage: 2.5 V ± 0.5 V
 - Input impedance:
 - Approx. 2 kΩ (When plug-in power is ON)
 - Approx. 20 kΩ (When plug-in power is OFF)
- During LINE input
 - Input level: -10 dBV
 - Input impedance: Approx. 3 kΩ
- Input volume variable range:
 - 36 dB to 12 dB (3 dB step)
 - Volume settings can be made independently for left and right.
- Embedded audio output level:
 - 12 dBFS
- Sampling frequency:
 - 48 kHz
- Quantization bit rate:
 - 24bit (SDI, HDMI), 16bit (IP)

OUTPUT

Video output

HDMI:

HDMI 2.0 connector
4:2:2/10bit, 4:2:0/8bit

- HDCP is not supported.
- Viera Link is not supported.

3G SDI OUT:

SMPTE424M/SMPTE292M/75 Ω (BNC×1)

- Level-A/Level-B supported

INPUT/OUTPUT

Input/Output connector

LAN:

RJ-45
LAN terminal for IP control and video transmission
PoE++ power terminal (IEEE802.3bt compliant)

RS-422:

CONTROL IN RS-422A (RJ-45)

FUNCTIONS AND PERFORMANCE

[Camera unit]

Imaging sensors: 1/2.5-type 4K MOS×1

Lens:

Motorized Optical 24× zoom, F1.8 to F4.0
[f=4.12 mm (5/32 inches) to 98.9 mm (3-29/32 inches); 35 mm (1-3/8 inches) equivalent:
25.0 mm (31/32 inches) to 600.0 mm (23-5/8 inches)]
i.Zoom (UHD: 28×, FHD: 36×)

Conversion lens: Not supported

Angle of view range:

Horizontal angle of view: 74.1° (wide) to 3.3° (tele)
Vertical angle of view: 46.0° (wide) to 1.9° (tele)
Diagonal angle of view: 81.8° (wide) to 3.8° (tele)

Optical filter:

Through, 1/4, 1/16, 1/64, IR through
(IR through is used as "Night mode")

Focus:

Switching between auto and manual

Focus distance:

Entire zooming range: 1200 mm (3.9 ft)
Wide end: 100 mm (0.33 ft)

Color separation optical system:

1MOS

Minimum illumination:

3 lx (conditions: F1.8, 59.94p, 50 IRE, 42 dB, without accumulation)

Horizontal resolution:

1500 TV lines Typ (Center area, in UHD mode, at the Wide end)
1000 TV lines Typ (Center area, in FHD mode, at the Wide end)

Gain selection:

Auto, 0 dB to 36 dB (1 dB steps)

- Super Gain function installed: 37 dB to 42 dB

Frame mix:

Auto, 0 dB, 6 dB, 12 dB, 18 dB, 24 dB

- This cannot be configured when the format is 2160/29.97p, 2160/23.98p, 2160/24p, 2160/25p, 1080/29.97p, 1080/23.98p(59.94i), 1080/23.98p, 1080/24p, 1080/29.97PsF, 1080/23.98PsF, 1080/25p, 1080/25PsF.

Specifications (continued)

Electronic shutter speed:

- 59.94p/59.94i mode
1/60, 1/100, 1/120, 1/250, 1/500, 1/1000, 1/2000, 1/4000, 1/8000, 1/10000
- 29.97p mode
1/30, 1/60, 1/100, 1/120, 1/250, 1/500, 1/1000, 1/2000, 1/4000, 1/8000, 1/10000
- 23.98p/24p mode
1/24, 1/48, 1/60, 1/100, 1/120, 1/250, 1/500, 1/1000, 1/2000, 1/4000, 1/8000, 1/10000
- 50p/50i mode
1/60, 1/100, 1/120, 1/250, 1/500, 1/1000, 1/2000, 1/4000, 1/8000, 1/10000
- 25p mode
1/25, 1/50, 1/60, 1/100, 1/120, 1/250, 1/500, 1/1000, 1/2000, 1/4000, 1/8000, 1/10000

Synchro scan:

- 59.94p/59.94i mode
60.00 Hz to 7200 Hz
- 29.97p mode
30.00 Hz to 7200 Hz
- 23.98p/24p mode
24.00 Hz to 7200 Hz
- 50p/50i mode
50.00 Hz to 7200 Hz
- 25p mode
25.00 Hz to 7200 Hz

Gamma: Normal/HD/Cinema1/Cinema2/Still Like

White balance: ATW, 3200K, 5600K
AWB: AWB-A/AWB-B
VAR (selectable between 2000K and 15000K by designating a value)
• ATW Speed variable in 3 steps

Chroma amount variability:
OFF, -99% to 99%

Scene file: Full Auto, Scene1, Scene2, Scene3

Output format

SDI output:

[HD format] 1080/59.94p, 1080/50p, 1080/59.94i, 1080/50i, 1080/29.97p*1, 1080/25p*1, 1080/23.98p*2, 1080/29.97PsF, 1080/25PsF, 1080/23.98PsF, 1080/24p*1, 1080/23.98p*1, 720/59.94p, 720/50p

HDMI output:

[4K format] 2160/59.94p, 2160/50p, 2160/29.97p*1, 2160/25p*1, 2160/24p*1, 2160/23.98p*1

[HD format] 1080/59.94p, 1080/50p, 1080/59.94i, 1080/50i, 1080/29.97p*1, 1080/25p*1, 1080/23.98p*3, 1080/24p*1, 1080/23.98p*1, 720/59.94p, 720/50p

*1 Native output

*2 OVER 59.94i output (your monitor may recognize the signal as 59.94i).

*3 OVER 59.94p output (your monitor may recognize the signal as 59.94p).

Synchronization system:

Internal/External synchronization (BBS/Tri-level sync)

[Pan-tilt head unit]

Installation method:

- Stand-alone (Desktop) or suspended (Hanging)
- To ensure safety, the unit must be secured using the mount bracket supplied.

Camera/pan-tilt head control:

IP connecting cable	<ul style="list-style-type: none"> • When connecting through a PoE++ hub LAN cable*4, max. 100 m (328 ft) • When a PoE++ hub is not used LAN cable*4, max. 100 m (328 ft)
AW protocol connecting cable	LAN cable*4, max. 1000 m (3280 ft)

*4 For the LAN cable, use a category 5e or above, STP (Shielded Twisted Pair) and straight cable.

Pan/tilt operation speed:

Speed range: 0.08°/s to 60°/s (Normal mode)

* 3 speed modes installed

Normal: 60°/s, Fast1: 90°/s, Fast2: 180°/s

- Note that the operating noise may be loud in high speed.
- If the operating noise is disturbing, use the Normal mode.

Panning range: ±175°

Tilting range: -30° to 90°

- Depending on the pan or tilt position, the camera may be reflected in the image.

Quietness: NC25 or less

■ AC adaptor

Input : 100 V to 240 V AC (⤿), 50/60 Hz, 1.2 A
Output : 12 V DC (==), 3.0 A, 36 W

 indicates safety information.

Index

Numerics

×1.0 button	150
3G SDI	60, 62, 93, 95, 96
3G SDI Out	60, 95
3G SDI OUT connector	18
802.1X	135
3200K	41
5600K	41

A

ABB	115
Access level	125, 126
Accessories	11
Activation	144
Adaptive Matrix	52, 117
Add host	126
Address(IPv4)	108, 109
Add user	125
Advanced	130
AF Sensitivity	55, 118
AGC Max Gain	48, 113
All	72
ATW	41
ATW Speed	50, 115
ATW Target B	50, 115
ATW Target R	50, 115
Audio	61, 110
Audio bit rate	110, 111
AUDIO IN connector	17
Audio Level Meter display button	90
Audio over IP	110, 111
Audio transmission	110, 111
Authentication	124, 133
Auto	99
Auto F.Mix Max Gain	49, 113
Auto Iris Speed	47, 112
Auto Iris Window	47, 112
Automatic installation of viewer software	99
Auto port forwarding	131
Auto tracking white adjustment	41
AWB	40, 115
AWB Color TEMP. Info	50, 115
AWB Gain Offset	50, 115

B

Back Light COMP.	49, 113
Backup	146
Bar	61, 96
Basic	93
B Gain	50, 115
Black balance	42
Black level	43
Brightness	47, 48, 49, 112
Button for displaying the Image Adjust operation screen for touch panels	147
Button for displaying the operation menu for the live screen	150
Button for displaying the Preset operation screen for touch panels	147
Button for displaying the PTZ operation screen for touch panels	147
Button for restoring the screen from the touch panel operation screen	147
Button for switching P/T Speed/Zoom	150
Button for switching PTZ/Focus	150
Button for switching real time updating	90
Button for switching the personal computer screen	90, 150
Buttons for switching the touch panel operation screen	147

C

Cable clamp	18
CA Certificate	
CA Certificate install	132, 140
Generate Certificate Signing Request	131, 139

Information	132
CA Certificate install	136
Camera	46, 47, 70, 144
Camera Control	149
Camera control/Setup Menu button	111
Camera head	16
Camera menu	46, 76
Camera title	99
Camera title display area	90
Check active network setting	129
Chroma Level	51, 115
Chroma Phase	51, 115
Client	123
Client(Caller) port	106
Client certificate install	135
Client certificate type	135
Cloud URL	124
Color bar	87
Color Bar Type	61, 96
Color Correction	53, 54, 117
Color Temperature	50, 115
Common	128
Common setup	106
Compression	87
Config data type	146
Connect	74
Connection	132, 140
Connection type	122
Contact	134
Control Area	150
Control pad and its buttons	89
CPU Software	70, 144
CRT key generate	131, 138

D

Date & Time	143
Date/Time	99
Date&Time	99
Day/Night	49, 114
DC IN connector	17
Default gateway	127
Default Gateway	71
Default reset	145
Delete host	126
Delete user	125
Description	143
Destination port	106
Destination URI	106
Detail	51, 115
Detail Coring	51, 115
DHCP	127
DHCPv6	127
Digital Extender	55, 118
DNR	52, 116
DNS	127
Download	146
Drop-prevention wire	16
DRS	51, 116

E

EAP authentication method	135
Easy IP Setup accommodate period	128
Easy IP Setup Software	27
Easy IP Setup Tool Plus	136
EasyIP Setup Tool Plus	27
EEPROM	71, 144
ELC Limit	48, 113
Enc	71, 144
Encryption	106
Encryption method	133
Error code	143
Error description	143
Error log	143
Error Status	70, 75

Index (continued)

Event code	143
Event log	143
Expansion panel display button	86
External Output	63, 97
External sync signal input format	17

F

Fall Acceleration	65, 67, 98, 121
Fall Ramp Time	68, 121
Fall S-Curve	64, 67, 98, 121
Fan	57, 73, 75, 93, 94
Firmware file	144
Firmware version	144
Firmware Version	70, 71, 92
Flicker Suppression	49, 113
Focus	38, 89
Focus Adjust With PTZ	63, 93, 98, 120
Focus (AUTO)/Iris (AUTO) button	150
Focus Mode	55, 118
Format	56, 58, 60, 61, 74, 93, 95, 96, 109
FPGA	71
Frame Mix	48, 113
Frame rate	103, 105
Freeze During Preset	67, 122
Frequency	56, 58, 93
From	72, 111
Full Auto	72
Full-screen display button	90

G

G	62, 97
Gain	38, 48, 90, 113
Gamma	51, 116
Gamma Mode	51, 116
Genlock	44, 56, 93, 94
G/L IN connector	17
Ground connector	18
Grounding	6
Group	108, 109

H

H.264	100, 102
H.264 transmission	102
H.265	100, 104
H.265 transmission	104
HDMI	61, 62, 93, 96
HDMI connector	18
HDMI Status	70, 74
High bandwidth NDI	109
Hole for securing the camera pedestal	16
Home button	150
Horizontal Phase	56, 93, 94
Horizontal phase adjustment	44
Host auth.	125
Host IP address	125
Hour Meter	70, 73
HTTP max segment size (MSS)	128
HTTP port	128
HTTP Port number	130
HTTPS	131, 137, 140
HTTPS mode	132
HTTPS port	132
HTTPS Port number	130
HTTPS Status	130
HTTP Status	130

I

Image adjust	111
Image adjust operation area for touch panels	148
Image/Audio	100
Image capture size	101, 103, 104
Image quality	102, 103
Index number	134

Initial account	28, 84
Initial display setting	100, 101
initialization	73
Initialize	70, 72
Input Type	61, 110
Install Position	26, 63, 93, 97
Internet mode(Over HTTP)	102
Invert Pan/Tilt Axis	57, 123
IP	57
IP address	126
IP Address	71
IP address(IPv4)	123, 127
IP address(IPv6)	127
IP/NDI/HX	62, 96
IP Network	70, 71
IP out	123
IP(UDP)	123
IPv4 network	127
IPv6 network	127
IP video transmission output	20
IR ID switches	18, 26
Iris	38, 89
Iris Limit	47, 112
Iris Mode	47, 112

J

JPEG	100, 101
JPEG transmission	101

K

Knee Mode	51, 116
-----------------	---------

L

LAN connector for IP control	17
Latency	106
Lens	47, 55, 70, 75, 118, 144
Limitation Setting	120
Limiters	151, 152
Linear Matrix	53, 117
Linkage	122
Live	85, 86
Live page	99
Location	134
Lock	88
Logic	71, 144

M

MAC address	144
Main area	88
Main/Network	70, 71, 144
Maintenance	46, 70, 143
Manual	99, 127
Manual shooting	38
Master Detail	51, 115
Master pedestal	43
Master Pedestal	51, 115
Matrix	47, 52, 53, 54, 117
Matrix Settings	117
Matrix Type	52, 117
Max bit rate(per client)	103, 105
Max Digital Zoom	55, 118
Max RTP packet size	128
mDNS	135
Memory	99
Mode	100, 106, 124, 125
Model no.	92, 144
Monitor	74
Mount bracket for installation surface	16
Multicast address	104, 105
Multicast address(IPv4)	107
Multicast port	104, 105
Multicast Port	107
Multicast Transmit	108, 109

Index (continued)

Multicast TTL/HOPLimit 104, 105, 107

N

Name 108, 109
ND 90
ND Filter 49, 114
NDI 62, 96
NDI|HX 108
NDI|HX V2 108
Network 71, 126, 144
No. 143
NTP 99, 130
NTP port 130
NTP server address 130
NTP server address setting 130

O

O.I.S. Mode 55, 118
Operation 73
Operation screen display buttons 86
Operation time 143, 144
Optional accessories 11
OSD Menu 87
OSD Mix 62, 96
OSD Off With R-Tally 62, 96
OSD Status 62, 97
OSS license display 144
Other Menu 87
Output 46, 60, 61, 62, 63, 93, 95
Output1 63, 97
Output2 63, 97
Output client select 123
Output conditions for each video format 19

P

P2 Cast 124
Pan head 16
Pan/Tilt 46, 63, 75, 93, 97
Pan/Tilt Lens Control 120
Passphrase 106
Password 124, 125, 134, 136
PC Synchronization 99
PEAP 136
Phase 53, 54, 117
Picture 47, 50, 51, 114
Picture Level 47, 112
Plain text usage 136
Plugin Power 61, 110
Plug-in viewer software 29
Port 124
Power 31
Power cable 11
Power ON 88
Power On Position 64, 98
Preset 46, 66, 67, 89, 119
Preset Acceleration 67, 120
Preset Acceleration Setting 66
Preset Digital Extender 66, 121
Preset Iris 67, 122
Preset memory 39
Preset Name 66, 121
Preset Number 64, 98
Preset operation area for touch panels 148
Preset position 119
Preset Scope 66, 121
Preset Setting 120
Preset Shutter 67, 122
Preset Speed 66, 120
Preset Speed Table 66, 120
Preset Speed Unit 66, 120
Preset thumbnail list display button 90
Preset thumbnail operation area 150
Preset Thumbnail Update 66, 121
Preset Zoom Mode 67, 122

Primary server address 127
Privacy Mode 63, 98
Private Key password 135
Private Key password usage 135
Product info. 144
Profile type 102
Protocol 108, 109
P/T Acceleration 64, 97
P/T Acceleration Setting 63, 97
P/T Speed Mode 63, 93, 97
P/T Speed/Zoom operation area 150
PTZ/Focus operation area 150
PTZ operation area for touch panels 147
Push UDP 107

R

R 62, 97
Reboot 145
Recommended network setting for internet 129
Referrer check 134
Refresh interval 102
Remote control IDs 26
Reset to the default (Except the network settings) 145
Retype password 125
R Gain 50, 115
Rise Acceleration 64, 67, 98, 121
Rise Ramp Time 68, 121
Rise S-Curve 64, 67, 98, 120
Router global address 130
RS-422 connector 17
RTMP 105
RTSP 133
RTSP port 133
RTSP request URL 133

S

Safe mode 153
Saturation 53, 54, 117
Scene 47, 90, 111
Scene1 72
Scene2 72
Scene3 72
Scene All 72
Scene Copy 70, 72, 111
Scene file 33
Secondary server address 127
Security certificate 141
Self-signed Certificate
 Generate 131, 138
 Information 131
Serial 56, 122
Serial no. 144
Server address(IPv4) 108, 109
Server setup 105
Server URL 105
Service switches 18
Servo 70, 144
Set Execute 71
Setting status 92, 100, 110, 122, 124, 125, 130
Setup 45, 85, 91
Shooting 30, 35
Shooting mode 33
Shutter 90
Shutter Mode 48, 112
Shutter speed 38
Skin Detail 51, 116
Skin Detail Effect 51, 116
Smoother live video display on the browser(buffering) 99
Snapshot button 90
Snapshot button for touch panels 147
SNMP 133
Source name 108, 109
Speed 89
Speed With Zoom Position 63, 93, 98, 120

Index (continued)

Spot Light COMP.	49, 113
SRT	106
SRT/MPEG2-TS/RTMP	90
SRT/MPEG2-TS/RTMP operation area for touch panels	147
Standby	88
Status display lamp	16
Status Lamp	63, 97
Step/Synchro	48, 112
Stream	87, 101
Stream ID	106
Streaming format	105, 107, 108
Streaming mode	92, 100
Stream key	105
Stream Menu	87
Subnet(IPv4)	108, 109
Subnet mask	127
Subnet Mask	71
Super Gain	48, 113
Synchronization with NTP	130
System	46, 56, 57, 93
System Format	92
System Frequency	92
System log	143
System name	134
System status	93
System Version	70

T

Tally	62, 97
Tally Brightness	62, 97
Tally lamp	16
Tally LED Limit	62, 97
Temperature	75
Time adjustment interval	130
Time Zone	99
TLS	135
TLS User name	135
To	72, 111
Tone	61, 96
Top Menu	46
Tracking data output	59
Tracking Data Output	56, 122
Transmission priority	103
Transmission type	103, 105, 107
Tripod screw holes	18
TSL5.0	134
TSL5.0 Port	134
TTL/HOP Limit	106, 108, 109

U

Unicast address(IPv4)	107
Unicast Port	107
Unicast port(Audio)	104, 105
Unicast port(Image)	104, 105
Upload	146
UPnP	131
URL	105
URL type	105
Use discovery server	108, 109
User auth.	124
User ID	124
User mng.	124
User name	125, 133, 136

V

VAR	41
V Detail Level	51, 115
Ventilation holes	16
Video over IP	100
Video Sampling	61, 74, 96
Viewer software installation counter	144
Volume Level CH1	61, 110
Volume Level CH2	61, 110

W

WB	90
Web screen	83
White balance	40
White Balance Mode	50, 115
White Clip	52, 116
White Clip Level	52, 116
Wireless Control	57, 93, 94
Wireless remote control	15, 24, 26
Wireless remote control signal light-sensing area	16

Z

Zoom	89
Zoom Mode	55, 118

Panasonic Corporation

Web Site: <https://www.panasonic.com>

© Panasonic Corporation 2022