

R || RIEDEL

Welcome

欢迎

Willkommen

Bienvenue

Benvenuti

ようこそ!

نيرونم

Bem-vindos

Καλώς ήρθατε

Bienvenidos

Table of Content

About Riedel Communications.....	6
Creating Sustainable Value through Technology Leadership.....	8
The Riedel Cosmos.....	10
Live Video Production.....	12
SIMPLYLIVE PRODUCTION SUITE Multi-camera production re-imagined.....	14
ALL-IN-ONE.....	16
VIBOX SLOMO.....	18
E-SLOMO.....	20
REFBOX.....	22
VIBOX BMR.....	24
RIMOTION R6 / R8 / R12 / R84: Replay Solutions for Everyone.....	26
RICAPTURE I4 / I4 ADVANCED.....	32
VENUE GATEWAY.....	34
MEDIORNET Distributed Video Network.....	36
MEDIORNET Distributed Video Infrastructures for Routing, Multiviewing & Processing.....	38
MEDIORNET Applications.....	40
Meet the MediorNet Family.....	46
MEDIORNET Specifications Overview.....	52
RILINK Global Network Services.....	54
RILINK – IP MEDIA WAN.....	56
RILINK – Direct Internet Access.....	57
RILINK References (selected).....	58
ARTIST Digital Matrix Intercom.....	60
ARTIST EcosystemThe Advanced Communications Platform.....	62
ARTIST – System Overview.....	63
ARTIST-1024 The Next Piece of the Puzzle.....	64
ARTIST at a Glance.....	66
DIRECTOR Intuitive Configuration Software.....	68
Add-on Features.....	69
RIEDEL SmartPanels – The Multifunctional User Interfaces.....	70
1200 Series SmartPanel.....	72
The smartest SMARTPANELS™.....	73
2300 Series SmartPanel.....	76
SmartPanel Apps.....	80
Intercom Goes Commentary: Riedel Commentary Control Panel.....	82
BOLERO Digital Wireless Intercom.....	84
BOLERO – Riedel's state-of-the-art wireless intercom system.....	86
Intercom Accessories.....	92
Network Interfacing.....	94
Network Stream Adapters.....	94
Partyline Interfacing.....	95
Radio Interfacing.....	95
Headsets.....	98
Comfortably functional... Headsets for Intercom & Radio Applications.....	100
Services.....	104
Riedel Services.....	106
Consulting.....	106
Commissioning.....	106
Riedel Academy.....	107
Riedel Care.....	108
Distributed Service & Support.....	108
Warranty & Extended Warranty.....	110
Software Updates.....	111
Software Upgrades.....	111
Overview of Services and Support.....	112



Dear valued client,

If we at Riedel have learned just one thing after three decades in the broadcast and event technology business, it's that we have to constantly evolve in order to remain the innovative and passionate company that you know us to be.

Our industry experiences disruptive technological change on a regular basis, providing equal amounts of excitement and headache, but also opportunity. And we expect to see even more radical changes over the coming years, both in terms of new technologies like IP and VR, and in how audiences experience and consume content.

The worlds of broadcast, sports, and entertainment are continuing to converge and we see it as our mission to help guide you through these changes, with ideas and customized solutions all from a single source. As a manufacturer and system provider with a 360-degree view, we want to be your partner now and for the future.

We look at technology from the perspective of usability. Our goal is to make life as easy as possible for you. We aspire to create solutions that perfectly fit your needs and expectations, not only in terms of the physical hardware and software, but also for service, expertise, commitment, and passion.

We also understand that the tools that you use to do your job can be complicated and we work tirelessly to create user interfaces that free you from the complex technical details and allow you to be more efficient and effective at telling unique and compelling stories.

As the former Chief Designer of Braun, Dieter Rams said, "Good design is the sum of well-resolved details." We believe that technology should adapt to people and their needs, not the other way around.

We will continue to be innovative. We will continue to be game-changing. We will continue to be by your side, wherever the road leads.

We are over 800 employees in over two dozen offices with six engineering hubs worldwide.

We are RIEDEL.

A handwritten signature in blue ink, appearing to read 'Thomas Riedel'.

Thomas Riedel



Creating Sustainable Value through Technology Leadership

Riedel designs solutions to meet your highest expectations and demands. That philosophy has been in place since we began nearly 30 years ago. Today, we are focusing on it more than ever, as few industries develop as dynamically as broadcast, media, and entertainment. It is now very clear that IP will be the driving force for the foreseeable future and as technological innovations are changing our market, both manufacturers and users will face new challenges.

We at Riedel have understood the need for a paradigm shift in terms of developing future integrated solutions for video and audio infrastructures, including the next generation of intercom solutions. We offer flexible solutions for today's and future standards in the broadcast environment that are perfectly matched to your needs and expectations. We want to support this challenging paradigm shift to ensure a smooth transition for you into the new world of IP broadcast.

Riedel has always created sustainable value through technological leadership. Hence, all our current solutions are already based on IP architectures. At the same time, we continue to support all the legacy interfaces. With Riedel's "plug and play" feature set, you will be able to continue operating our new systems like you do with our current gear. We are already introducing you, step by step, into this new world of IP-based media infrastructures. These infrastructures and more standardized hardware will help you to reduce operational costs, enhance workflow efficiency, and create more networking opportunities. And this will enable more powerful production and delivery environments.

Our flexible systems offer you an integrated approach with maximum connectivity options on your standard of choice while providing seamless workflows and ease of use. By supporting layer 1, 2 (such as AVB), and 3 (such as AES67 for audio or SMPTE 2022 for video) interfaces, we will integrate all three transport layers into one solution to maintain maximum flexibility and to achieve compatibility at the same time.

We are ready for the future. Our goal is to make your investments safe and to support you on your path towards the brave new world of IP-based media infrastructures.

The Riedel Cosmos

Riedel is a leading provider of live production tools in the worlds of media, sports and entertainment. Our hard- and software solutions span from distributed video and audio networks over intercom and replay solutions to WAN and MPLS applications. Thanks to our holistic approach, our three business units Product Division, Managed Technology Division and Networks Division can leverage powerful synergies to provide the infrastructures, tools and services for both fixed and temporary installations around the globe, enabling our customers to run even the most complex projects - on-site, remotely, or in the cloud.

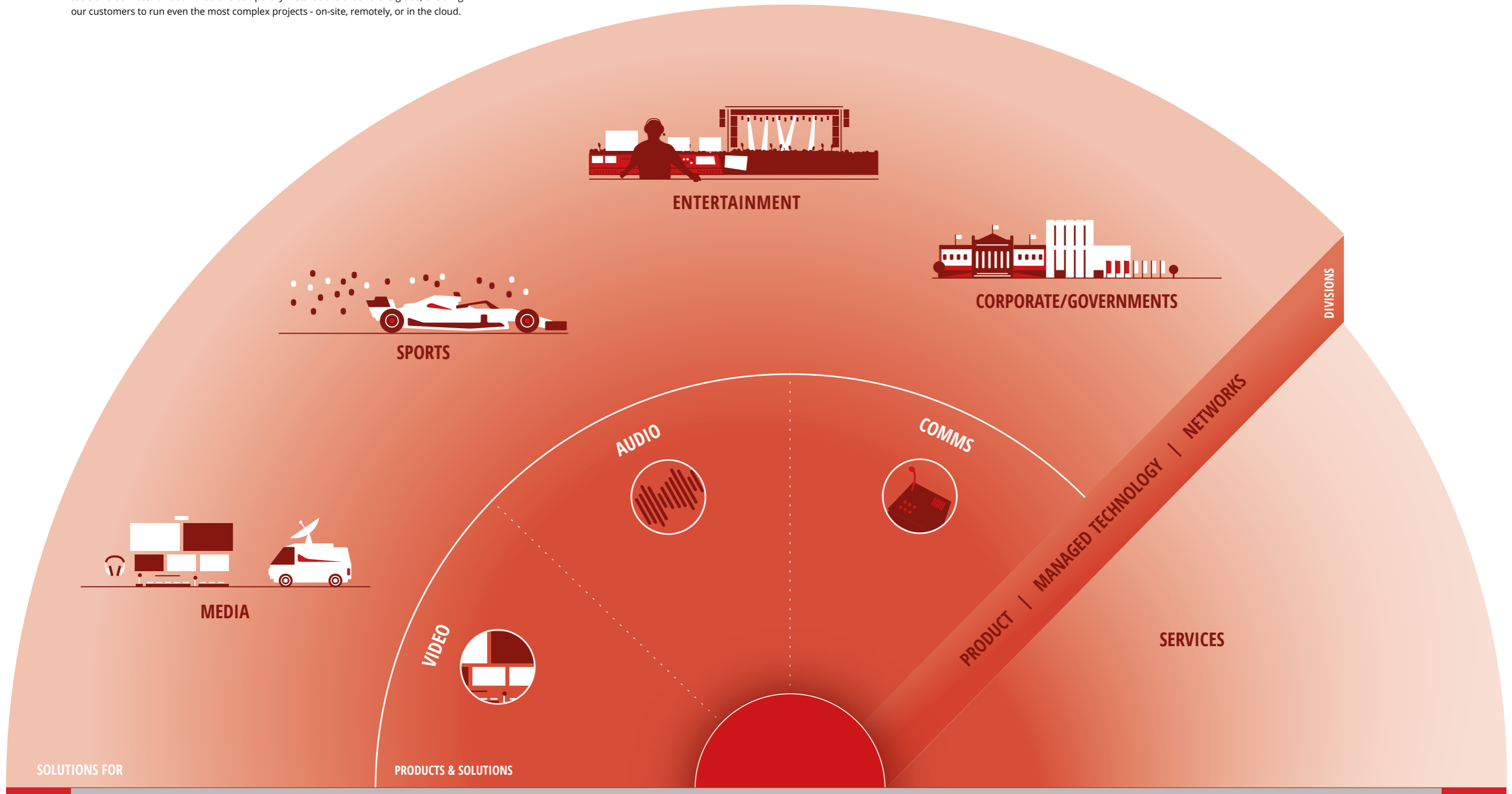

LIVE VIDEO PRODUCTION



SIMPLYLIVE PRODUCTION SUITE MULTI-CAMERA PRODUCTION RE-IMAGINED.

The Simplylive Production Suite is a software-driven live production platform that lets you choose from a range of application layers, tuned to the tasks you need to do – from live replay, ingest recording, streaming or video review to an all-in-one production solution that gives you virtually everything you need to create a show.

This highly modular solution is as flexible as you are: the Simplylive Production Suite lets you add personnel to cover large events — or shrink it to a oneoperator show, if needed. It is connective to all of today's video formats (SDI, NDI etc), and intrinsically migratable to the IP and cloud universe.

Live switching cameras and video sources, cueing and scrubbing slowmo replays, controlling audio, or adding graphics – using a single touchscreen interface. Today's new generation of producers understand the need to create more high-quality content for expanding niche markets, but with limited budgets. Whether for sports, news, or live talk programs, the Simplylive Production Suite is their platform of choice.



ViBox UHD / HD Servers

Choose your ViBox Server...

ViBox servers are the foundation of your Live Production Suite. So selecting your Production Suite configuration starts with answering two basic questions:

- What do you want to do?
- How much power do you need?

The first answer shows which application layers you'll interact with.

You can use the Suite simply as a live replay system, a ingest recorder, a live streaming output — or, as total production control for multi-source video and audio.

The second answer defines your architecture needs, in terms of processor performance, storage and input/output. Are you just live-streaming online with 1080p content at standard frame rates? Or are you sending UHD at 60p with extensive super slowmo? Do you need bespoke hardware for a traditional on-site production? Or do you need to implement a remote production within a private data center or the public cloud? Since everything about the Simplylive Production Suite is based on a modular software architecture, we have the right solution for you.

... or go straight into the Cloud!

The Simplylive Production Suite has revolutionized the industry with a game-changing software-defined approach that offers a seamless transition to a full cloud platform. Its highly intuitive and collaborative workflows can easily be deployed on private or public cloud instances with scalability and power tailored to the production at hand.

The cloud production platform can be easily customized from template selections, based on the number of video I/Os, replay positions, multiviewer connections, commentary positions and intercom needs.

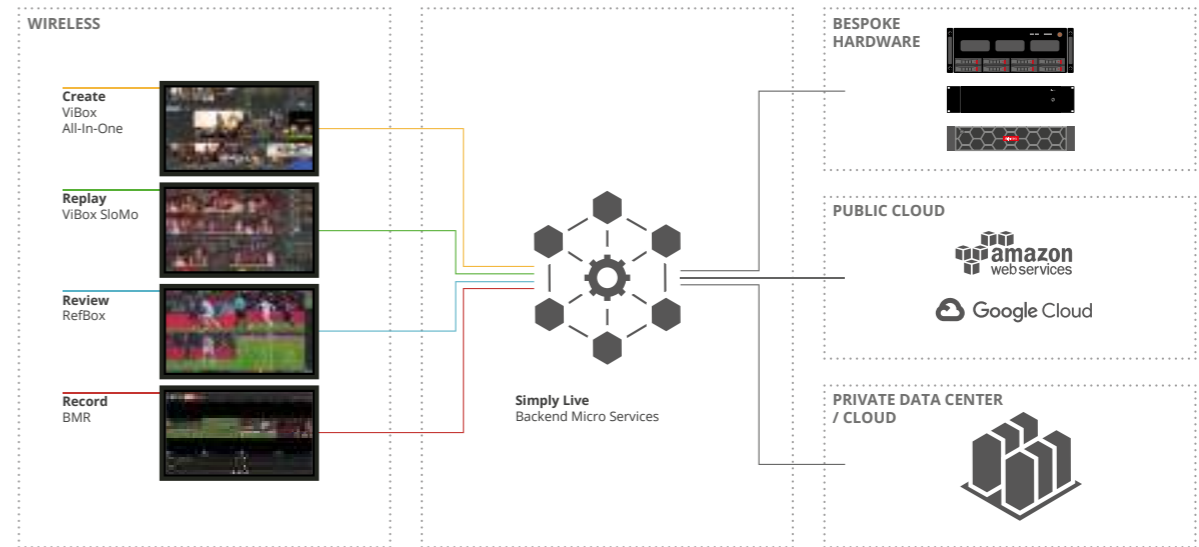

ALL-IN-ONE

ViBox All-In-One is the world's most flexible total production tool for multi-camera programs of all sizes.

How flexible, you ask? Well, on Friday, you can produce a game with just one user controlling all the main elements of live production - live switching, graphics, live replays, highlights and audio mixing - while on Sunday, you can use the same solution to produce larger games that need a multi-user workflow. The first operator can be switching the show on one touchscreen, another operator is running a ViBox SloMo application, and a 3rd UI also has SloMo running for a 2nd replay operator.

In developing the Simplylive Production Suite user interface, we studied hundreds of live production workflows and run-downs to design a system that anyone can use. We made sure that all the tools you need to tell a great story are right where you need them to be.

Features

- » Remote workflow capable
- » Highly scalable workflows
- » Picture in Picture (PIP)
- » 3 keyable graphic layers
- » External NDI graphics integration
- » 32 audio preset snapshots
- » 32 manual transition macros
- » 1000 possible playlists
- » Import/export of content
- » Keywords/Tagging
- » Keyboard shortcuts for external control options



ViBox All-In-One UI

Benefits

- » **Create great sports with ease** - Smart user interface built around a touch-screen workflow that removes the worry of operating and learning complicated equipment.
- » **Work the way your production demands** - Allows a single operator to run a complete production on a single touch-screen, or have multiple operators working on up to 3 different functions in a production...
- » **Reduce costs with remote production** - Locate your server with the cameras at the venue, but have your operators run the touch-screens from wherever you want.
- » **Work with best-in-class systems** - Easily work with other specialized systems for graphics and audio mixing. Any NDI capable graphics system can feed in keyable graphic layers. The same goes for Dante capable audio mixers feeding final mixes to A-I-O.
- » **I/O choice means production flexibility** - select SDI, NDI, RTMP, TS UDP, and native SRT sources for your inputs. You can also use higher frame rate, super motion camera sources to offer the highest quality replays.
- » **Easily localize your programs** - Send a single camera feed with clean audio downstream and add localized V/O, graphics and clips to engage more audiences across the globe.

ViBox UHD A-I-O	ViBox 16 A-I-O	ViBox 12 A-I-O	ViBox 8 A-I-O
Up to 12 bidirectional UHD channels	Up to 16 bidirectional channels	Up to 12 bidirectional channels	Up to 8 bidirectional channels
Multi-user workflow capable	Multi-user workflow capable	Multi-user workflow capable	Multi-user workflow capable
Integrated SloMo, GFX & audio	Integrated SloMo, GFX & audio	Integrated SloMo, GFX & audio	Integrated SloMo, GFX & audio

Add-ons

Xport Software

Automated or manual export of your clips and playlists to network attached or local storage for archiving and repurposing media.

VDR Panel

Web-based UI with expanded multi-channel control for clip playback, program delays, monitor wall playback and many other scenarios.

Web Commentator

Full web-based UI for audio commentary from remote talent, with an integrated low latency program multiviewer.

Web Multiviewer

The Web Multiviewer offers low latency, web browser video and audio multiviewers for local and/or remotely located users.

BMR Software

Iso-recorder for all inputs and program outputs that allows to encode and stream your production to the web utilizing standard protocols.

VIBOX SLOMO

Ultra Intuitive and Scalable Replay

ViBox SloMo is most intuitive and scalable replay system on the market. The system is designed for high quality live sports productions of any size.

How many cameras does your production have? Four in HD? How about 12 cameras or six in UHD? We let you do it all. For larger productions, ViBox SloMo can scale up to dozens of HD cameras across a network of ViBox SloMo servers fed to multiple UIs. With all that choice, operators can decide the camera layouts they need.

**REPLAY FOR EVERYBODY,
EVERYWHERE – EVEN IN THE CLOUD**

ViBox SloMo is also designed for the way operators want to work. Some may prefer the familiar SloMo remote control with an intuitive button layout and a jog wheel. Others love working with our touch-screen UI with its easy-to-access controls and great feeling scroll pad. And some operators want to work with both at the same time... ViBox SloMo does it all.

Intuitive. Reliable. Scalable. Your replay operators will love working with ViBox SloMo and your directors will love the way it looks.

Features

- » Remote Workflow Capable
- » Highly Scalable
- » Up To 15 Inputs / up to 6 Outputs
- » Super Motion Recording (up to 8x SSM)
- » 1000 Playlists
- » Export Playlists
- » Keywords/Tagging
- » Import/Export of Content
- » Remote Controller Option
- » PiP Clock Overlay Option
- » Animated Graphic Wipes/RTDs
- » Multiple Replay Source Layouts

Multi-Server Multi-User Workflow

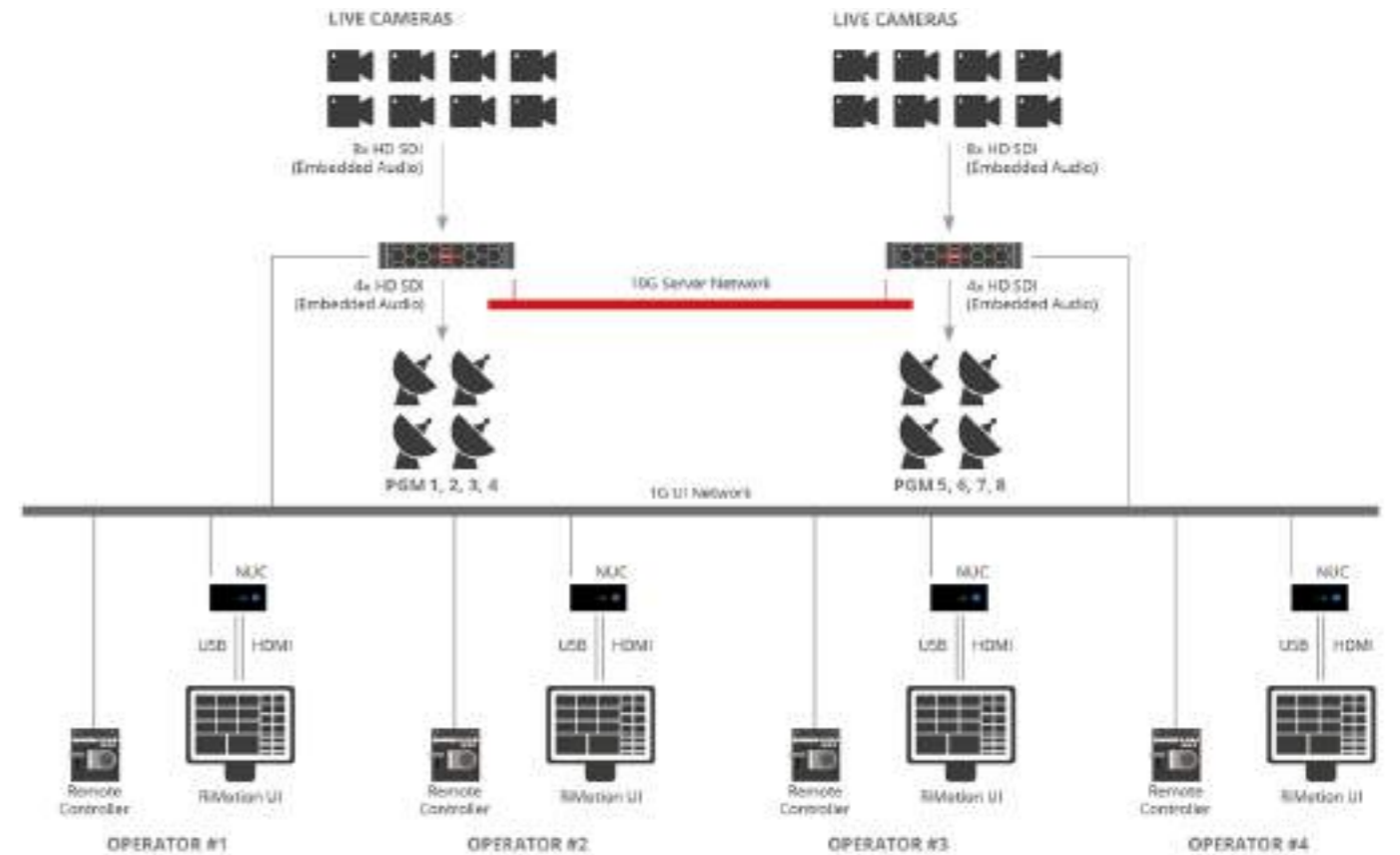

ViBox UHD SloMo	ViBox 16 SloMo	ViBox 12 SloMo	ViBox 8 SloMo
Up to 11 UHD inputs	Up to 15 inputs	Up to 11 inputs	Up to 7 inputs
Up to 4 outputs	Up to 6 outputs	Up to 6 outputs	Up to 6 outputs
Multi-user capable	Multi-user capable	Multi-user capable	Multi-user capable
Multi-server expandable	Multi-server expandable	Multi-server expandable	Multi-server expandable
Remote workflow capable	Remote workflow capable	Remote workflow capable	Remote workflow capable

E-SLOMO

Revolutionary AI Driven Super Slow-Motion
for Live Production, Post, and Archive

e-Slomo is a revolutionary software application that uses artificial intelligence to create super slow-motion sequences from standard camera footage. It's the perfect tool to create emotive promos, openers and closers, or to give new life to your archived content – all at a fraction of the cost of dedicated high frame rate cameras.

e-Slomo software can be used both online and offline and can be installed on premise or in the cloud, making its deployment very flexible. The creation of e-Slomo clips is extremely fast, requiring only a couple of seconds of buffering time. Simply cue the start of your replay, send it to e-Slomo, and in moments your super slow-motion sequence will be ready for broadcast.

e-Slomo is fully compatible with our complete range of live video production solutions, and integrates seamlessly into any replay, studio, or post-production workflow. Deployable on premise or in the cloud, this tool allows to create super slow-motion content from any remote location – even from home.

Features

- » AI-driven, leveraging the latest generation of Nvidia GPUs
- » Deployable on premise or in the cloud
- » Various formats, including 720p, 1080i, 1080p, and UHD
- » Use with ViBox SloMo to provide instant super slow-motion in your live environment

e-Slomo ViBox Example Workflow

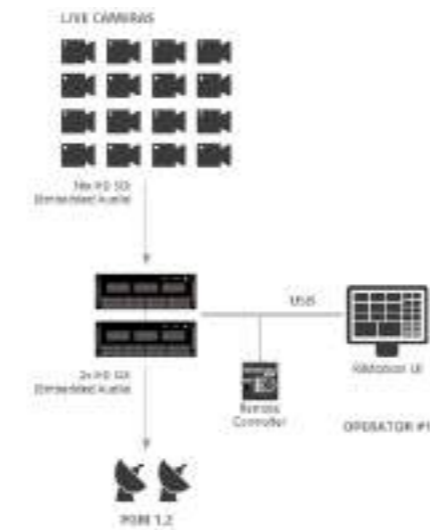

e-Slomo User Interface

REFBOX

Flexible, Affordable Video Review

The RefBox video review has all the essential capabilities that you'd expect in a typical review system for sporting officials on the courts or coaches in the locker rooms – but is equally suitable for multi-camera review in medical or security applications. Up to 25 cameras are in sync. It's easy to swipe through a shot on the touch-screen UI – just touch the screen to select multiple angles to compare, pinch and zoom into the shot. Easily run through the action frame by frame on the screen.

The biggest difference between RefBox and other review systems is that you can run other Simplylive applications on the same platform. That means on Friday, the system can be used for referee review at the basketball game. On Saturday, the same system can be an All-In-One production system for the football game. During the week, the coaches can analyze players performance back on RefBox. What if you need both live production capability and official review at the same time? Not a problem – the Simplylive Production Suite has the power to easily manage both of these critical tasks.

Features

- » Super Motion Recording
- » Multiple Layouts
- » All Angles Pinch & Zoom
- » Browse, Search & Play @ Different Speeds
- » Remote Workflow Capable
- » Multiple Users
- » Flexible User Roles
- » Export to Multiple Formats
- » PiP Clock Overlay Option
- » Keywords/Tagging
- » Remote Controller Options

RefBox Remote Central Review Workflow Example

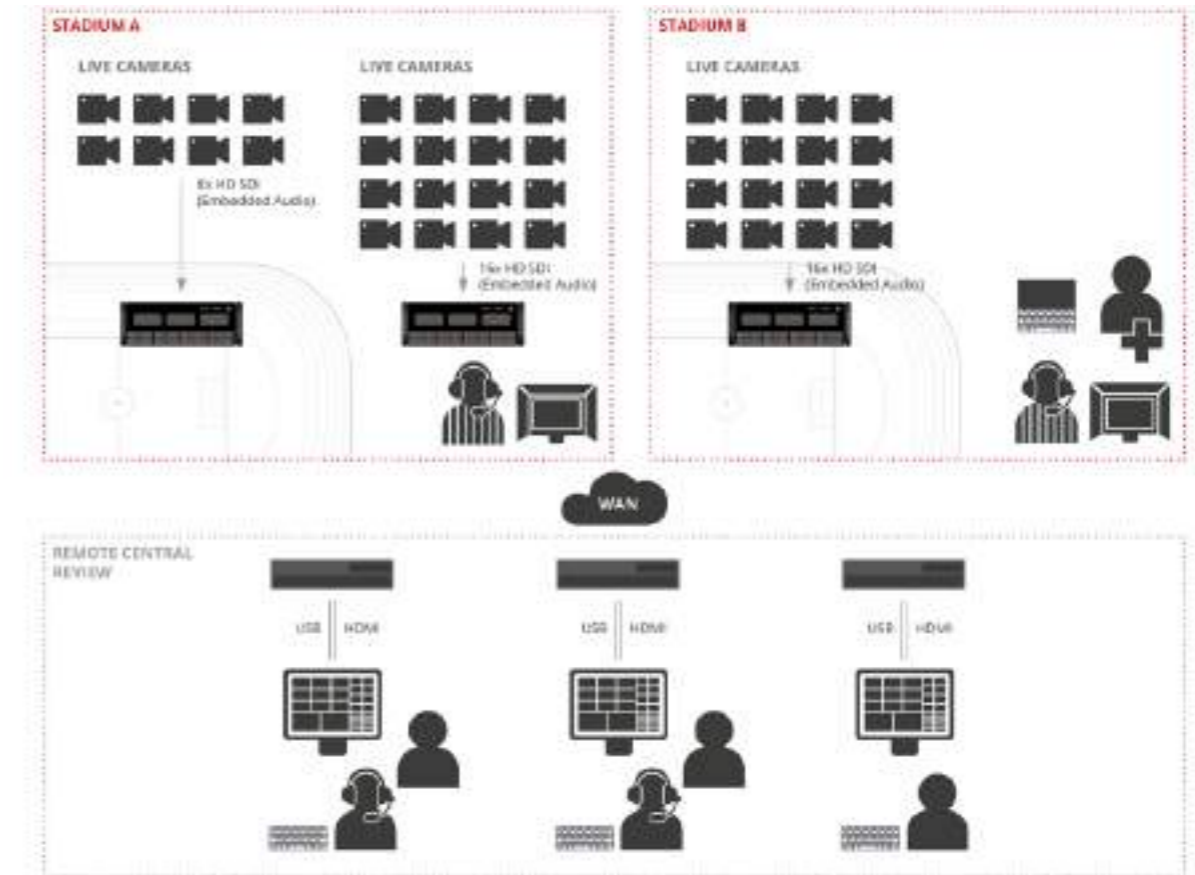

RefBox UHD	RefBox 16	RefBox 12	RefBox 8
Up to 12 UHD source inputs	16 source inputs	12 source inputs	8 source inputs
Multi-user and remote workflow capable	Multi-user and remote workflow capable	Multi-user and remote workflow capable	Multi-user and remote workflow capable
Multi-server expandable for additional source cameras	Multi-server expandable for additional source cameras	Multi-server expandable for additional source cameras	Multi-server expandable for additional source cameras

VIBOX BMR

Flexible & Integrated Ingest Recorder

The ViBox BMR ingest recorder offers a flexible set of features going far beyond the average master and ISO recording system.

ViBox BMR is fully integrated into the Simplylive Production Suite. Depending on which ViBox server you have, BMR can be running transparently on the same system and recording at the same time as other Simplylive applications. Or use that same ViBox system to run other Simplylive applications...like multiple ViBox SloMo applications, or SloMo with a RefBox Review application.

ViBox BMR doesn't just record locally. It can record to network-attached storage, FTP sites and live stream to the web - all at the same time.

Features

- » Simultaneous multi-destination streaming to local storage system (USB, HDD), network storage system (SAN, NAS) and FTP
- » Simultaneous web streaming - H.264 and H.265 codecs utilizing RTMP or HLS
- » Primary Record Codec - DNxHD and other flexible options
- » Remote workflow and multi-application capable



BMR - 8 UI



BMR UHD	BMR 16	BMR 12	BMR 8
8 UHD source inputs	16 source inputs	12 source inputs	8 source inputs
Multi-user and remote workflow capable	Multi-user and remote workflow capable	Multi-user and remote workflow capable	Multi-user and remote workflow capable
Multi-server expandable for additional source cameras	Multi-server expandable for additional source cameras	Multi-server expandable for additional source cameras	Multi-server expandable for additional source cameras

RiMOTION

R6 / R8 / R12 / R84: Replay Solutions for Everyone

Riedel RiMotion live replay solutions are the most intuitive and scalable options in the market, breaking with traditional concepts and bringing a modernized user experience to live replay.

Defined by a compact form factor and significant cost advantages, RiMotion represents the high quality and professional approach all our products are known for.

RiMotion solutions are available in four different bundles, so you'll find just the right one for your production. With RiMotion R6, R8 and R12 you get to choose from 6 to 12 configurable channels for 4 to 10 camera inputs. And R84, the latest addition to the RiMotion family, adds UHD support with 4 UHD channels and up to 8 1080p HDR channels.

Riedel RiMotion offers a pioneering solution combining extensive slow-motion capabilities, including super slow-motion (SSM) camera support, with Simplylive's acclaimed touchscreen UI approach.

The intuitive user interface that has become a landmark of the ViBox product range, has been further optimized for RiMotion. All features are concentrated in a clear and simple to use touchscreen interface, that even new users can learn to operate

SEE IT. LOVE IT. REPLAY IT.

in minutes. Additionally, the system comes with a dedicated RCU slow motion remote controller (RCU), integrated with the touch UI. This allows the best operator experience with the combination of the dedicated remote and touchscreen interface.

RiMotion is designed for the way operators want to work. Some may prefer the familiar Replay Remote Controller with an intuitive button layout and ultra-responsive jog wheel. Others love working with our touch-screen UI, with easy-to-access controls and great feeling scroll pad. And some operators want to work with both at the same time, which is why we offer both... so people can work exactly the way they want.

The RiMotion architecture also brings flexibility for remote, at-home productions. The system allows the backend hardware to be located on-site, while the UI can be extended via Internet to the production facility. This allows for a smaller footprint, less people needed on location and an unparalleled level of workflow flexibility.



Processing Units



Slomo Touch UI

SUPER-SLOMO CAPABLE

Features

R6

- » Compact 1RU Unit
- » Single Operator
- » Redundant PSU
- » 6 channel 1080p
- » Dedicated RCU
- » SSM optional license
- » Optional network features

R8

- » Compact 1RU Unit
- » Single Operator
- » Redundant PSU
- » 8 channel 1080p
- » Dedicated RCU
- » SSM optional license
- » Optional network features

R12

- » Compact 2RU Unit
- » Single or Dual Operator
- » Redundant PSU & RAID Storage
- » Large Recording Capacity
- » 12 channel 1080p
- » 2x dedicated RCUs
- » SSM optional license
- » Optional network features

R84

- » Compact 2RU Unit
- » Single or Dual Operator
- » Redundant PSU & RAID Storage
- » Large Recording Capacity
- » 8 channel 1080p HDR/4 channel UHD
- » Dedicated RCU
- » SSM optional licence
- » Optional network features

POWERFUL AND COMPACT SLOW MOTION SOLUTIONS

R6 / R8 / R12 / R84

RiMotion R6 and R8 are the perfect starting point for live replay, while the R12 takes your replay solution to another level with its dual operator support and the ability to network multiple servers to easily upscale your production. And with the new UHD bundle RiMotion R84, UHD productions can now profit from RiMotion's extensive feature set and ease of use, as the RiMotion R84 provides higher resolutions with 4 UHD channels and up to 8 1080p HDR channels.

R6/R8 offer 6/8 configurable channels for up to 4/6 camera inputs with a minimum hardware footprint in a 1 RU portable chassis and include:

- Replays & Highlights
- Import / Export of media
- Slow Motion Controller

R12 boasts 12 configurable channels for up to 10 camera inputs in a 2 RU portable chassis, while R84 introduces higher resolutions with 4 UHD channels. Both include:

- Replays & Highlights
- Import / Export of media
- Slow Motion Controller
- 4 Outputs for Dual Operators
- Networking of Multiple Servers

R6 Single Operator Workflow

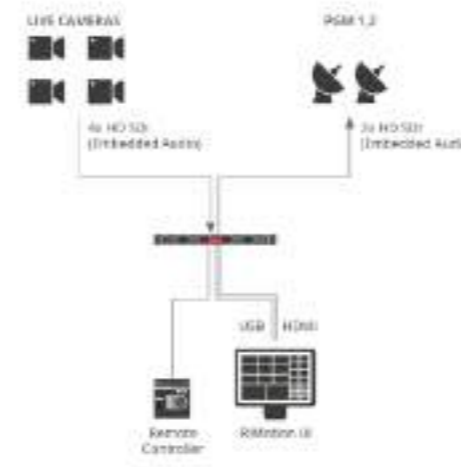

R8/R84 HD Configuration

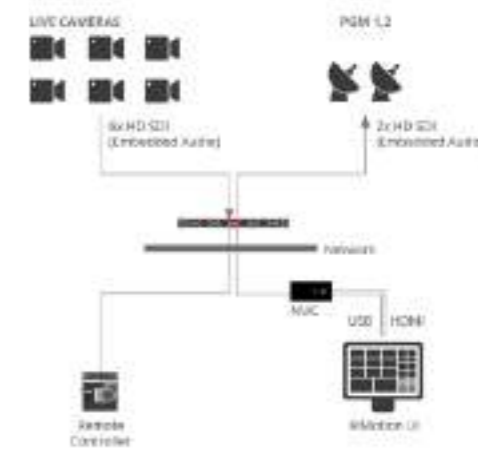

R84 UHD Configuration

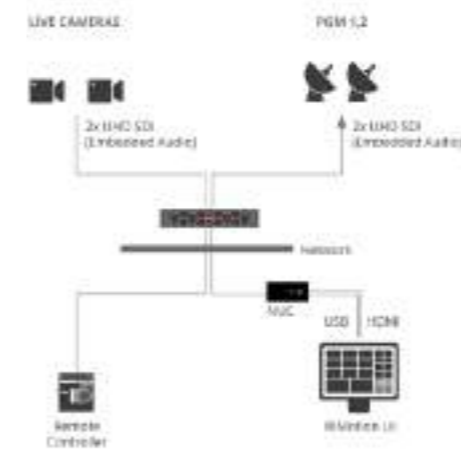

R12 Dual Operator Workflow

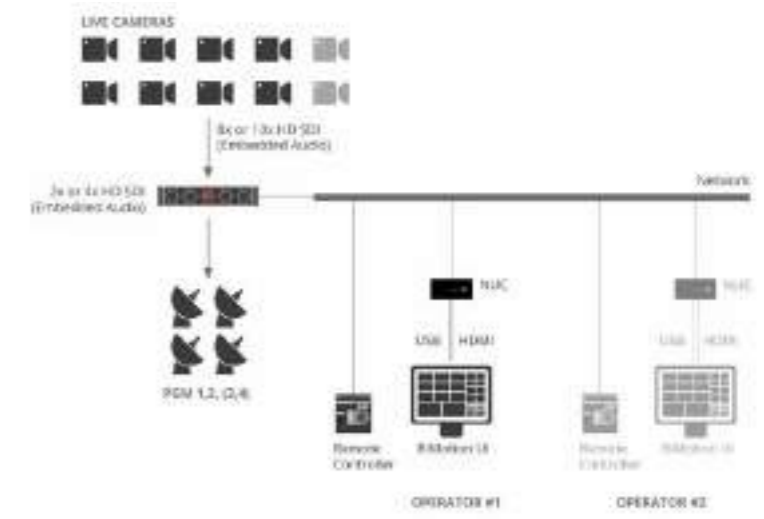

R6	R8	R12	R84	
VIDEO				
4x HD SDI Inputs	6x HD SDI Inputs	Up to 10x HD SDI Inputs	6x 3G SDI Inputs	2 x 12G SDI Inputs
2x HD SDI Outputs	2x HD SDI Outputs	Up to 4x HD SDI Outputs	2x 3G SDI Outputs	2 x 12G SDI Outputs
Additional I/O Options: NDI, TS UDP, TS RTP or SRT	Additional I/O Options: NDI, TS UDP, TS RTP or SRT	Additional I/O Options: NDI, TS UDP, TS RTP or SRT	Additional I/O Options: NDI, TS UDP, TS RTP or SRT	Additional I/O Options: NDI, TS UDP, TS RTP or SRT
Codec: DNxHD 120/145Mbps	Codec: DNxHD 120/145Mbps	Codec: DNxHD 120/145Mbps	DNxHR 120/145/ 185/220Mbps	DNxHR 920/1100Mbps
4in/2out Single User	6in/2out Single User	10in/2out Single User or 8in/4out Dual User	6in/2out Single User or 4 in / 4 out Dual User (option)	2in/2out Single User
VIDEO STANDARD				
HD 720p, 1080i and 1080p, 8-bit	HD 720p, 1080i and 1080p, 8-bit	HD 720p, 1080i and 1080p, 8-bit	720p, 1080i and 1080p, 10-bit	2160p
AUDIO				
Embedded audio: 16 tracks per video channel (input or output)	Embedded audio: 16 tracks per video channel (input or output)	Embedded audio: 16 tracks per video channel (input or output)	Embedded audio: 16 tracks per video channel (input or output)	
STORAGE				
2TB SSD storage (up to 24h)	2TB SSD storage (up to 24h)	5x2TB SSD Internal RAID Storage (up to 100h)	5x2TB SSD RAID storage (up to 100h)	
4TB or 8TB SSD (optional extension)	4TB or 8TB SSD (optional extension)	5x4TB SSD (optional extension)	5x4TB or 5x8TB SSD (optional extension)	
USB3 connectors for import from / export to external storage	USB3 connectors for import from / export to external storage	USB3 connectors for import from / export to external storage	USB3 connectors for import from / export to external storage	
UI MINI PC				
Not included	1x UI Mini PC included in the bundle	2x UI Mini PCs included in the bundle	1x UI Mini PC included in the bundle (2nd UI Mini PC optional)	
	Intel Core i7, 2.8GHz, 16GB RAM, 250G SSD	Intel Core i7, 2.8GHz, 16GB RAM, 250GB SSD	Intel Core i7, 2.8GHz, 16GB RAM, 250G SSD	
	110 / 230 V, 120W power supply	110 / 230 V, 120W power supply	110 / 230 V, 120W power supply	
NETWORK				
1x 1 Gigabit RJ 45 Ethernet port	1x 1 Gigabit RJ45 Ethernet port	2x 1 Gigabit RJ45 Ethernet ports	2x 1 Gigabit RJ45 Ethernet ports	
1x 10 Gigabit RJ45 Ethernet port	1x 10 Gigabit RJ45 Ethernet port	2x 10 Gigabit RJ45 Ethernet ports	2x 10 Gigabit RJ45 Ethernet ports	
CONTROLLER				
1x RCU included in the bundle	1x RCU included in the bundle	2x RCU included in the bundle	1x RCU included in the bundle	
Optional Touchscreen (not provided)	Optional Touchscreen (not provided)	Optional Touchscreen (not provided)	Optional Touchscreen (not provided)	
PROTOCOLS				
GPI control	GPI control	GPI control	GPI control	
TSL5	TSL5	TSL5	TSL5	
OPERATING SYSTEM				
Windows 10 Pro 64 bit	Windows 10 Pro 64 bit	Windows 10 Pro 64 bit	Windows 10 Pro 64 bit	
PHYSICAL				
1RU Chassis: HxWxD: 42.8 mm (1.68") x 482.0 mm (18.98") x 589.1 mm (23.19") with Bezel or 577.6 mm (22.74") without Bezel.	1RU Chassis: HxWxD: 42.8 mm (1.68") x 482.0 mm (18.98") x 589.1 mm (23.19") with Bezel or 577.6 mm (22.74") without Bezel.	2RU Chassis: HxWxD: 86.8mm (3.42") x 434.0mm (17.09") x 647.1mm (25.48")	2RU Chassis: HxWxD: 86.8mm (3.42") x 434.0mm (17.09") x 647.1mm (25.48")	
Weight: 8.74 kg (19.27lb)	Weight: 8.74 kg (19.27lb)	Weight: 27.3 kg (60.19lb)	Weight: 27.3 kg (60.19lb)	
POWER				
Redundant Dual 110/230 V, 550W PSUs	Redundant Dual 110/230 V, 550W PSUs	Redundant Dual 110/230 V, 1100W PSUs	Redundant Dual 110/230 V, 1000W PSUs	



RiCAPTURE

i4 / i4 Advanced

The New Networked UHD Master Recording Solution. i4 Compact, Powerful, High-quality Master Recorder.

The RiCapture i4 system offers a powerful UHD ingest recording solution built into a small form-factor with significant cost advantages.

Controlled with an easy-to-use interface for quick setup and deployment, i4 lets users record 1x UHD 12G-SDI input or 4x 3G-SDI inputs with 16 channels of embedded audio per video channel. Additional audio sources are available with 128 channels of Dante or 64 Channels of AES67. The i4 high quality recording offers DNxHD or DNxHR along with H264 4:2:0 and 4:2:2 encoding up to 40 Mbps. Its local i4 recording storage offers continuous loop recording for the captured content, with options to clip and export files as needed from the available local storage.

The application can connect up to 10 targets for streaming destinations. Users can easily select within each of these destinations whether to send only the high resolution DNxHD/R, the H264 – or both. i4 offers maximum versatility to capture the recorded media locally, on removable storage, on network attached storage or to live streaming destinations.

RiCapture i4 and i4 Advanced are the ideal solution for all your master recording needs – whether in an OB or live studio environment.

Features

- » Portable and Compact
- » Powerful, Professional Solution
- » Recording of up to 4x 3G-SDI inputs HD and 1x 12G-SDI input UHD
- » Up to 10 targets
- » Can record DNx & H.264 at the same time



i4 Touch UI & Hardware Units

i4	i4 Advanced
VIDEO	
4x HD SDI Inputs	4x HD SDI Inputs
1x UHD SDI Inputs	1x UHD SDI Inputs
Codec HD: DNxHD 8bits 120/145Mbps	Codec HD: DNxHD 8bits 120/145Mbps
Codec UHD: DNxHR 8bits 960/1160Mbps	Codec UHD: DNxHR 8bits 960/1160Mbps
VIDEO STANDARD	
HD 720p, 1080i and 1080p, 8-bit	HD 720p, 1080i and 1080p, 8-bit
4K UHD, 8-bit	4K UHD, 8-bit
AUDIO	
Embedded audio: 16 tracks per video channel	Embedded audio: 16 tracks per video channel
128Ch Dante or 64Ch AES67	128Ch Dante or 64Ch AES67
RECORD PROFILE	
Can record DNx and H.264 at the same time	Can record DNx and H.264 at the same time
H.264 4:2:2 encoding up to 40 Mbps	H.264 4:2:2 encoding up to 40 Mbps
Up to 10 targets	Up to 10 targets
STORAGE	
2TB SSD storage (up to 24h)	5 x 2TB SSD RAID storage (up to 100h)
NETWORK	
2 x 1 Gigabit RJ45 Ethernet ports	2 x 1 Gigabit + 2 x 10 Gigabit RJ45 Ethernet ports
OPERATING SYSTEM	
Microsoft Windows 10	Microsoft Windows 10
PHYSICAL	
Main unit: HxWxD: 110mm (4.33") x 380mm (14.96") x 300mm (11.81"), chassis, Weight: 7 kg (15 lb)	2RU Chassis: HxWxD: 86.8mm (3.42") x 434.0mm (17.09") x 647.1mm (25.48") Weight: 27.3 kg (60.19lb)
Rack-mount option	Rack-mount option
110/230 V, 1100W PSU	Redundant Dual 110/230 V, 1100W PSUs

VENUE GATEWAY

Standard / Advanced

Low Latency Remote Contribution Gateway

The Riedel Venue Gateway is a low-latency, bi-directional, multi-channel and multi-format contribution appliance bridging broadcast production infrastructures with distant venues. It aggregates and transports video signals, audio signals, commentary signals, intercom signals and tally.

Supporting many IP formats and SDI connectivity, the Venue Gateway offers great agility for contribution feed delivery. The web management interface has been designed to centralize and simplify the configuration. Featuring codec formats like H.264 and H.265, the gateway solution provides software defined low-latency encoding and decoding on 8 bi-directional channels with the highest broadcast quality.

The Venue Gateway offers seamless integration with direct IP sources being sent to the ViBox platform. It can also be integrated with any specialized transport security and redundancy solution such as Netinsight Nimbra Edge, Zixi Broadcaster or Techex MWedge.

Its built-in low latency multiviewer lets remote or on-site engineers view all sources in real time and test the network infrastructure with pre-loaded content.

The Venue Gateway is available as a standard or an advanced version, with the Venue Gateway Advanced adding two 10 Gigabit RJ45 Ethernet connectors for higher backbone bandwidths and two redundant PSUs in a compact 2RU frame.

Designed to provide flexibility and reliability to the users, the Venue Gateway is a complete solution that addresses all requirements of modern-day remote production.

Features

- » 8 Channel bi-directional encoder/decoder
- » for remote production contribution
- » Built-in low latency multiviewer offering
- » remote or on-site monitoring
- » Internal audio routing from encode to decode
- » sources with embedded, NDI®, AES67 or Dante®
- » Receives tally from remote production mixer for camera operators via TSL-5 or GPIO



Processing Units



Venue Gateway Web Interface

Venue Gateway

INTERFACE

8 x Bi-Directional 3G-SDI
2 x 1 Gigabit RJ45 Ethernet
1 x Genlock input
1 x LTC XLR

VIDEO CODEC

H.264 4:2:0 8 bits
H.264 4:2:2 10 bits
H.265 4:2:0 8 bits
JPEG XS (coming soon)

AUDIO CODEC

AAC
MPEG-1 Layer II

TRANSPORT FORMAT

SRT
Dante or AES67
NDI® (coming soon)
TS UDP (coming soon)
TS RTP (coming soon)

PATH PROTECTION

SRT (incl. redundancy)
RIST
ZIXI
2022-7 compliant (through 3rd party)

TALLY

GPIO
TSL5 over IP for Tally and UMD

COMMUNICATION - TALKBACK

Dante®, AES67 supported

LOCAL STORAGE

-

OPERATING SYSTEM

Windows 10 Pro 64 bit

PHYSICAL

HxWxD: 110mm (4") x 380mm (15") x 380mm (12")

7 kg (15 lbs)
10/230 V, 350W PSU

MONITORING

Integrated Multiviewer with video, audio, timecode and tally
Unrecovered packets, CC errors, RTP sequence errors, ETR290 (through 3rd party)

Venue Gateway Advanced

8 x Bi-Directional 3G-SDI
2 x 10 Gigabit, 2 x 1 Gigabit RJ45 Ethernet
1 x Genlock input
1 x LTC XLR

H.264 4:2:0 8 bits
H.264 4:2:2 10 bits
H.265 4:2:0 8 bits
JPEG XS (coming soon)

AAC
MPEG-1 Layer II

SRT
Dante or AES67
NDI® (coming soon)
TS UDP (coming soon)
TS RTP (coming soon)

SRT (incl. redundancy)

RIST

ZIXI

2022-7 compliant (through 3rd party)

GPIO

TSL5 over IP for Tally and UMD

Dante®, AES67 supported

2TB SSD

Windows 10 Pro 64 bit

2RU Chassis: HxWxD: 86.8mm (3.42") x 434.0mm (17.09") x 647.1mm (25.48")

27.3 kg (60.19lb)
Redundant Dual 110/230 V, 1100W PSUs

Integrated Multiviewer with video, audio, timecode and tally
Unrecovered packets, CC errors, RTP sequence errors, ETR290 (through 3rd party)



MEDIORNET
DISTRIBUTED
VIDEO
NETWORK

MEDIORNET

Distributed Video Infrastructures for Routing, Multiviewing & Processing

The broadcast media and entertainment industries find themselves in the midst of a massive and disruptive transition from SDI to IP technologies. Over the past decades, SDI has proven to be a reliable and practical standard for the distribution of video, audio and data signals – and it will continue to be an important building block in broadcast facilities and production in the next years. However, IP-based systems have emerged to form a powerful and flexible infrastructure that can accommodate the increasing demands for higher-resolution video and better connectivity.

With the introduction of MediorNet more than a decade ago, Riedel has pioneered the distributed approach to video infrastructures by combining signal transport, routing, processing, and conversion in a redundant real-time network. To this day, MediorNet remains the only system that offers all the advantages of distributed, software-defined hardware with an unprecedented level of security and reliability for both SDI and IP infrastructures.

Thanks to its great versatility and flexibility, the distributed system excels in event or sports venues, broadcast centers or outside broadcast fleets, and corporate or governmental facilities. That's why today there are millions of MediorNet SDI and IP I/Os deployed in different verticals all around the globe – from small installations to large and complex infrastructures.

If you are standing at the SDI-IP crossroads... MediorNet offers another way. Our growing MediorNet family keeps breaking down the barriers between the worlds of SDI and IP, offering a graceful and pragmatic hybrid path towards IP – at the right time and right cost.

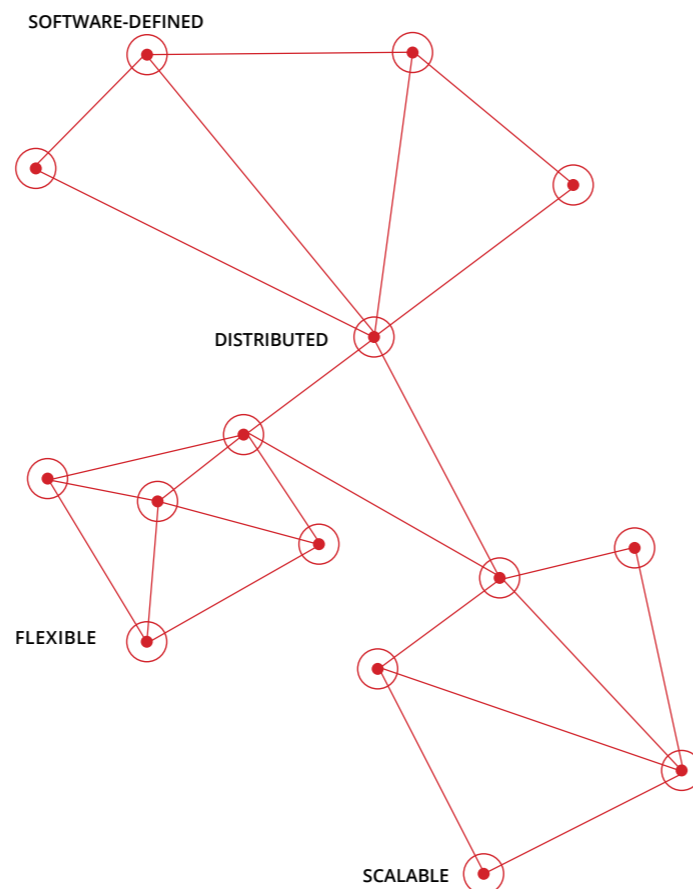

MediorNet's futureproof modular structure and innovative app concept enable it to adapt easily to changes in the market: As the industry's standards and expectations evolve, MediorNet evolves with them.

Riedel's most recent answer to the challenges arising from the IP transformation is the all-new hybrid SDI-IP processing platform MediorNet HorizoN. A complement to the intelligent SDI signal interfaces MicroN UHD, MicroN, Compact, and the MetroN core switch, this new node elegantly unites the SDI and IP worlds with its dense array of ST 2110 gateways, while providing powerful video processing capabilities.

At the very heart of the MediorNet IP world lies our patented MuoN SFP processor technology. MuoN SFPs are powerful, software-defined gateway and processing devices the size of a thumb that can be plugged into our MediorNet VirtU IP core platforms or COTS switches. The FusioN edge converters come in a similarly small form factor, offering standalone IP gateway or encode/decode functionalities just where you need them.

Within the ever-growing MediorNet family, you'll find all the tools you need for your production – whether it's SDI-centric, IP-centric, or anything in between. Riedel is just the right partner to guide you through this challenging time, providing you with a perfect transition path from SDI to full IP, at your own pace and within your budget constraints.

MediorNet – Features

- » One redundant architecture for video, audio, data & intercom
- » Real-time signal distribution, routing and processing
- » SDI/TDM, hybrid or full IP solutions
- » Video and audio processing: Up/down/cross conversion, color correction, HDR/SDR, JPEG-XS compression, embedding/de-embedding, frame sync/store and more
- » Multiviewer with fully flexible and static layouts including rich widget library
- » Supports any combination of network topologies
- » 3rd party router control
- » Software definable future-proof hardware platform

MediorNet – Key Benefits

- » Integration of various infrastructures into one network provides savings in cabling and infrastructure investments
- » MediorNet's flexibility and scalability allow versatile usage and quick adaption to new production needs
- » Integrated signal processing eliminates external glue hardware and again increases the installations flexibility
- » Expandable, software-based feature set makes MediorNet a secure long-term investment
- » Low power consumption

MediorNet Applications

SDI Solutions for Live Events

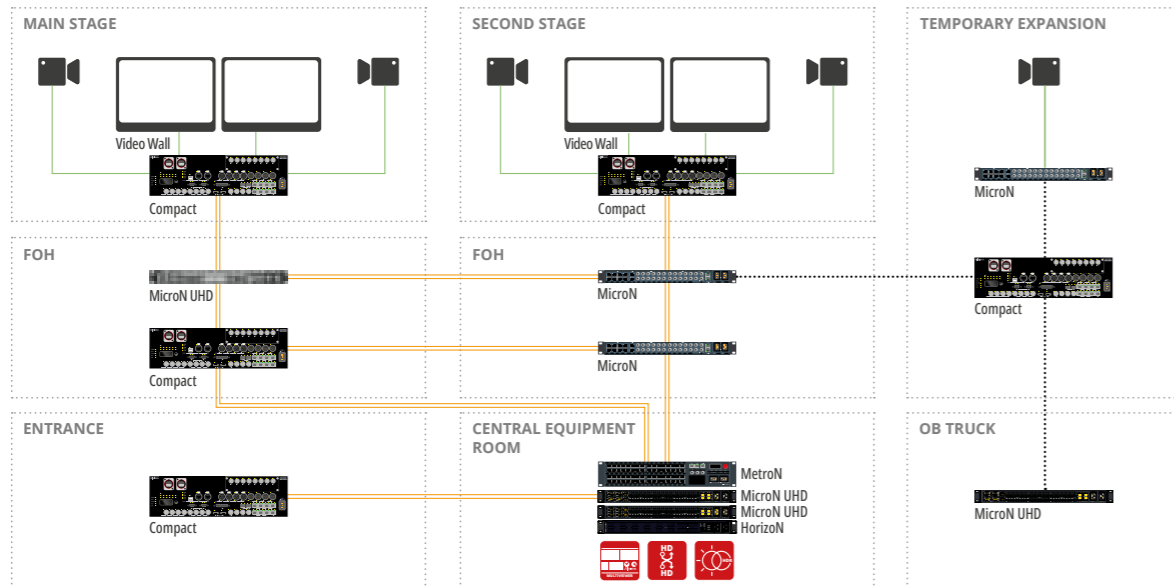

Riedel's robust MediorNet TDM devices are built for the rigors of live events. With its distributed, flexible topology and its innovative app concept, the system is highly adaptable to rapidly changing production needs. This is particularly useful in dynamic environments like festivals, where MediorNet allows to add more devices and apps on the fly and with minimal effort. Need additional video capacity at side stage 2? Just add a MicroN or Compact Pro node, connect it to the network and off you go!

In any live event scenario, MediorNet shines as a legitimate plug & play solution with very short setup times, fast and intuitive configuration, as well as integrated processing and multiviewing capabilities. And whenever you need even more processing

power, MediorNet Horizon with its UDX/SDR-HDR conversion or color correction is available just where it is needed. As an all-round event backbone, MediorNet incorporates various infrastructures in one network and provides an ethernet tunnel for systems including CCTV, internet access, weather monitoring, cashless payment, lighting control and of course intercom.

Not only suitable for large festivals, MediorNet offers a host of advantages to smaller events and venues. These benefit from devices like MediorNet Compact Pro, MicroN and Horizon providing integrated signal processing at the cost of simple multiplexing point-to-point products.

IP & Hybrid Solutions for TV Studios

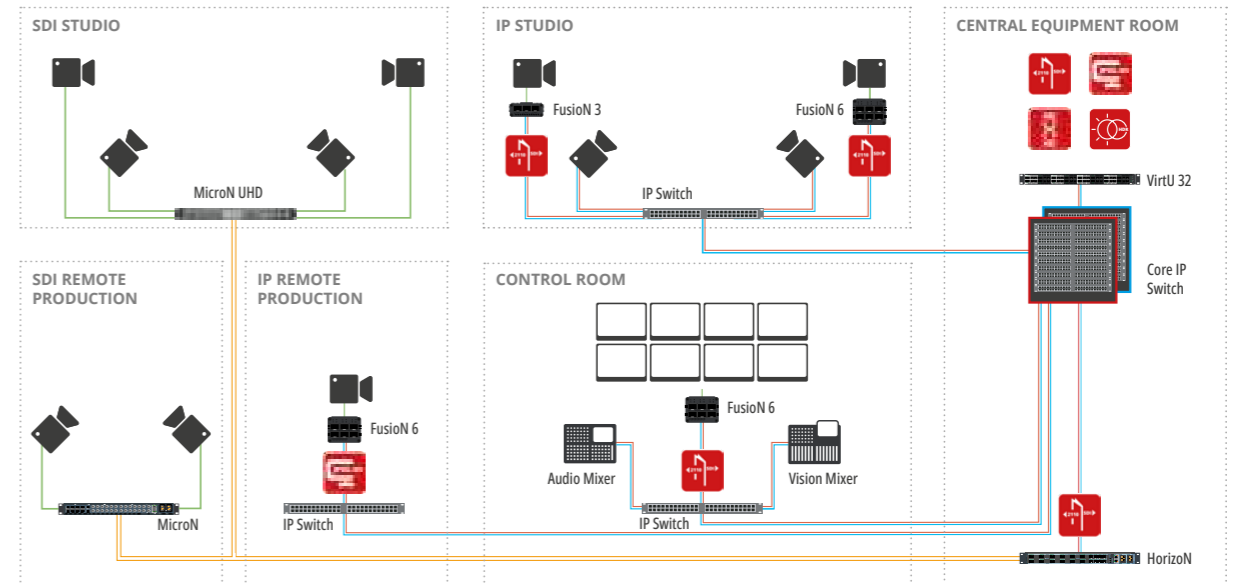

Planning to go full IP in your TV studios? Or are you looking to make a first step towards IP but don't want to abandon all your trusted SDI equipment? Our flexible systems allow for hybrid solutions that combine the best of both worlds and support a smooth, incremental transition to IP workflows. The MediorNet IP bridge creates high-speed IP pipes between your SDI infrastructure and your IP network, while the MediorNet IP MuoN and Horizon allow you to gradually grow your IP-based routing, and processing capabilities.

Boasting 64 (UHD) gateway and processing channels per rack unit, MediorNet VirtU provides the highest density and power efficiency on the market. The FusioN standalone converters complement the solution by converting signals at the edge, significantly reducing cabling and space requirements. To easily connect SDI infrastructure islands to your IP system, MediorNet

Horizon integrates core processing, routing, and SDI-IP conversion capabilities in a single RU, creating interconnectivity between all products and sites of any signal types.

Besides their open, standards-based and proven interoperability, all MediorNet products easily integrate with Ember+/ NMOS-based orchestration and control. Their flexible and scalable distributed architecture lets you swiftly add not just single devices but entire subsystems like backup glue.

So the options are varied and versatile. Thanks to its great versatility and flexibility, the distributed system excels in live events, sports venues, broadcast centers, outside broadcast fleets, corporations and governmental facilities.

Distributed Routing

MediorNet provides versatile distributed routing and gateway capacities for any SDI, IP, or hybrid production environment. Instead of a central router, MediorNet infrastructures are based on an array of decentralized network devices and intelligent nodes. This distributed system intelligence allows the free placement of physical I/Os, which increases the flexibility of any installation while significantly reducing cabling and set-up time. With MediorNet, you get one unified SDI or IP backbone for all your signals. Because MediorNet is not just about video... even audio, intercom, serial data or ethernet can be transported and routed effortlessly to and from any conceivable point.

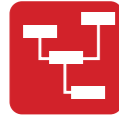

MicroN UHD & MicroN Standard App

The Standard App provides high-density signal interfaces into the distributed MediorNet TDM ecosystem and allows to build highly scalable audio and video routing solutions. It enables 24/48 SDI video signal port (up to 12G SDI) and 2 MADI audio interfaces and provides 80G/400G backbone connectivity. All audio and video ports come with standard processing features like frame synchronizers, embedders/de-embedders and many more...



MuoN Audio Routing App

Allowing to re-route and re-format IP audio flows, the MuoN Audio Routing App enables management of different IP audio stream schemes and mappings. It comes with an internal 2048x2048 audio router to send and receive up to 64x ST 2110-30/-31 audio flows with up to 32 audio channels each.



HorizoN, MuoN & FusioN

Encapsulation/Decapsulation Apps

Offering the highest density on the market, these Apps provide highly scalable and flexible audio and video gateways into distributed IP networks. The broad selection of conversion applications enables conversion of various baseband signals to ST 2110 and vice versa. The HorizoN, MuoN & FusioN video gateway applications come with full UHD support and frame synchronizers. The MuoN A also offer SDI from/to ST2022-6 conversion.

Distributed Signal Processing

Basic signal processing is integrated across all MediorNet gateway devices. These processing functions allow for seamless routing across the decentralized MediorNet network and across different formats. With a wide selection of apps, enhanced processing capabilities like up/down/cross conversion, color correction, or encoding/decoding, can be added to the system just where they are needed. As MediorNet solutions are software- defined and FPGA-based, you buy not only what the product is capable of today, but also what it will be capable of in the future.



MediorNet TDM Integrated Processing

With integrated processing features such as frame store/frame sync, embedders/de-embedders, test pattern generators and sample rate converters, MediorNet minimizes the need for external processing and glue equipment. Through these features, the system provides enormous efficiency gains in all production environments.



MuoN & FusioN Encode/Decode Apps

The Encode/Decode Apps for MuoN and FusioN handle conversion to or from IP ST 2110 with JPEG-XS encoding and decoding, with FusioN also providing SDI for your inputs and outputs. When used with MediorNet VirtU devices, they boast the highest density in the market with 64 encode/ decode channels within a single RU.



HorizoN & MuoN Up/Down/Cross Conversion Apps

These converter apps enable high-quality conversion to/from any UHD/3G/HD content. They can be used for incoming feed signal normalization or to provide down-converted HD versions of UHD signals for easy monitoring inside the facility. The MediorNet UDX converters provide pristine image quality scaling and de-interlacing motion adaption and directional interpolation. This App also includes color space conversion between BT.709 and BT.2020 as well as a full color converter.



HorizoN & MuoN HDR Conversion App

The HDR App provides compatibility between the multiple SDR or HDR signal formats inside a live production environment. The conversion happens in real time using 3D LUT (Look-up-table) color transformation files. The product comes with preloaded files from BBC and NBC, but users can add their own 17, 33 or 65 resolution cube files.



Up/Down/Cross Conversion

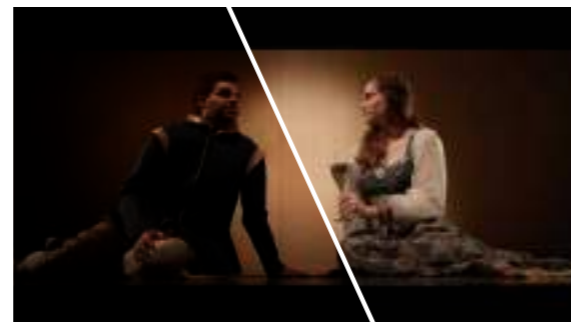

Color correction (for RGB and YCbCr)

Distributed Multiviewing

Multiviewing remains one of the most important processing and monitoring features in any video system – and distributing multiviewer capacities may considerably streamline all associated processes and workflows. For one, the integration into a distributed MediorNet ecosystem enables efficient monitoring of any signal and flexible routing of multiviewer heads to any physical output. For another, the various MultiViewer Apps available for MicroN UHD and MicroN provide unmatched scalability, flexibility and density, as well as support for 3rd party interfaces like Ember+, NMOS, and TSL, making them just the right choice for any production.



MicroN UHD & MicroN MultiViewer Apps

With access to all distributed MediorNet signals, the MicroN UHD & MicroN MultiViewer Apps make these available on one of up to eight monitoring heads that can be routed to any given output. Both apps feature a rich set of widgets, as well as fully flexible scaling and positioning of elements on the screen. As MediorNet is distributed by nature, the MultiViewer Apps allow to use system-wide clocks, time codes and counters and easy configuration sharing. The MicroN UHD Multiviewer App includes all the powerful features of the MicroN Multiviewer App, while increasing the input channel amount to 36 PiPs.



MediorNet TDM MultiViewer

Remote and Distributed I/O

There are ever-larger distances to be covered between the various parts of modern production chains, e.g. between venue and production truck, between buildings on a campus, or between facilities in different parts of the city. The MediorNet family is fully suited to all those needs: For IP networks, it features JPEG-XS encode/decode solutions and the compact FusioN devices, which can be installed right at the signal sources and destinations to transfer the signals directly. And for both SDI and IP environments, there are powerful and efficient stagebox solutions to be implemented with MediorNet Compact or FusioN, or the MicroN Point-to-Point App.



MicroN Point-to-Point App

The MicroN Point-to-Point App enables all hardware ports on the device, but limits network size to two devices in one net, making it a cost-efficient solution to connect two devices located in your main production site and your remote facility. The app also enables the hardware to operate standalone: This way, a single MicroN can act as a 12x12 router and audio embedder/de-embedder with MADI and sync delay, while also providing video frame sync and delay.



Compact Standard App

MediorNet Compact is a fiber-based stagebox providing enough capacity for bi-directional transport of 16 HD-SDI signals, dozens of MADI streams or GBit-Ethernet signals and hundreds of audio channels or intercom ports – ideal for streamlining the infrastructure of any mobile, studio or live event application.



MuoN & FusioN Encode/Decode Apps

Signal compression is a key enabler to exchange feeds between remote sites through low bandwidth connectivity. The JPEG-XS Encode/Decode App can be installed on MuoN SFPs or FusioN devices to provide an extremely dense and cost-effective solution. In addition to providing SDI I/Os with encode or decode signals into JPEG-XS, the I/Os are also available as ST 2110. This solution is perfect for internal television station monitoring systems, signal contribution or remote production applications.

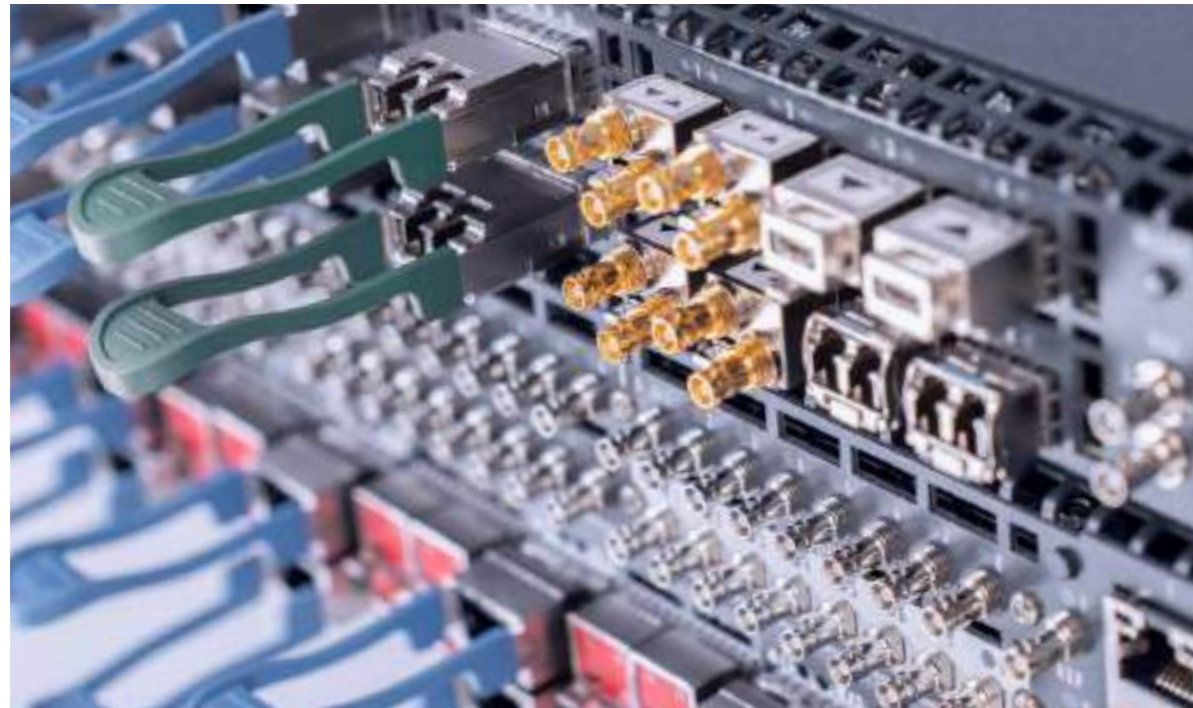

Meet the MediorNet Family

HorizoN



MediorNet HorizoN blurs the boundary between traditional SDI-based and ST 2110 infrastructures with its dense array of SDI-IP gateways and offers an incredible amount of video processing capabilities such as up/down/cross, SDR-HDR conversion and color correction. Within a single rack unit, 16 independent and individually configurable processing engines allow up to 128 channels of SDI-ST 2110, up to 32 channels of SDR-HDR or up to 16 up down/cross conversions. SFP-based baseband video I/O completes the package, making it an extremely versatile solution that can handle even the toughest challenges in a modern production environment.



Features

- » Up to 16x processing engines, e.g. for UDX, SDR/HDR conversion, Color Correction and ST 2110 IP Gateways
- » 4x 100G highspeed links
- » 4x 100G IP Interfaces (2022-7)
- » 8x 3G/HD/SD-SDI In & 8x 3G/HD/SD-SDI Out
- » Sync reference In / Out (BB, Tri-Level, WC)
- » Integrated processing incl. sample rate conversion, frame sync, test pattern generator

MicroN UHD



MediorNet MicroN UHD adds more bandwidth, more I/O, higher resolutions, and more processing power to the MediorNet platform. The device provides 400G backbone connectivity for signal distribution over meshed architectures, includes 12G-SDI for native UHD (4k) workflows, and allows reliable operation due to link redundancy.



Features

- » 4x 100G highspeed links
- » 8x 12G/3G/HD/SD – SDI In1 & 8x 12G/3G/HD/SD SDI Out2
- » 8x 3G/HD/SD-SDI In & 8x 3G/HD/SD-SDI Out
- » 16x 3G/HD/SD-SDI In / Out (switchable)
- » 2x SFP ports (for MADI)
- » Sync reference In / Out (BB, Tri-Level, WC)
- » Integrated processing incl. sample rate conversion, frame sync, test pattern generator and more

MicroN



MediorNet MicroN is software-enabled, app-based hardware that can either be a simple point-to-point link for up to 12 bi-directional 3G signals, or part of a large de-centralized router – but it can even serve as a distributed MultiViewer and provides a lot of glue functionality like frame synchronizers, test pattern generator, embedding, de-embedding and more.



Features

- » Seamless integration into MediorNet TDM family
- » 8x 10G Highspeed links
- » 12x 3G/HD/SD-SDI In & 12x 3G/HD/SD-SDI Out
- » 2x SFP ports (for MADI)
- » Sync reference In / Out (BB, Tri-Level, WC)
- » Software-defined hardware: 5 Apps available
- » Powerful integrated processing functions including sample rate conversion, frame synchronizers, test pattern generator and more

MetroN



The MediorNet MetroN core router provides intense real-time signal-routing capacity (32x10G/32x4.25G ports) and offers non-blocking switching. The 2-RU device features switching delays of <40ms as well as high-speed re-routing that allows as many as 1,000 connections to be re-routed in less than a second.



Features

- » 64 auto-sensing ports (32x 10G / 32x 4.25G)
- » 2 ethernet ports plus 1 config port
- » 1 sync In / 2 sync Out
- » Redundant power supplies and fan modules



Compact



MediorNet Compact is the cost-effective and easy-to-use entry to the world of MediorNet. With a network bandwidth of 50 Gbit/s, MediorNet Compact provides enough capacity for bi-directional transport of 16 HD-SDI signal, dozens of MADI streams or GBit-Ethernet signals and hundreds of audio channels or intercom ports.



Features

- » Wide array of I/Os, capacity for 16 HD-SDI signals, dozens of MADI streams or GBit- Ethernet signals and hundreds of audio channels or intercom ports
- » Powerful integrated processing functions including sample rate conversion, frame synchronizers, test pattern generator and more

MuoN

MuoN A10



MuoN B10



MuoN B25



MuoN SFPs are pluggable gateway and processing devices that can be used inside the VirtU-32 passive housing frame (MuoN B series) or inside VirtU-48-S top-of-rack switch (MuoN A series). The software-defined hardware is available with a range of different input and output configurations, including BNC, fiber, or HDMI (1.4 and 2.0). MuoN SFPs can be configured with a wide range of different apps: A simple change of the software license turns the device into an up/down/cross or HDR converter, JPEG-XS encoder or decoder, an audio router, or even a 16x1 multiviewer.

Features

- » Software-defined platform with up to 3 app spaces per MuoN SFP
- » Available with different I/O port configs or as an IP-to-IP SFP without external connectors
- » Powerful processing apps, including Gateway, UDX, HDR Conversion, or Encode/Decode Apps with optional Frame Sync and Clean Switching Add-Ons
- » Extremely compact, low weight, low power consumption
- » Field upgradable

FusioN

FusioN 3



FusioN 6



The FusioN series of compact standalone I/O and processing devices can be configured with a range of software apps to act as IP gateway or encoders/decoders. Due to their small form factor and low power consumption, the devices can be placed close to signal sources or destinations, creating powerful efficiencies in any production environment.

Features

- » Miniature processing frame with 3 or 6 SFP slots supporting 2x fiber links for ST2022-7 hitless redundancy
- » Flexible I/O configuration with support of SDI, HDMI and fiber through SFP plug-in modules
- » Auto-sensing for HD and UHD formats
- » Mountable to the back of a standard monitor or installed into 2RU bracket housing up to 9/18 frames
- » Powerful processing apps, including Gateway, or Encode/Decode Apps with optional UHD, Frame Sync, and Clean Switching Add-Ons

VirtU

VirtU 32

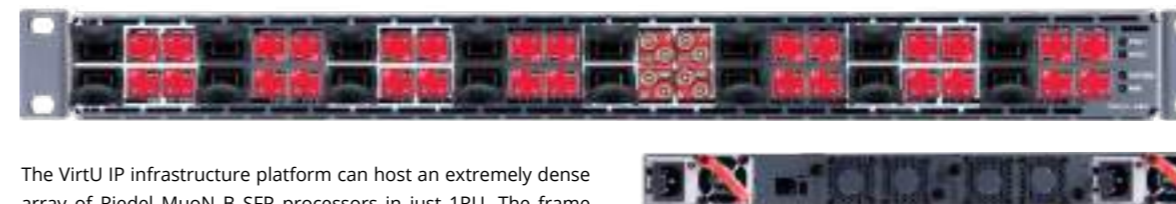

The VirtU IP infrastructure platform can host an extremely dense array of Riedel MuoN B SFP processors in just 1RU. The frame can be used as a bulk gateway, as a very dense processing unit or for any combination of gateway and processing. This modular platform allows users to gradually build their key advanced gateway and processing power as their needs grow!

Features

- » 8 independent clusters of 4x MuoN B SFPs connecting to a dual set of 40G/100G uplinks for ST2022-7 hitless redundancy
- » Allows any mix of MuoN B SFPs (per cluster host data rate must be the same)
- » Very high reliability: fully passive signal path from QSFPs to SFPs, redundant power supply

MediorNet Specifications Overview

Features	MediorNet Horizon	MediorNet MicroN UHD	MediorNet MicroN
MediorNet TDM Links	400G (16x 25G)	400G (16x 25G)	80G (8x 10G)
SDI Video I/O	8x in (up to 12G) 8x out (up to 12G)	16x in (up to 8x 12G), 16x I/O switchable, 16x out (up to 8x 12G)	16x in (up to 3G), 12x out (up to 3G)
Video Sync	1x I/O switchable, 1x out	1x I/O switchable, 1x out	1x I/O switchable, 1x out
MADI	-	2x 64ch (optical or electrical)	2x 64ch (optical or electrical)
Ethernet Tunnel	-	3x 1000/100/10 Mbit/s	1x 1000/100/10 Mbit/s
Integrated MediorNet Processing	Available on all video ports	Available on all video ports	Available on all video ports
MediorNet Apps	Standard App (UDX, HDR, ST 2110 IP Gateway)	Standard App, MultiViewer App	Standard App, MultiViewer App, Processing App, Point to Point App
Additional Connectivity	Up to 16x 25 GE ST 2110 IP Interfaces (ST2022-7)	-	-
Redundant Power Supply	2x Wide Range AC PSU	2x Wide Range AC PSU	2x Wide Range AC PSU
Power Consumption	350w	200 W	50 W
Weight	10 kg	6.9 kg	5.1 kg
Dimensions	478mm (19") x 44 mm (1RU) x 500 mm	482 mm (19") x 44 mm (1RU) x 330 mm	483 mm (19") x 44 mm (1 RU) x 241 mm

Features	MediorNet MetroN	MediorNet Compact
MediorNet TDM Links	50G (12x 4,25G)	320G (32x 10G or 64x 4,25G)
SDI Video I/O	4x in (up to 3G), 4x out (up to 3G), up to 8 optional I/O	-
Video Sync	1x in, 3x out	1x in, 2x out
MADI	2x 64ch (optical or electrical)	-
Ethernet Tunnel	3x 1000/100/10 Mbit/s	2x 1000/100/10 Mbit/s
Integrated MediorNet Processing	Available on all video ports	-
MediorNet Apps	-	-
Additional Connectivity	Display Ports, Analog Audio, AES Audio, Serial Interface, GPI Ports	-
Redundant Power Supply	Wide Range AC PSU, 12V DC Input	2x Wide Range AC PSU
Power Consumption	80 W	175 W
Weight	8.2 kg	12.5 kg
Dimensions	483 mm (19") x 133 mm (3 RU) x 241 mm	483 mm (19") x 88 mm (2RU) x 425 mm

Features	MediorNet MuoN A	MediorNet MuoN B	MediorNet FusioN 3B	MediorNet FusioN 6B
APP types	ST2022-6 and ST2110 - SDI Gateways	ST2110-SDI Gateways, HDR/SDR, UDC conversion, JPEG-XS Encode/Decode and MultiViewer	ST2110-SDI Gateways, JPEG-XS Encode/Decode and MultiViewer	ST2110-SDI Gateways, JPEG-XS Encode/Decode and MultiViewer
I/O types	SDI (2T, 2R), and (HDMI 1T)	SDI (2T, 2R, RT) and IP to IP (PP)	SDI (2T, 2R, RT), Fiber (2T, 2R, RT), HDMI (1T, 1R)	SDI (2T, 2R, RT), Fiber (2T, 2R, RT), HDMI (1T, 1R)
Formats	HD and 3G	HD, 3G and UHD	HD, 3G and UHD	HD, 3G and UHD
Media Networks	1x 10GE with support of ST2022-7	2x 10GE or 25GE depends on APP selection	2x 10GE or 25GE depends on APP selection	2x 10GE or 25GE depends on APP selection
Management and control	in-band	in-band	in-band	in-band
Housing frame	VirtU-48-S , FusioN 3A	VirtU-32	Standalone frame or installed inside MBR-18-B-F	Standalone frame or installed inside MBR-18-B-F
Redundant PSU	NA	NA	Optional	Optional
Power Consumption (depends on selected APP)	2w	5-8w	7-14w	7-18w
Noise level	0dBA	0dBA	27.4dBA	42dBA
Weight	.02kg	.02kg	.068kg	.055kg
Dimensions	L: 5.5, W: 1.3, H: 1.3 cm	L: 5.5, W: 1.3, H: 1.3 cm	L: 10.7, W: 5.7, H: 2.3 cm	L: 12, W: 5.7, H: 5.2 cm

Features	MediorNet VirtU-48-S	MediorNet VirtU-32
Housing capacity	48x MuoN A SFPs	32x MuoN B SFPs
Media Networks	48x 1/10/25GE ports + 8x 40/100GE ports	32x 10/25GE ports + 16x 40/100GE ports
Management and control	out-of-band	out-of-band
Redundant PSU	Yes	Optional
Power Consumption	362w max	510w max
Noise level	71.6dBA	70dBA
Weight	8.52kg	4.54kg
Dimensions	L: 43.6, W: 43.8, H: 4.3 cm	L:20.3 , W: 44.8, H: 4.3 cm

RILINK
GLOBAL
NETWORK
SERVICES



RILINK – IP MEDIA WAN

The Solution to Globally Connect Venues and Studios

RiLink is our IP-based solution for transferring broadcast signals such as audio and video feeds with a maximum of flexibility providing a channel for each individual media signal as well as for voice and other data communication in parallel. RiLink has some key advantages compared to satellite links since traffic can be sent bidirectionally during the entire event period

rather than only during dedicated time slots in case of a satellite connection. In addition, the Riedel RiLink solution based on our own network infrastructure provides a much more cost efficient service with business class quality and reliability. The result is an integrated, all-round service package that can be customized to your specific requirements.

Features:

Bi-directional:

RiLink connections are always bi-directional, allowing clients to send and receive feeds, access digital archives, or achieve full-duplex communication all in parallel, resulting in a high level of flexibility.

Multi-VPN:

For complex network architectures, several logically separated VPNs can be implemented. This enables a flexible segregation of signals, services or user groups on one physical connection. Thus, any number of bi-directional Audio/Video channels can be handled based on different VLANs..

Latency:

RiLink's latency is provides high quality data connectivity with short data run time as known from fixed networks. This signal propagation time is significantly shorter than any satellite link and signals exhibit significantly less jitter. Within Europe, for instance, signal runtime on the Riedel Network is in the order of 20 milliseconds, whereas a satellite link exceeds 300 milliseconds by far.

Flat-rate billing:

In contrast to satellite links, RiLink is charged at a flat rate for the duration of the event or term. This allows for more precise budgeting and further live, pre-, or post-event processing will never incur extra costs.

High quality:

RiLink provides guaranteed, dedicated bandwidth which is available during the entire event period. However, by implementing priorities for certain services, the available bandwidth can be optimized. Since the connectivity on the MPLS network is any-to-any, IP packets are always taking the most direct path to their target destination, ensuring efficient use of the available bandwidth.

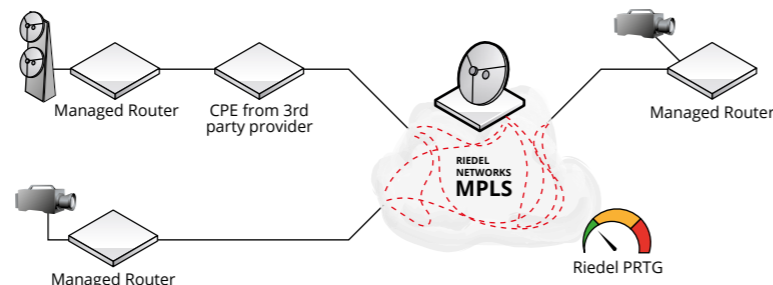

Versatile:

RiLink generates synergies between various communications services including broadcast signals, audio/video feeds, voice communication (intercom/VoIP), data transfer (CRM/SAP) and Internet access.

Reliable:

The Riedel Networks MPLS Backbone is based on a highly redundant network architecture to ensure a high level of availability. For local access to sites or events, RiLink can accommodate different levels of redundancy. The assured availability on Riedel's MPLS core network is 99.999%. For local customer locations, the availability varies between 99 and 99.6% depending on the physical infrastructure and any selected backup options.

Performance Monitoring & proactive trouble shooting:

Riedel operates a Performance Monitoring tool that clients can access to monitor relevant indicators like availability, capacity utilization, jitter and signal run time. Each connection can be monitored via Web Browser or Smartphone App for iOS and Android. In case of any issue, the Riedel Networks 24/7 NOC is located near Frankfurt and available to assist. Trouble-shooting is automatically, proactively initiated without customer input to ensure the fastest possible solutions.

RILINK – DIRECT INTERNET ACCESS

The Business Class Internet Access for your Event

RiLink Direct Internet Access is a business class connection to the public Internet with guaranteed bandwidth and Quality. The service is available in several flavors, as a transparent service, with a managed router, via the Riedel MPLS network and protected including a Firewall blocking all unwished data streams. The Direct Internet Access service delivers a reliable Internet connection that can be customized to your specific requirements.

Features:

Direct Internet Access - only:

Internet Access without active Network Monitoring and Troubleshooting via DSL, fibre, Ethernet or LTE.

Direct Internet Access - plus:

in addition a managed router provided by Riedel Networks with active Network Monitoring.

Direct Internet Access - transparent:

Internet Access via the Riedel MPLS network directly to one of the Internet peering points, fully managed and monitored by the Riedel NOC team.

Direct Internet Access - protected:

In addition to the RiLink – Direct Internet Access transparent service, all data traffic, in coming and outgoing, is routed via a Firewall to block all fraudulent and blacklisted traffic streams.

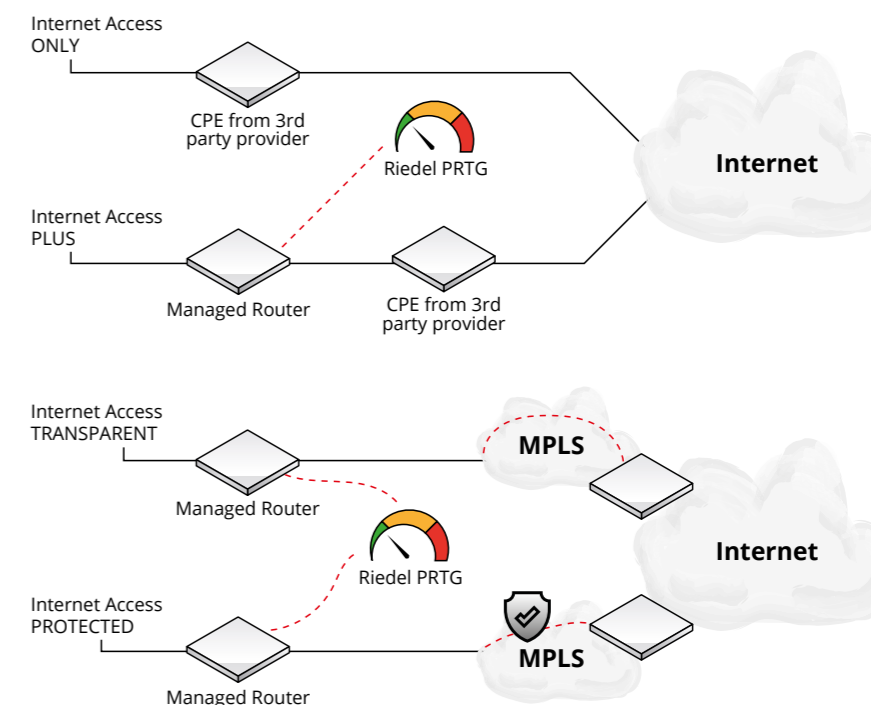

Riedel's Global Fiber Network

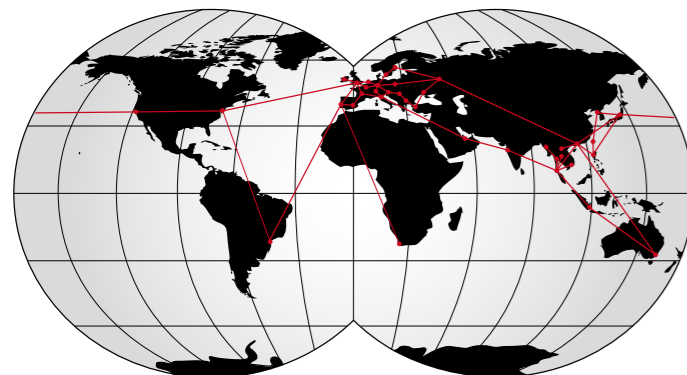

How does RiLink work?

Riedel's global network service is based on a dedicated, global MPLS backbone, owned and operated by Riedel Networks GmbH & Co. KG. The network has a meshed structure and provides the foundation for global Multi Protocol Label Switching (MPLS) based connectivity, providing maximum reliability and minimum latency. Unlike solutions realized using the Internet, the Riedel global network service provides a secure and fully transparent end-to-end solution with dedicated connections and guaranteed bandwidth, quality and availability.

QoS mechanisms throughout the entire backbone meet maximum requirements with regards to transmission quality (latency, bit error rate, jitter), reliability (guaranteed bandwidth, redundancy), security, availability and delivery time.

RiLink References (selected)

Moving event locations

- **ESC 2019 Tel Aviv**, provision of several redundant Internet links, telephone services and DDoS attack prevention.
- **Nations' Village @ Olympic Winter Games Pyeong Chang 2018**, delivery of a high bandwidth and performant Internet Access.
- **Live Nation @ Wireless Festival Germany 2019**, high bandwidth and performant Internet Access for complementing services e.g. Intercom, VoIP, WLAN and CCTV.
- **VideoART @ 5-Continent-Congress Barcelona 2018**, live transmission between conference centre and clinic location over a Layer 2 EVPL connection.
- **BMC UK @ football match England vs. Lithuania 2017**, transport of A/V feeds over Layer 2 EVPL connection between Lithuania to England
- **RTL @ F1**, transmission of live HD 1080i signal on H.264 from every race track to Cologne broadcast station with embedded audio channels plus data service, including off-peak usage in case of no video signal transmission
- **NOS @ Olympic Winter Games 2014 in Sochi**, transmission of 2x live HD 1080i signals on H.264 from Sochi MCR to Hilversum broadcast station with 16x audio channels embedded plus 400M data service for file transfers
- **ESPN @ X-Games Tignes 2013**, transmission of three primary live feeds (world feeds, english, non-english and non-sponsor) and two additional camera feeds for the on-site studio show from Tignes (in the Alps) in France to ESPN IBC in Bristol plus data service in parallel

Long term contracts

- **WDR @ Cologne**, connecting the WDR foreign offices in Warsaw, Moscow, Brussels, New York, Washington and Paris to the Cologne headquarter for transfer of live and preproduced content.
- **RTL @ NewYork**, connecting their US foreign office of RTL group to Cologne broadcast station via Ethernet for live HD 1080i signal transmission and for file transfer during off-peak usage
- **Toyota Gazoo Racing (TGR)**, Seamless remote communication between all global teams and any of the racetracks (e.g. FIA World Endurance Challenge) following the strict security guidelines of the Toyota Motor Corporation.
- **Scuderia AlphaTauri**, Private cloud network connecting pit crews to the so-called "remote garage" in their factories across Europe and Sakura, Japan enabling fast decisions and pit stop strategies on the racetrack.

How to get a quote for your application

Please contact your Riedel sales manager or send the following information to rmlink@riedel.net:

- » Addresses of the locations
- » Starting time and duration of the event
- » Quantities & formats of video signals
- » Compressed or native signal transport
- » Quantities & formats of audio signals
- » Quantities & formats of intercom signals
- » Desired bandwidth and type of IP services



Customer: House of Switzerland, P&G and others
 Project: Nations Village Winter Games 2018 in Pyeongchang
 Task: Internet and MPLS for media representatives and broadcasters



Customer: ITR
 Project: DTM
 Task: MPLS and public internet for up to 60 live streams on major social media platforms and private video streams to teams and organizer



Customer: EBU
 Project: Eurovision Song Contest Tel Aviv 2019
 Task: Provision of redundant internet links, telephone services, VoIP, USOC and cybersecurity



Customer: RTL (Germany)
 Project: Formula One Season (since 2011)
 Task: Transmission of live broadcast signals from the racetrack, provision of archive access & intercom connectivity to main facility in Cologne (Germany)

ARTIST
DIGITAL
MATRIX
INTERCOM



ARTIST Ecosystem The Advanced Communications Platform

Artist is a decentralized, scalable digital intercom network that provides reliable communications and audio signal distribution for any audio or intercom application.

An Artist system can be anything from a single Artist frame to a vast, fiber-based and remotely connected network of interconnected nodes. Each modular node contains client cards that accept and distribute different types of signals including SMPTE 2110-30/31 (AES67), VoIP, DANTE, AVB, MADI, AES3 and analogue audio. At the present time, Artist is the only intercom platform that talks all audio standards – and its modular architecture allows for the easy accommodation of future standards.

Artist easily scales to fit any application from small theatres to OB vans to multi-national broadcast centers and global events. The non-blocking Artist system can be expanded from 8x8 to 1024x1024 ports and, via inter-node trunking, can connect several thousand subscribers within a single ecosystem. Scaling an Artist system is as easy as adding new client cards to an existing node or adding additional nodes (Artist-32, Artist-64, Artist-128, Artist-1024). This flexibility and modularity make Artist solutions futureproof and enable the system to scale to the demands of any project.

Artist infrastructures natively allow for a high degree of decentralization and the flexible placement of nodes, considerably reducing the wiring and setup costs for any installation. The decentralized network structure also enhances the system's reliability as its dual ring fiber optic network topology provides full redundancy. On top of that, all internal modules within the Artist frames are hot-swappable, the frames themselves have dual power supplies, and the system configuration is stored within each node.

But a comms platform is not just about the nodes. The user experience of any intercom system is defined by its control panels – and Artist is the only intercom system to employ the SmartPanel concept of app-driven user interfaces. Riedel's SmartPanels provide multiple connectivity options, allow for software-definable workflows, and combine a vast range of features into a single user interface. Plus, only Artist seamlessly integrates with the award-winning Bolero wireless intercom system to provide flexible and reliable wireless communications to complement the wired intercom panels.

ARTIST – Key Benefits

- » Decentralized, masterless architecture with a fiber ring reduces wiring and installation costs
- » Fastest configuration software (Director)
- » Seamless integration of Bolero wireless intercom and SmartPanel user interfaces
- » Compatible with the latest market requirements on IP (ST2110 and NMOS) and JT-NM tested

Any comms solution is only as good as its configuration software – and the Director software is just one more differentiator that sets Artist apart from the rest. Powerful and user-friendly, Director offers industry-leading configuration upload times and an intuitive interface with drag-and-drop simplicity that gets people talking right out of the box. With Director, Artist is the only intercom that can load a full configuration in just a few seconds – even in large systems with hundreds of users.

Artist has seen countless additions to its feature set, on both the hardware and software side, as it has continued to evolve in response to industry developments. And now, its modular structure has facilitated a swift reaction to the paradigm shift from baseband to IP-based media infrastructures, making Artist the first fully SMPTE 2110-30/31 compliant intercom system available on the market.

ARTIST – System Overview

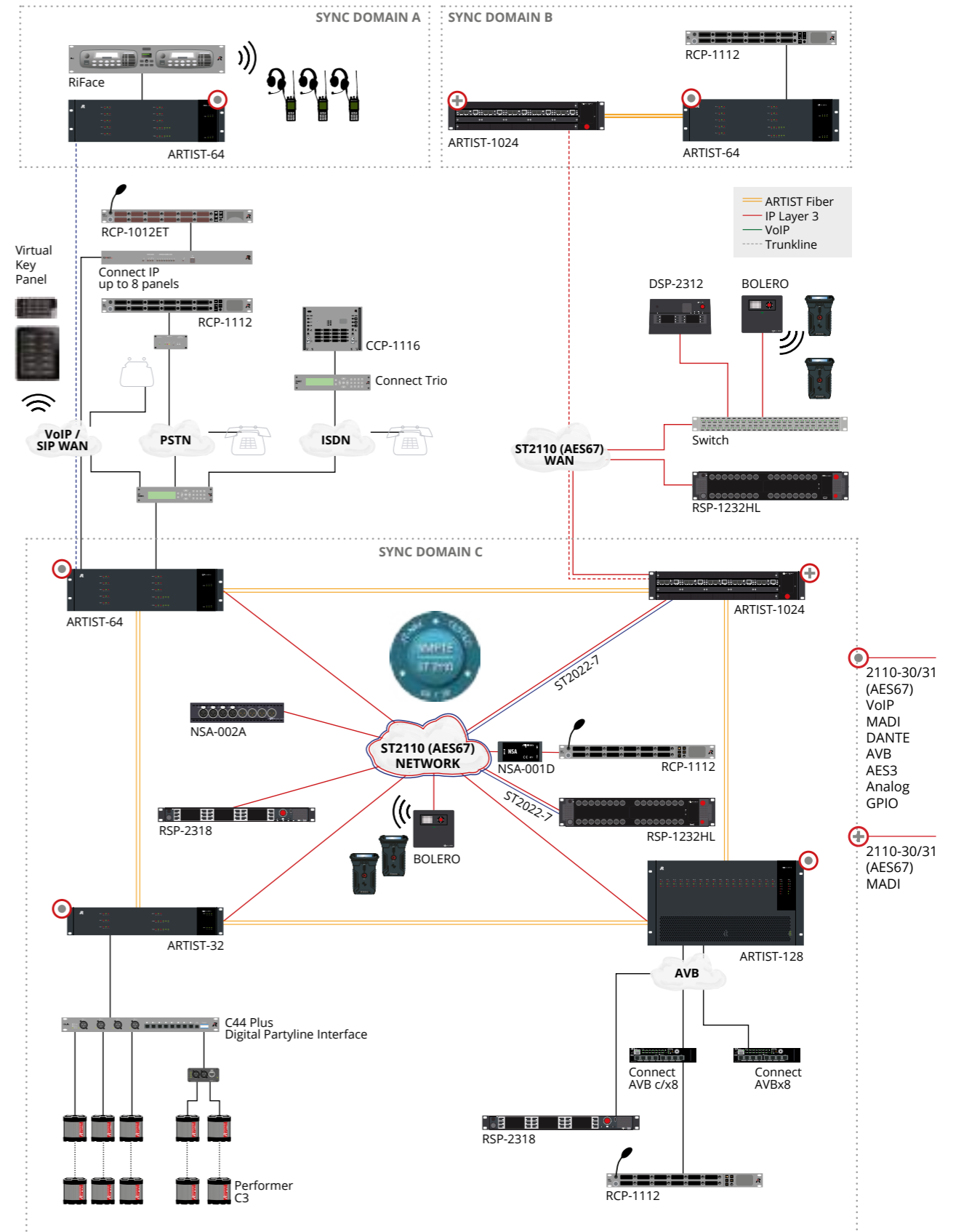

ARTIST-1024

The Next Piece of the Puzzle

Artist-1024 is the next evolutionary step in the continuous development of the Artist intercom ecosystem. This new node complements the Artist family, expanding its capabilities with a focus on IP-based installations and higher port densities. With Artist-1024, full compatibility is guaranteed. The node can be effortlessly added into any Artist fiber ring and, just like its siblings Artist-32, Artist-64, and Artist-128, is easily and intuitively configured within the Director software environment.

As its name suggests, the Artist-1024 node boasts 1024 non-blocking ports in just a 2RU frame size. This unparalleled port density significantly reduces rack space requirements and creates powerful efficiencies in any application where space is a critical factor. This latest addition to the Artist ecosystem introduces a range of technical innovations centered around a software-definable Universal Interface Card, the UIC-128-II. This entirely new type of interface card combines networking, mixing, and management and can be configured to act as a SMPTE 2110-30 (AES67), MADI or Dante subscriber card, or as an Artist fiber/router/processor card. Changing the connectivity type is as easy as reconfiguring the UIC-128-II with the click of a button in Director, Artist's powerful configuration software. With Director, this reconfiguration is completed within seconds! The physical SFP modules are also changed with ease, e.g. from fiber to copper.

The frame provides ten bays for UIC-128-II, with two being reserved solely for routing and networking UICs. The remaining eight bays can be flexibly equipped with UICs of various configurations to provide subscriber connectivity. The integral mixer on each subscriber card can be scaled from 8 to 128 bidirectional ports per card and can access all 1024 channels of the Artist backbone. Since UICs support internal sample rate conversion, each card can be connected to a different clock environment (MADI, PTPv2).

Artist-1024 has been architected with redundancy at its core. By supporting multiple redundancy schemes including manual N+1, NIC, and SMPTE 2022-7, it can provide an unprecedented degree of robustness and reliability. In addition to SMPTE 2022-7-compliant audio and control data stream redundancy, there are several redundancy mechanisms in place to avoid single points of failure: The manual N+1 subscriber redundancy scheme includes a hot spare card that can take over the configuration of any other subscriber card. With RRCS, it is now possible to fully provide automatic N+1 redundancy in any third-party driver. The NIC scenario allows a seamless handover between the two routing cards of a single node. As expected from a professional system, all control logic and data links within the frame are redundant. The advanced frame design provides additional security with two load-sharing PSUs and a fan module with redundant fan units. The sum of these measures equals the most comprehensive comms safety net available on the market.



The frame design is rounded off by an e-ink display that provides configuration and licensing information, even when powered off. Artist-1024 also offers flexible mounting options: The frame can be mounted with an offset of 0, 25, 50 or 75mm and can be rotated in the rack. If required, the ventilation can be reversed to provide efficient cooling in any situation.

Artist-1024's universal interface card (UIC) concept and its versatile licensing scheme give you unprecedented universal interface card (UIC) flexibility, scalability, and capability. With the ability to move ports between subscriber cards and flexibly assign connectivity types as needed, you can easily customize individual nodes, and the entire system, to fit the needs of your specific application. With Artist-1024 you get more than just full IP standards compliance and massive port densities. What you get is the full power of the sophisticated Artist intercom ecosystem, a versatile and future-proof solution that continues to evolve with industry developments and standards. With Riedel, you have a partner on your IP journey who is committed to push the boundaries of innovation and is passionate about shaping the future of production communications.

ARTIST-1024 – Key Benefits

- » 2RU frame with up to 1024 ports
- » High-density Universal Interface Cards (UIC) with up to 128 ports per card
- » Software-defined UICs can switch between SMPTE 2110-30/31 (AES67), MADI or router/processor/Artist fiber
- » New 2022-7 and N+1 redundancy schemes
- » Sample rate converter available on each UIC input
- » Flexible licensing scheme
- » Advanced frame design with reversible front-to-rear cooling

The Universal Interface Card (UIC)



One client card, many connectivity types:
The software-definable Universal Interface Card (UIC) with flexible licensing

What's a UIC?

- » Combines networking, mixing, and management
- » Configurable as a
 - SMPTE 2110-30/31 (AES67)
 - MADI subscriber card
 - Artist fiber/router/processor card
- » Reconfigurable with the click of a button in Director

Licensing Scheme

Artist-1024 introduces a new customer-friendly, flexible licensing scheme with frame-level licensing instead of connectivity-type licensing. Each node starts with a Virtual Artist Matrix (VAM) license which includes a defined number of ports (16 to 1024) that can be freely distributed across the node's subscriber cards. Additional ports can be licensed with Virtual Artist Expansion (VAE) licenses. Besides these node-locked licenses, there are also Flexible Virtual Artist Expansion (FVAE) licenses that allow for fast (re-) configuration of the system by simply moving capacities between nodes. Since the licensing model does not involve connectivity, systems can be freely altered to meet any connectivity requirement.

VAM = Virtual Artist Matrix License

- A cost-beneficial bundle of ports (16, 32, 64, 128, 256, 512, 1024)
- Node-locked to a 1024 node
- One VAM per node

VAE = Virtual Artist Expansion License

- Adds ports to a VAM in 16 port blocks
- Node-locked to a 1024 node
- Multiple VAEs per node

FVAE = Flexible Virtual Artist Expansion License

- Adds ports to a VAM in 16 port blocks
- Can be moved between 1024 node
- Multiple FVAEs per node

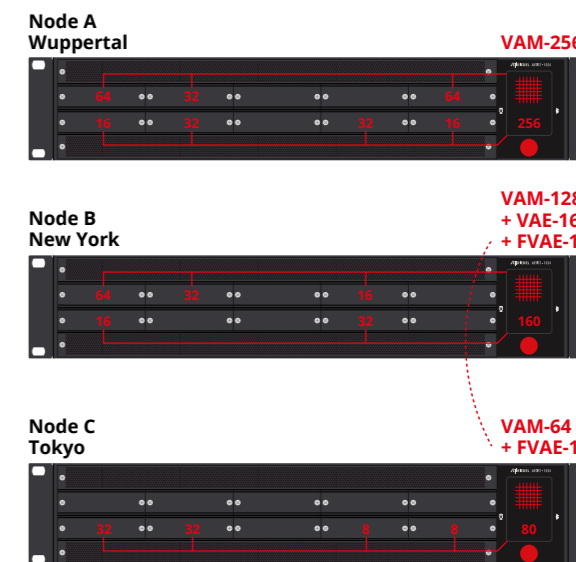

ARTIST at a Glance

Artist-1024

- 2 RU frame with up to 1024 ports
- Flexible licensing scheme
- Multiple independent sync domains per node
- 2022-7 and N+1 redundancy schemes
- E-ink display
- Reversible front-to-rear cooling

Universal Interface Card (UIC)

- Software-defined hardware that can be used as a router/processor, Artist fiber, MADI or SMPTE 2110-30 (AES67) device
- Scalable from 8 to 128 ports

Artist-32 / 64 / 128 / 1024

- Decentralized architecture with a fiber ring allowing rapid merging
- Seamless integration of Bolero
- SmartPanel user interface
- Supports current IP standards and architecture will support future standards
- Fastest configuration software
- Richest feature set (key functions, logics, options, etc.)
- Powerful configuration tools (MCR, RRCS, SNMP, Trunking)



32 / 64 / 128

- Unparalleled connectivity:
 - SMPTE2110-30/31 (AES67)
 - VoIP
 - MADI
 - DANTE
 - AVB
 - AES3
 - Analogue
 - GPIO

Intercom System

Product name	Artist Intercom
Non-blocking subscriber ports per ring	1024
Artist nodes per ring	50+
Trunked Artist rings	25+
Subscriber ports in trunked systems	6000+
Redundant fiber switchover	Fully automatic & seamless

Intercom Nodes

Product name	ARTIST-32	ARTIST-64	ARTIST-128	ARTIST-1024
Subscriber ports per node (min - max)	8-32	8-64	8-128	16-1024
Subscriber ports per card (min - max)	8	8	8	8-128
CPU / NIC card bays	2	2	2	2
Client / subscriber card bay	4	8	16	8
GPIO card bays	Client card bays	Client card bays	Client card bays + 2	-
Sync card / module bays	2	2	2	-
Display	-	-	-	E-ink
Mounting options	19" Rack Ears	19" Rack Ears	19" Rack Ears	19" Rack Ears (offset 0, 2.4, 5, 7.5cm) 180° rotatable
Width	19" / 483mm	19" / 483mm	19" / 483mm	19" / 483mm
Height	2RU / 88mm	3RU / 130mm	6RU / 264mm	2RU / 88mm
Depth	370mm	370mm	370mm	404mm
Weight (inc. PSUs and fan units)	5,15kg	5,6kg	11,8kg	6,3kg
Airflow direction	side-to-side	side-to-side	front-to-rear	front-to-rear (reversible)
Redundant PSUs	✓	✓	✓	✓
Hot swappable PSUs	✓	✓	✓	✓
Load-sharing PSUs	-	-	-	✓
Input voltage	90-264 VAC, 50/60 Hz	90-264 VAC, 50/60 Hz	90-264 VAC, 50/60 Hz	85-264 VAC, 50/60 Hz
Power consumption	max. 200W	max. 250W	max. 400W	max. 225W

Interface / Subscriber Cards

Artist Fiber	CPU-128F	CPU-128F	CPU-128F	UIC-128 or UIC-128-II
SMPTE 2110-30/31 (AES67)	AES67-108	AES67-108	AES67-108	UIC-128 or UIC-128-II
MADI	MADI-108	MADI-108	MADI-108	UIC-128 or UIC-128-II
VoIP	VoIP-108	VoIP-108	VoIP-108	-
DANTE	DANTE-108	DANTE-108	DANTE-108	UIC-128-II
AVB	AVB-108	AVB-108	AVB-108	-
AES3	AES-108	AES-108	AES-108	-
ANALOG	ANALOG-108	ANALOG-108	ANALOG-108	-
GPIO	GPI-108	GPI-108	GPI-108	-

Redundancy

CPU / NIC	✓	✓	✓	✓
Dual Fiber Ring	✓	✓	✓	✓
N+1 Redundancy	-	-	-	✓
SMPTE 2022-7	-	-	-	✓

IP Networking & Connectivity

SMPTE 2110-10 / -30 / -31	✓ / ✓ / ✓	✓ / ✓ / ✓	✓ / ✓ / ✓	✓ / ✓
SMPTE 2110-30	Level A & B	Level A & B	Level A & B	Level A & B & C
PTP	IEEE 1588:2008	IEEE 1588:2008	IEEE 1588:2008	IEEE 1588:2008
ST-2059-2 / Media Profile / AES R16	✓ / ✓ / ✓	✓ / ✓ / ✓	✓ / ✓ / ✓	✓ / ✓ / ✓
IP Layer3 WAN	VoIP, SMPTE 2110-30/31	VoIP, SMPTE 2110-30/31	VoIP, SMPTE 2110-30/31	SMPTE 2110-30
IGMPv3 / SSM	✓ / ✓	✓ / ✓	✓ / ✓	✓ / ✓
JT-NM TR-1001:1	✓	✓	✓	✓
DHCP	✓	✓	✓	-
DNS	✓	✓	✓	-
NMOS IS-04 / -05	✓ / ✓	✓ / ✓	✓ / ✓	✓ / ✓
SDP import / export	✓ / ✓	✓ / ✓	✓ / ✓	✓ / ✓
In-band / out-band control	- / ✓	- / ✓	- / ✓	✓ / ✓

DIRECTOR

Intuitive Configuration Software



Access, set-up and control of any aspect of an Artist system consisting of hundreds of intercom ports on multiple nodes is achieved using the comfortable and intuitive Director configuration software.

Director provides the facilities, look and feel of most Windows software products, so that the basic navigation, location and operation of the standard features are familiar. It's quick to learn and extremely convenient to use. Configurations are easily edited by drag-and-drop. Programmable logic functions provide the possibility to handle even complex production requirements with ease, while freely definable markers allow a customized control of the system. With the Audio Patch function, all internal routing and DSP aspects of any control panel of an Artist system can be configured and saved remotely reducing a considerable amount of time in set-up and service of the system.

A high degree of monitoring and diagnostic features are implemented allowing maintenance personnel to quickly solve a problem or to assist a user – even in complex IP installations. This is achieved by the real-time Crosspoint View function in conjunction with the full remote control of each aspect of the system. Control panels and matrix activities can be logged for later inspection. Multiple PCs can control and monitor the system using the Ethernet connection on the network interface controllers. All PCs show the online configuration status simultaneously; and each can access and change the configuration according to its user rights. Since the configurations are stored within each networking Artist frame, the system's reliability won't be affected by the failure of a configuration PC.

An extensive user level control allows for setting up user groups with dedicated access rights to the system. Not only whole configurations, but also parts of configurations can be saved and reloaded as "partial files". This allows system setups for different types of productions to be easily stored and recalled.

DIRECTOR – Key Benefits

- » Intuitive user interface
- » Easy to learn and use
- » Drag-and-drop configurations
- » Real-time status of the entire system
- » IP configuration and IP statistics for ST2110 networks
- » Multiple PC access with user level control
- » Configurations are stored in the matrix
- » Remote control
- » Real-time cross point view
- » Versatile IFB tools
- » Audio patches
- » Programmable logic functions
- » Free definable markers

Add-on Features

The modularity of the Artist platform is also implemented with the Director configuration software. The powerful Director configuration tool can be further enhanced by modular software add-ons like RRCS, Trunk Navigator, Partial Files, Audio Video Router or the Master Control Room.

Partial Files

The Partial Files add-on saves not only entire configurations but can also save just a portion of a configuration. These "partial files" can be reloaded so that system setups for different types of productions can be easily stored and recalled.

Audio/Video Router Interface

With this optional software package, the system continuously monitors up to two external routing switchers and provides conference-based tracking of your Artist intercom system.

Events/Scheduler

The Events/Scheduler add-on is a versatile tool to automatically trigger pre-defined events (including MCR conferences) or configuration changes.

Master Control Room

With Master Control Room, the individual conference intercom systems or 4-wire conference systems found in many broadcast installations can be easily replaced and integrated into the main intercom system. An integrated scheduler allows for pre-programming the start of regular conferences, e.g. the daily editorial conference at 9:00 am.

Riedel Router Control Software (RRCS)

The Riedel Router Control Software (RRCS) provides a universal XML interface for enabling third party router control systems to control Riedel Artist Intercom systems. The RRCS Software features an expanded set of XML commands for the software to allow for an even deeper integration of external third party control systems and Artist.

Trunk Navigator

Riedel's Trunk Navigator Software enables you to comfortably network geographically separate Artist Intercom systems by dynamically allocating audio trunk lines between their locations. This way, several thousand subscribers can be connected within a single ecosystem. The trunk lines can be established with ATM, ISDN, VoIP, digital leased lines or analog land lines. The redundancy design enables the software to run on two computers simultaneously and switch seamlessly from one computer to the other in the case of a failure.

ACTOR – RTS®/Telex® Trunking Interface

The Riedel Actor is a revolutionary solution that allows intelligent trunking between Riedel Digital Matrix Intercom systems and existing RTS®/Telex® intercom installations (using Trunkmaster version 8.71). It provides seamless communications between both systems. This includes all point-to-point connections with port alpha transfer and tally as well as IFBs, group calls and conferences (partylines). Actor helps to secure previous intercom investments and enables customers to proceed in future intercom installations with an Riedel Digital Matrix Intercom solution.

RTS & Telex are registered trademarks of Bosch Security Systems Inc.

RIEDEL SmartPanels – The Multifunctional User Interfaces

Riedel's SmartPanel concept decouples a keypanel's capabilities from its hardware and turns it into a generic device on which you may install apps for different purposes. Therefore, you do not only buy what the panel is capable of today – but benefit also from what the panel will be capable of in the future.

Riedel SmartPanels – Features

- » SmartPanel concept - turning an Intercom panel into a true multi-purpose device
- » High-resolution, sunlight-readable multi-touch displays
- » Ergonomic key design suited for any workflow
- » Individual listen level controls to adjust the level of each talk key
- » Wide range of connectivity options
- » Full support of SMPTE 2110-30/31 (AES67)



1200 Series SmartPanels

Building upon the technology that powers Riedel's SmartPanel App-driven user interfaces, the new 1200 series represents a quantum leap forward in workflow flexibility, power, and connectivity. Featuring multiple true-

color multi-touch displays, 32 innovative hybrid-lever keys, and the ability to easily adapt to the various workflows in use today, this new panel is poised to allow you to work the way you always have while opening up entirely new possibilities. Completely new from the ground up, the new 1200 Series SmartPanel RSP-1232HL (Hybrid Lever) is Riedel's smartest SmartPanel yet.



2300 Series SmartPanels

With the 2300 Series, Riedel introduced the world's first SmartPanel. Its unique feature set includes high-resolution, multi-touch color displays, premium quality stereo audio, as well as a multilingual character set. The 2300 Series is an "open platform" for applications that is natively fully compliant with SMPTE-2110-30/31 (AES67) and is also AVB and AES3 compatible. The 2300 Series panels are essentially two devices in one. In addition to the Intercom app, the MediorNet Control App allows to route and control audio and video signals within MediorNet media networks.



Riedel Virtual Panels

The Riedel Virtual Panels allow a regular computer or a mobile device to function as an intercom control panel in combination with any Riedel digital matrix intercom system. The communication between the matrix and the virtual panel is handled via the VoIP-108 G2 client card.

1200 Series SmartPanel



2300 Series SmartPanel

Features	1200 Series SmartPanel	2300 Series SmartPanel
Displays	High-resolution sunlight readable true color TFT (touchscreen)	High-resolution sunlight readable high-color TFT (touchscreen)
Key Type	Hybrid lever (lever with integrated rotary encoder)	Pushbutton (with touchscreen)
Individual Volume Control	✓ (integrated rotary for each key)	✓ (touch gesture)
Sidetone Adjustment	✓ (via secondary rotary)	✓
Key Banks	✓	✓
Maximum Characters (per key)	8 (main title) 16 (subtitle)	When connected to Artist G2: 8 when connected to Artist-1024: 8 (main title) 16 (subtitle)
Icon Support	✓	✓
Function Keys	Touch-enabled Info Display; context sensitive secondary functions per key	Headset/panel mic, Mute, Shift page, Menu
Digital Matrix Connection	SMPTE 2110-30/31 (AES67) optional: AES3, VoIP	SMPTE 2110-30/31 (AES67), AES3, AVB, optional: VoIP
Analog In/Out	2 / 2 (RJ45)	2 / 2 (RJ45)
GPI In/Out	3 / 3 (9-pin female D-sub)	3 / 3 (9-pin female D-sub)
Headset Connections	2 (XLR4, RJ45)	2 (XLR4, RJ45)
Connectivity	Matrix: BNC, RJ45 Ethernet: 2x RJ45, 2xSFP	Matrix: BNC, RJ45 Ethernet: 1x RJ45
Loudspeaker	RSP-1232HL: 2 (stereo, full-range) RSP-1216HL: 1 (stereo, full-range)	1 (full-range)
Supported Character Sets	Latin Cyrillic Kanji Katakana	Latin Cyrillic Kanji Katakana
Types		
Rack-mount	RSP-1232HL (32 keys, 2RU 19", depth: 95 mm / 3.7") RSP-1216HL (16 keys, 2RU 19", depth: 95 mm / 3.7")	RSP-2318 (18 keys, 1RU 19", depth: 79 mm / 3.1")
Expansion		ESP-2324 (24 keys, 1RU 19", depth: 79 mm / 3.1")
Desktop		DSP-2312 (12 keys)
Software Licenses		
Intercom App	✓	✓
AES3 License Add-On	✓	-
AES67 4-Wire License Add-On	✓	-
MediorNet Control App	-	✓
Control Panel App	✓	-
Audio Monitoring App	✓	-

1200 Series SmartPanel



Building upon the technology that powers Riedel's SmartPanel app-driven user interfaces, the 1200 Series SmartPanels represent a quantum leap forward in workflow flexibility, power, and connectivity. Featuring multiple full-color multi-touchscreen displays, innovative hybrid lever keys, the ability to leverage apps for multifunctionality, and the ability to easily adapt to the various workflows in use today, these new panels are poised to allow you to work the way you always have while opening up entirely new workflow possibilities.

The 1200 Series SmartPanels are Riedel's smartest panels yet! The SmartPanel concept decouples the panel's capabilities from its hardware and turns it into a generic device on which customers can install different apps to enable different capabilities. With a Riedel SmartPanel, you not only get what the panel is capable of today – but also what it will be capable of in the future.

The 1200 Series **Intercom App** supports multiple workflows. Some comms users prefer a "Talk/Listen" workflow where the user chooses what to listen to from an initially silent panel. Other users prefer a "Talk/Mute" workflow that starts with a panel that broadcasts everything, with the users selecting which signals to turn off. Users can decide which mode they prefer on a per-panel basis. New features that further enhance the panel's ease of use include Riedel's Logical Groups concept. Logical Groups allow users to choose custom colors for the key labels or the LED rings around the keys. Each key label has an 8-character main label, a 16-character sub label, and user-defined icons. Other icons provide information about the state of each key at any point in time. The "open mic", "muted key", "incoming beep", or "port busy" prompts are easy to read and understandable at a glance. Users can get as much or as little information about any given key as needed.

Connectivity is king at Riedel. Our SmartPanels take advantage of the AES3 digital connectivity that Riedel has always used along with SMPTE 2110-30 (AES67) connectivity. The AES67 connection is provided via fiber SFPs or RJ45 connections, which offer a variety of redundancy options to realize extraordinary cabling flexibility and resilience. Speaking of resilience: the 1200 Series SmartPanels are the world's only keypanels featuring SMPTE 2022-7 redundancy. Stereo speakers optimized for high speech intelligibility and audio fidelity maintain a balanced sound even at high volume levels. Other features include front-panel mic mute and sidetone adjustments, front/rear USB ports, Bluetooth and NFC connectivity, GPIO and 4-wire ports.

With the **Control Panel App**, third-party control, monitoring, and automation systems can be adapted to the SmartPanel's easy-to-use and highly intuitive user interface. Its feature set is surprisingly simple but incredibly powerful. Users can trigger actions in third party systems with the panel's keys and rotaries, and get visual feedback on configuration status and changes via colors, labels, and symbols on touchscreens and LEDs. The Control Panel App is built on open NMOS standards for easy interoperability and scalability. Key to this is the NMOS IS-07 standard which allows the exchange of event/state information (e.g. the press of a button or the color of an LED) across systems of different vendors.

The **Audio Monitoring App (AMA)** enables operators to monitor audio streams while managing a production via the Intercom App. This makes the 1200 Series SmartPanels the only devices that can operate intercom and audio monitoring simultaneously! The AMA allows a direct connection to any SMPTE 2110-30 (AES67) stream available on the network – either dynamically managed via NMOS or in a static SDP-based configuration, mixing the audio directly inside the SmartPanel. The AMA is SMPTE 2022-7 capable and can be configured via a dedicated configuration tool or a broadcast controller using the built-in API. In addition, the selection and management of monitored audio sources is incredibly simple and flexible. SmartPanel users can monitor up to 16 stereo/mono SMPTE 2110-30 (AES67) streams in parallel while a total of 256 Audio Monitoring Sources can be pre-configured and managed directly on the panel. Because of the SmartPanel's intuitive user interface and its high-resolution LC touch displays, operators can easily manage the audio monitoring sources on the panel by themselves. With the Audio Monitoring App and the Intercom App running on the same endpoint, users will never miss an important intercom call when monitoring an audio source, as the monitoring volume can be dimmed in case of an incoming call. This is possible since the inter-application behaviour can now be predefined in the configuration. If operators don't want to get distracted by calls, the inter-application behavior can also be configured to automatically dim the audio coming from the Intercom App when soloing an audio source. With the SmartPanel's high-fidelity speakers, the intuitive UI and the ability to manage the inter-app behavior, the AMA makes a separate audio monitor obsolete and enables users to save cost and rack space while delivering an improved workflow.

The smartest SMARTPANELS™



RSP-1232HL
RSP-1216HL
ESP-1216HL



BACK VIEW

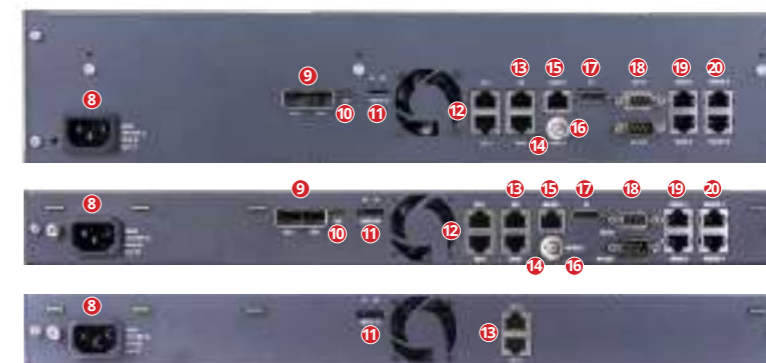

Front view

- 1 Logical groups:
Choose custom colors for key labels or LED rings
- 2 High-resolution, bright color, sunlight readable TFT displays with multi-touch control
- 3 2x multi-touch color key displays
- 4 32x/16x hybrid lever keys with rotary encoder & LED key rings
- 5 NFC / Bluetooth connection (future use)
- 6 Front USB connector
- 7 Rotary encoder (sidetone control & menu navigation)

Back view

- 8 Power supply
- 9 2x SFP slots (AES67/ethernet)
- 10 Rear USB connector
- 11 MicroSD card slot
- 12 2x ethernet connectors (AES67/ethernet)
- 13 Expansion port
- 14 Management port
- 15 Artist matrix connector (AES3)
- 16 Artist coaxial connector (AES3)
- 17 DisplayPort (future use)
- 18 GPI input/output connectors
- 19 2x analog 4-wire input/output connectors
- 20 2x headset connectors

Unique key design: The Hybrid Lever Key

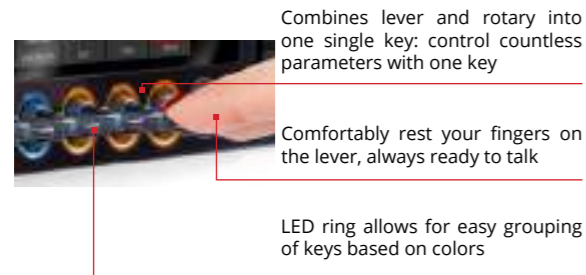

Full color, high-resolution, sunlight readable touch screen



Info Display & Key Banks

No mixing of “operating mode” and “menu mode”
Stay fully operational (i.e. you do not lose access to your intercom keys) when accessing additional settings or menus
Find additional information and navigation for your current working context (e.g. key banks)



Create one page with all relevant keys for your show rehearsal



Quickly change to all relevant keys for your live setup with just one tap
Users can still see status messages (open mics, incoming calls, and other) from key banks which are currently not visible

Logical Groups

Quickly identify the teams / team members you need to talk to
Flexibly choose between 16 individual group colors and assign them to either the key label or the LED color ring
Create a simple way to show relationships between keys



Assign group colors to the LED rings or on the key labels

Hardware Front Elements	RSP-1232HL	RSP-1216HL
Keys & rotaries	32x software-assignable lever keys with rotary encoder and push button 2x rotary encoders	16x software-assignable lever keys with rotary encoder and push button 2x rotary encoders
Displays	3x high-resolution, bright color, sunlight readable TFT displays with multi-touch control (capacitive)	
Mic	1x threaded 6.3 mm jack for microphone 1x internal panel microphone (future use)	
Headset	User-exchangeable headset connector with preinstalled 4-pin male XLR connector	
Speaker	2x full-range, DSP-controlled	1x full-range, DSP-controlled
USB	USB 1x USB 2.0 (standard Type-A, max. 500 mA)	
NFC	Technology RFID, frequency 13.56 MHz (future use)	
Bluetooth	Frequency DTS band 2400 ... 2483.5 MHz (future use)	
Light sensor	Adaptation of the display brightness to the environment (future use)	

Hardware Rear Elements	RSP-1232HL	RSP-1216HL
IEC	Power input	
SFP	2x ethernet ETH 3 / ETH 4 (1000BASE-X, Ethernet, AES67)	
USB	1x USB 2.0 (standard Type-C, max. 500 mA)	
MicroSD card	1x MicroSD / MicroSDHC card up to 32 GB (for service purpose only)	
RJ45	2x ethernet ETH 1 / ETH 2 (1000BASE-T Ethernet, AES67) 1x expansion port for expansion panels 1x management port for panel configuration (future use) 1x Artist matrix connector (AES3) 2x analog audio 4-wire inputs and outputs 2x headset (“Headset A” is identical to front)	
BNC	1x Artist matrix connector (AES3)	
DisplayPort	1x DisplayPort connector (future use)	
Sub-D9 (male)	3x GPI output, Umax 48 V / 300 mA, protected by self-healing fuse	
Sub-D9 (female)	3x GPI input, Uin = +5 V ... +48 V	

Audio Specs	RSP-1232HL	RSP-1216HL
Maximum level	Audio A/B input // output Headset phones Headset microphone Internal speaker	+24 dBu // +24 dBu +20.5 dBu +6 dBu max. 110 dB SPL max. 101 dB SPL
Frequency response	Panel/internal mic (electret) Headset mic A/B Headset phones Audio A/B input // output Internal speaker	70 Hz ... 20 kHz, -3 dB (70 Hz high-pass filter) 20 Hz ... 20 kHz, -0.1 dB 20 Hz ... 20 kHz, -0.4 dB 20 Hz ... 20 kHz, -0.4 dB // 20 Hz ... 20 kHz, -0.3 dB 120 Hz ... 16.6 kHz, -10 dB // 140 Hz ... 16.6 kHz, -10 dB
Sample rate / resolution	48kHz / 24 Bit	

General	RSP-1232HL	RSP-1216HL
Power	Supply voltage Power consumption	100 – 240 VAC, 50 – 60 Hz ≤20 W, ≤70 BTU/hr
Dimensions	Form factor Width x height x depth	19”, 2 RU 483 (445) x 88 x 138 (95) mm / 19 (17.5) x 3.5 x 5.4 (3.7)” outer dimensions (installing dimensions)
Weight		3.4 kg / 7.4 lbs
Cooling	Fan noise (temperature controlled fan)	<23 dB(A) idle, 34 dB(A) max. fan speed @ 0.7m (noise emission meets GK15 / DIN 15996)
Environment	Operating temperature Storage temperature Humidity Max. altitude	0 ... +45°C -30 ... +80°C 20 ... 90 % relative (non-condensing) 3000 m AMSL

Software Licenses	RSP-1232HL	RSP-1216HL
Intercom App Pro	✓	✓
AES3 License	✓	✓
AES67 4-Wire License	✓	✓
Control Panel App	✓	✓

Accessories	RSP-1232HL	RSP-1216HL
MIC-30 electret microphone, cardioid, length 30cm	✓	✓
MIC-3 electret microphone, cardioid, length 3cm	✓	✓

2300 Series SmartPanel

RSP-2318

With the RSP-2318, Riedel introduced the world's first SmartPanel. The RSP-2318 SmartPanel is a compact, 1RU intercom panel featuring three high-resolution, sunlight readable, multi-touch color displays. The RSP-2318 is an "open platform" for applications that is natively fully compliant with SMPTE-2110-30 (AES67) and is also AVB and AES3 compatible.

The RSP-2318 essentially is two devices in one. In addition to the Intercom App, the MediorNet Control App allows to route and control audio and video signals within MediorNet media networks.

RSP-2318 panels also come with 18 keys, high-quality stereo audio, multi-lingual character support and individual volume control. Supporting up to 4 expansion panels, the RSP-2318 allows for a high key density of 114 keys in 5RU.

Needless to say, the RSP-2318 SmartPanel provides backwards compatibility and thus can be integrated in any existing Riedel installation, allowing for smooth interoperability between all Riedel intercom systems, such as Artist, Tango, and Performer.



What's a SmartPanel?

It is an open app-based user interface, with integrated multi-touch technology designed to bring your workflow to a whole new level.

Riedel RSP-2318 – Key Features

- » Open expandable platform for applications
- » 18 keys
- » 3x high-resolution, sunlight-readable displays
- » Intercom and control panel in one device
- » Individual volume control
- » Intuitive touch-screen UI
- » Integrated power supply

DSP-2312

Being one of the smallest desktop panels on the market, the DSP-2312 brings all the SmartPanel benefits in a small form factor perfectly suited for narrow production environments. Its compact design features integrated tripod mounting options as well as ergonomically optimized key positions.

Riedel DSP-2312 – Key Features

- » Open expandable platform for applications
- » 12 keys
- » 2x high-resolution, sunlight-readable displays
- » Ergonomic design for use in narrow production areas
- » 1/4"-20 threads for use with tripods or magic arms for any installation environment
- » Intercom and control panel in one device
- » Individual volume control



Tech Specs

Environmental Temperature	0 °C ... +45 °C
Supply Voltage	100 ... 240 VAC, 50 / 60 Hz
Power Consumption	15 W / ≤ 30 W (typ. / max.)
Form Factor	Desktop Panel
Dimensions (w×h×d)	262 mm × 84 mm × 179 mm / 10.3" × 3.3" × 7.1"
Weight	1.81 kg / 4.0 lbs

RSP-2318

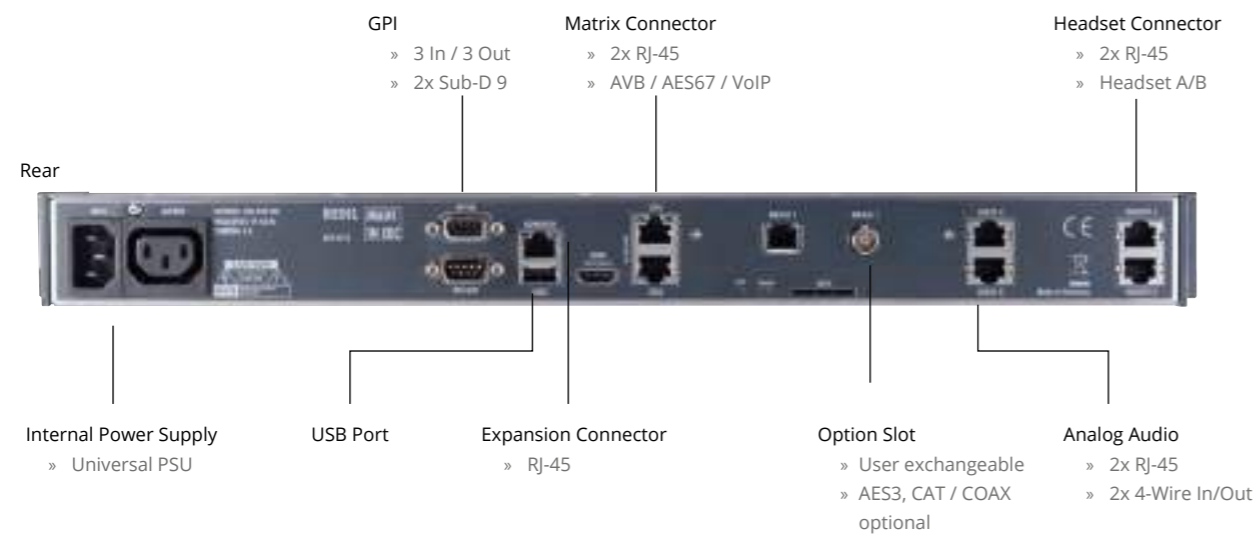
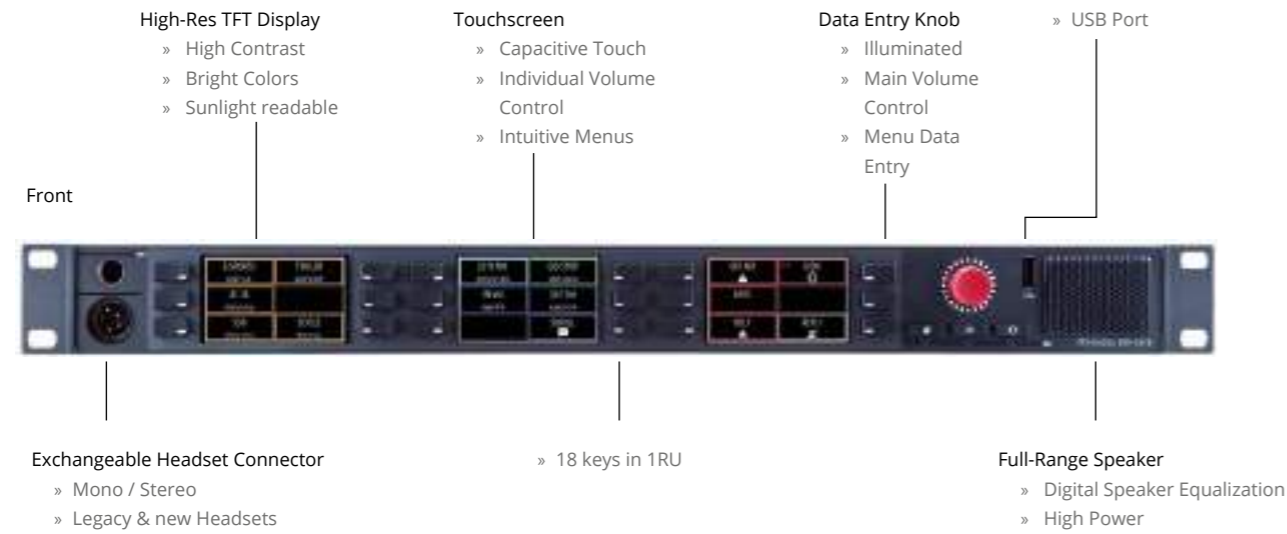

Tech Specs

Environmental Temperature	0 °C ... +45 °C
Supply Voltage	100 ... 240 VAC, 50 / 60 Hz (redundant)
Power Consumption	≤ 30 W
Form Factor	19", 1 RU
Dimensions (w×h×d)	446 mm × 44 mm × 79 mm / 17.6" × 3.1" × 1.7"
Weight	1.7 kg / 3.8 lbs

ESP-2324

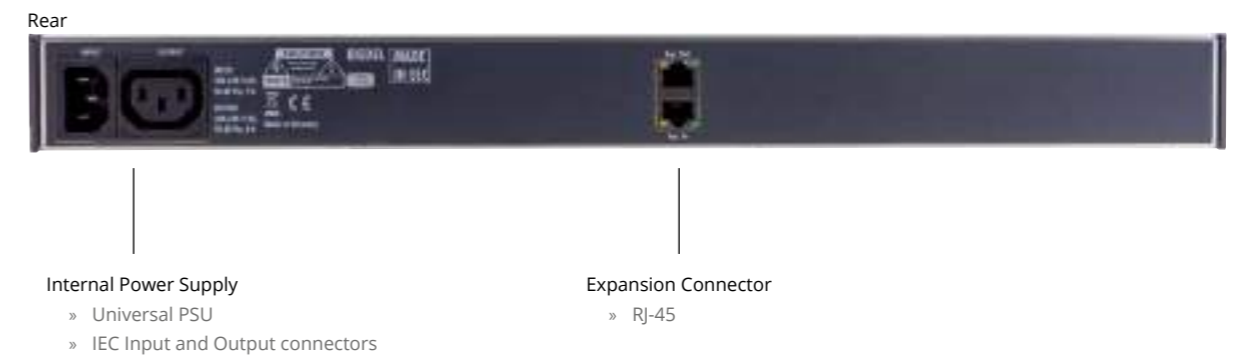
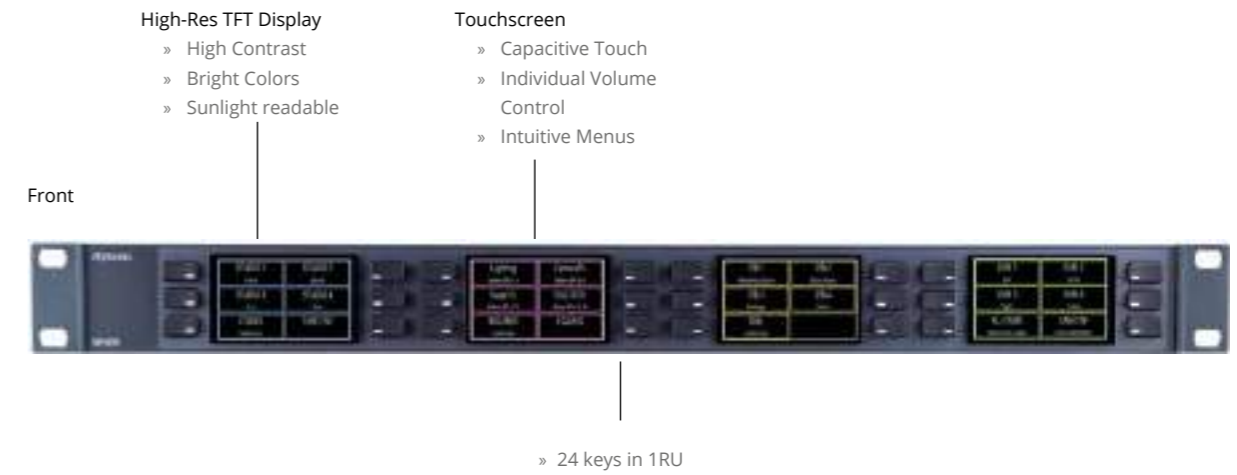

Tech Specs

Environmental Temperature	0 °C ... +45 °C
Supply Voltage	100 ... 240 VAC, 50 / 60 Hz (redundant)
Power Consumption	≤ 5 W
Form Factor	19", 1 RU
Dimensions (w×h×d)	446 mm × 44 mm × 79 mm / 17.6" × 3.1" × 1.7"
Weight	1.4 kg / 3.1 lbs

SmartPanel Apps

Intercom App

2300 Series SmartPanels come with a choice of three intercom apps, each with a range of connectivity options to meet specific user requirements and keep costs low: You only pay for those features you actually need.

The 1200 Series Intercom App already includes all features of the 2300 series while adding unique features like Logical Group colors and Key Banks as well as rich connectivity options.

	2300 Series			1200 Series
	BASIC	PLUS	PRO	PRO
Intercom Keys	12	12	18	16/32
Individual Volume Control	✓	✓	✓	✓
Multi-touch Displays	✓	✓	✓	✓
AVB	✓	✓	✓	-
AES67	✓	✓	✓	✓
GPI (In/Out)	-/-	3/3	3/3	3/3
Audio I/O A	-	✓	✓	✓
Audio I/O B	-	-	✓	✓
Headset A	✓	✓	✓	✓
Headset B	-	✓	✓	✓
Expansion Panels	-	✓	✓	✓
Key Banks	✓	✓	✓	✓
Panel Mic, Panel Speaker	✓	✓	✓	✓
Logical Group Colors	-	-	-	✓

MediorNet Control App

2300 Series SmartPanels are essentially two devices in one. In addition to the Intercom app, the MediorNet Control App allows to route and control audio and video signals within MediorNet media networks. MediorNet Control App can be used simultaneously with the Intercom App on the same SmartPanel.

	2300 Series	
	RSP-2318	DSP-2312
Control Keys	18	12
Expansion Panel Support	✓	-
Shift Page	✓	✓
Audio I/O	34/34	34/34
Video I/O	34/34	34/34
GPI I/O	34/34	34/34
Macros	34	34
Macro depth	100	100
Panels per network running MediorNet Control	25	25
MediorNet 3rd-party IDs	250	250
Configuration via browser	✓	✓

Control Panel App

API based on open NMOS standards:
Discover via IS-04, connect via IS-05, transport via IS-07



Trigger actions in 3rd party control, monitoring and automation systems

Get visual feedback on configuration status and changes

The Control Panel App brings the user interface of a 3rd party control, monitoring and automation system onto the easy-to-use and highly intuitive UI of the SmartPanel. The user can manage complex multi-step workflows through a user-friendly remote panel.

Each 3rd party control system supporting NMOS IS-07 will be able to natively use the Control Panel App. In addition, the Control Panel App can be connected to multiple control systems at the same time.

	1200 Series
16 or 32 configurable keys (selectable in blocks of 8)	✓
1 dedicated keybank	✓
NMOS integration	✓
Easy setup via WebUI	✓
works standalone or along with other APPs on the same Hardware	✓
Parallel use of Control Panel App and Intercom App and switch via keybank view	✓

Audio Monitoring

Monitor up to 16 stereo or mono AES67 channels from a total of 256 pre-configurable sources



Select audio streams and monitor audio levels

Benefit from the panel's high-fidelity sound, making a separate audio monitor obsolete

The Audio Monitoring App enables users to monitor their audio streams while managing a production via the Intercom App. The app directly connects to any SMPTE 2110-30 (AES67) stream available within the network, either dynamically managed via NMOS or in a static SDP-based configuration, mixing the audio directly inside the SmartPanel. Users can monitor up to 16 stereo SMPTE 2110-30 (AES67) streams in parallel while a total of 256 stereo channels can be pre-configured and managed directly on the panel.

Application Software

System Overview	Audio Monitoring App (V1.0)
Max number of sources (joined simultaneously)	16
Max number of potential Audio Monitoring Sources (select from list)	256
Max number of monitoring Sources (assigned on keys)	16
1 dedicated keybank	✓
Works standalone	✗
Works along with other Apps on the same hardware	✓
Parallel use of Audio Monitoring App, Control Panel App and Intercom App (in Artist-1024 mode) and switch via keybank view	✓
Use audio monitoring app and Intercom app simultaneously (within the same key bank)	✗

Capabilities & Connectivity

Supported Hardware Interfaces	Audio Monitoring App (V1.0)
RSP-1232HL	✓
RSP-1216HL	✓
ESP-1216HL	✗
2300 Series	✗

Supported Audio Standards / Formats	Audio Monitoring App (V1.0)
SMPTE 2110-30 (AES67)	✓
SMPTE 2022-7 (redundancy)	✗
Mono	✓
Stereo	✓
2300 Series	✗

Configuration	Audio Monitoring App (V1.0)
Receive Audio Monitoring Source configuration from a 3rd party control system (via RestAPI)	✓
Change key assignment channels on the panel (Select from Source List)	✓
Secondary Drawer support (open Source List, Normalize, Isolate, Mono Sum)	✓
Configuration via dedicated Config Tool	✓

Stream Allocation	Audio Monitoring App (V1.0)
Static IP configuration (via SDP)	✓
NMOS based configuration	✓
Channel Mapping via NMOS IS-08	✓

User Interface	Audio Monitoring App (V1.0)
Source Labels	✓
Subtitle	✓
Icons	✗
Group Color	✓
Metering	digital Level meter
Clipping Indication	✓

Functions	Audio Monitoring App (V1.0)
Mute/Unmute individual Sources	✓
Mute/Unmute individual Source legs (Isolate)	✓
Create Monosum from Stereo Source	✓
Solo individual Sources	✓
Individual Sources volume control	✓
Normalize volume for individual monitoring keys	✓
Mono signal on a key	✓
Stereo signal on a key	✓
5.1 downmix signal on a key	✗
Route to individual speaker / HS	✗
Ducking function	
· Incoming Intercom Call ducks AMA (ducking level adjustable)	✓
· AMA Solo function ducks Intercom (ducking level adjustable)	✓

Audio Outputs	Audio Monitoring App (V1.0)
Headset A (Front/Rear)	✓
Headset B (Rear)	✗
Speaker(s)	✓
Audio A/B	✗

Intercom goes Commentary: Riedel Commentary Control Panel



Riedel Commentary Panel – Features

- » High-quality microphone preamplifier with 48V supply, transformer balanced input, low-cut, +6dBu Limiter and level meter
- » All line inputs electronically balanced, all line outputs transformer balanced
- » Large illuminated push-button switches for ON AIR and COUGH/MIC MUTE
- » 16 free programmable intercom keys with 8 character high-resolution OLED displays
- » Additional programmable and remote controllable mono line input (e.g. to feed local playback sources) and speaker output
- » High quality headphone amplifier with monitor mix section: 3 source level controls, sidetone and overall level
- » Elaborated split-ear operation for commentary headphones: all sources routable
- » Standalone/emergency mode operation
- » Power supply redundancy via DC connector
- » Quick and easy set-up

The Riedel CCP-1116 is a commentary unit for two commentators with integrated intercom functionality. The device provides up to two commentary positions with high-quality mic pre-amps and all the intercom features known from Riedel Digital Matrix Intercom systems.

Combined in one compact device and cabled via one single CAT5 or COAX cable, the CCP-1116 reduces cabling effort, set-up time and points of failure. In addition, the CCP-1116 provides a clearly arranged user interface with improved functionality at the commentary position including programmable buttons for communications and GPIOs as well as remote control of the commentary panel.

In case of failure within the system – e.g. loss of the cable connection in between a CCP-1116 and the matrix – the standalone/emergency mode will be established without a loss of signal. ON AIR and MIC DIRECT OUT audio signals are available separately and A/B combined at XLR outputs of the CCP-1116. AUX IN XLR inputs feed the Phones Monitor Mix and thus replace the monitor signals.

Intercom Controls:

16 free programmable intercom control keys with individual listen volume controls. For two-user operation the set of keys can be split, resulting in 8 intercom keys per commentator. Following Riedel's intuitive concept of integrated displays in the panel keys, the 1100 series features the next generation of high-res colour OLEDs. With 65,000 colours and a resolution of 140 dpi, these new displays provide excellent readability and are able to show up to eight highly detailed characters of up to 24x24 pixels – ideal for displaying icons or Asian characters. Definable marker colours for the keys complete the labelling options and provide instant function identification and signalization, e.g. for incoming calls. Function keys for fast operation: headset/panel mic, shift-page, F1, F2, options.

BOLERO
DIGITAL
WIRELESS
INTERCOM



BOLERO – Riedel’s state-of-the-art wireless intercom system

As an all-new wireless intercom system capable of supporting up to 250 beltpacks and 100 antennas in a single deployment, Bolero is a true game-changer. Bolero redefines the wireless intercom category with features such as its ADR (Advanced DECT Receiver) with multi-diversity and anti-reflection technology for greater RF robustness, “Touch&Go” NFC beltpack registration, and versatile operation as a wireless beltpack, a wireless keypanel, or — in an industry first — a walkie-talkie.

With the addition of the newest Bolero Standalone 2110 (AES67) mode, there are now three network modes available for Bolero systems – each of them dedicated to specific applications.

Bolero **Integrated** leverages the powerful Artist ecosystem, including SmartPanels and extensive I/O connectivity, and runs over a standards-based SMPTE 2110-30 (AES67) IP network. Decentralized Bolero antennas connect to AES67-capable switches and to Artist frames equipped with AES67 client cards, providing a fully integrated point-to-point seamless handover intercom ecosystem. With each decentralized antenna added, coverage and network robustness are increased. Up to 250 beltpacks per Bolero Net are now supported.

Bolero **Standalone Link** provides plug & play simplicity that is ideal for smaller installations, portable deployments, or cases where IP networks are not required. Up to 100 antennas and 100 beltpacks can be quickly and easily set up and configured via a web browser, without the need for an Artist Intercom matrix since audio mixing and all control functions are handled by the antennas. Antennas may be positioned in a redundant ring or daisy chain topology using CAT5 cabling. With the optional EPS-1005 power supply, up to five antennas can be powered and adding multiple PSUs creates a redundant power ring. Finally, an NSA-002A stream adapter is used to interface Bolero with other intercom systems via analog 4-wire and provide GPIOs for convenient external device handling.

Similarly, Bolero **Standalone 2110 (AES67)** lets users establish IP-based Bolero networks without the need for an Artist matrix. The antennas are distributed over a SMPTE 2110-30 (AES67) IP network and connected via AES67 PoE switches. Up to 100 antennas and 100 beltpacks can be accommodated per Bolero Net and configured via a web browser. In Standalone Link deployments, audio mixing and control functions are handled by the antennas; the optional NSA-002A provides analogue interfacing and GPIOs and fiber-connected switches or switch cascades can be used to cover long distances.

Bolero is available in a DECT version and in the new 2.4 GHz version. A high-clarity voice codec provides both higher speech intelligibility and more efficient use of RF spectrum supporting twice the number of beltpacks per antenna for the same radio bandwidth as other systems. The Riedel-exclusive ADR technology combines a unique receiver design with multiple diversity elements specifically designed to reduce sensitivity to multipath reflections, making Bolero DECT and 2.4 GHz useable in challenging RF environments where other systems have great difficulty.

The beltpack itself features six intercom channels and a separate “Reply” button for a quick reply to the last caller. Bolero’s sunlight readable and dimmable display can be rotated so that it is readable in any orientation. Also, in an industry first, the beltpack can be used without a headset like a walkie-talkie radio utilizing an integrated mic and speaker. Bolero DECT beltpacks support Bluetooth, allowing either a Bluetooth headset or a Smartphone to be connected. When a Smartphone is connected, the beltpack can act like a car’s “hands free” setup so the user can receive calls on their phone and talk and listen via their beltpack headset. Users can also inject phone calls directly into the intercom channels, providing new levels of workflow flexibility.

Based on Riedel’s extensive rental experience, the beltpack uses a combination of premium materials, including high-impact plastics and rubber overmolds, making it both tough and comfortable to use in any situation.

BOLERO – Key Benefits

- » Up to 10 beltpacks per antenna
- » Up to 250 beltpacks per Bolero Net
- » Best-in-class voice clarity
- » “Touch&Go” beltpack registration
- » 6-channel beltpack plus dedicated REPLY button
- » Built-in microphone and speaker for Walkie-Talkie mode
- » Smartphone integration via Bluetooth
- » Ergonomic, robust beltpack design
- » Sunlight-readable display with Gorilla Glass™
- » Decentralized AES67 IP networked antennas
- » Seamless integration into Riedel’s Artist intercom matrix



reddot award 2019 winner

Riedel-exclusive ADR technology overcomes multipath issues

Modern, high-clarity voice codec increases beltpack to antenna density

Fully integrated with Artist for point-to-point comms and ease of use

Next generation, digital, global license free, 1.9GHz DECT band

Integrated Bluetooth technology for wireless headsets or phone connection (DECT version only)

IP-65 environmental sealing

Bottle opener – just in case!

NEW 2.4GHz version available.

Up to six full-duplex keys plus convenient REPLY button to last caller

Integrated mic and speaker for headset-free operation

Can be used as a beltpack, a portable desktop keypanel, or walkie-talkie

NFC means no registration headaches! Touch the beltpack to the antenna or beltpack and GO!

Tough, ergonomic beltpack built to survive

BOLERO Accessories



Meet the growing Bolero Family: color-coded beltpack covers, rack mount kits and protection kits further enhance Bolero systems.



BL-BPK-COVER



BL-EPS-1005-00



BL-CHG-1005-R



SPK-001 Stagebox Protection Kit



BL-RMK-1002 -01



RMK-001 Stagebox Rack Mount Kit

Beltpack	Bolero 6-key beltpack
Beltpack Product Code	DECT: BL-BPK-1006-19 2.4GHz: BL-BPK-1006-24
Multi-path delay spread protection	Yes, ADR (Advanced DECT Receiver)
Audio bandwidth	200 Hz to 7 KHz (-3dB)
Mode of operation	Full-duplex on all routes
Encryption	AES256 Bit encryption
Line in	3.5 mm jack, 40 Hz ... 20 kHz, max. +12 dBu input level (local audio mix only)
Talk controls	4 pushbuttons + reply key + 2 walkie-talkie keys (PTT, latching & auto mode)
Volume / level controls	2x rotaries + menu navigation
Display	High contrast sunlight readable full colour TFT display
Audio prompts	Out of range, Bluetooth connected / disconnected, battery low, volume change, Beltpack registered / deregistered / not connected
No. of full-duplex audio paths	6 with individual level control
Handheld operation	Walkie-talkie mode
Vibrate module	Programmable vibrate indicates incoming calls and other notifications
Internal loudspeaker	Freq. <500Hz to >7kHz 80dB/SPL/0.5W/1m, @ <5% THD.
Remote health monitoring	Battery charge status, via web browser
Battery	Lithium Ion removeable battery pack with user removeable clip
USB charging	USB Type C connector for beltpack charging
Operation time	17 hours typical
Headset connector	4-pin male XLR, user replaceable
Microphone type	Electret (ca. 5V bias voltage) or dynamic, user selectable or automatic
Side-tone and microphone gain	Individually adjustable for each beltpack & via remote control
Bluetooth (DECT Version only)	V4.1 (HFP - hands free profile, HSP - headset profile, A2DP - streaming profile) Bluetooth is not supported for 2.4G-Beltpacks.
Bluetooth phone call mix into intercom	Yes
Lanyard anchor points	Yes
Environmental	IP-65 environmental sealing; protected against dust ingress and water spray from all angles (with XLR connector plugged in)
Storage temperature	-20° ... 50 °C long term; -20° ... 60 °C short term
Operational temperature	-10 to +40°C (device operating up to 55°C)
Humidity	0-90%, non-condensing Ta=40°C
Dimensions	(W) 86mm, (D) 48mm, (H) 130mm (W) 3.4", (D) 1.9", (H) 5.1"
Weight	420g inc. battery and clip

Battery Charger	5-bay drop in charger (BL-CHG-1005-R)
No of beltpack slots	5
Beltpack charge time	up to 3 hours
Charge status LEDs	1 per charge slot
Beltpack display	% charged, charging time remaining, temperature, battery health
USB Type A +C	For firmware update and charging a Phone or beltpack via cable
Power socket	1x IEC
Power supply	100-230VAC / 50 - 60 Hz
Mounting	2x wall mounts or 19" rack drawer via optional accessory kit

Antenna	Bolero Active Antenna
Antenna Product Code	DECT: BL-ANT-1010-19 2.4GHz: BL-ANT-1008-24
No of Beltpacks per Antenna	DECT: 10 2.4GHz: 8
Radio frequency range	DECT: 1.880 - 1.930GHz (region dependent) 2.4GHz: 2.403 - 2.479GHz (region dependent)
Antenna radio coverage (diameter)	Indoor (structure dependent): max. ~200; outdoor (free line of sight): ~300-500m
Beltpack to antenna range	Indoor (structure dependent): max. ~200m; outdoor (free line of sight): ~150-250m
Beltpack registration	1 touch NFC registration (beltpack to antenna, and beltpack to beltpack), OTA registration (over the air with PIN)
Network connection	SMPTE 2110 (AES67) IP or direct cable connection in standalone mode
Display type	High contrast E-ink display
Programmable transmission power	yes
Support of Layer 3 networks	yes
TTL Settings	Adjustable multicast TTL (1 to 255 / default 16)
DECT Master Priority	Configurable in WebUI
Network monitoring on antenna display	IP / daisy chain / closed ring
Power supply	PoE+ (802.3at, type 2, class 4, 15 ... 30 W) or 10 ... 57 VDC, 3 A
Power consumption	15W
Mounting points	Mic stand threaded socket 5/8" & 3/8" inside, spigot adapter with wing screw lock, Kensington lock hole, & screw hole for a safety wire mounting
Environmental	P-53 protected against limited dust ingress and water falling as a spray at an angle of up to 60° from vertical
Operational temperature	-10 to 45 °C
Humidity	0-90%, non-condensing Ta=40 °C
Dimensions	210mm (W) x 66mm (D) x 190mm (H); 8.3" (W) x 2.6" (D) x 7.5" (H)
Weight	1320g



NEW
2.4GHz
version available.



Up to 250 beltpacks and 100 antennas per Bolero Net

Intelligent use of bandwidth results in 10 beltpacks per antenna

Decentralized SMPTE 2110-30 (AES67) IP-networked antennas

Fully re-programmable FPGA to handle future networks

Flexible Licensing Scheme

Standalone License

The Bolero Standalone license includes both Standalone Link and Standalone 2110 (AES67) modes, so whether you're looking for a flexible and portable plug & play solution or an IP-based wireless intercom system to ride atop your backbone network, the Standalone license has you covered.

Extended Partylines

By installing the „Extended Partylines“ license, the maximum number of Partylines in a Standalone/Link or Standalone 2110 (AES67) Bolero system can be increased from 12 to 32.

Advanced Monitoring (DECT version only)

Bolero features RF monitoring capabilities that allow users to leverage both antennas and beltpacks to scan or monitor the radio spectrum used by DECT devices. The antenna scanner enables period measurement of time-slot usage and identification of DECT systems in the RF space. At the same time, the Bolero beltpack can be used to monitor the time-slot capacity and audio quality while staying fully operational.

BOLERO Standalone 2110 (AES67)

- » Antenna distribution via SMPTE 2110-30 (AES67) IP network
- » Multiple fiber-connected switch cascades for long distances
- » Analogue 4-wires and GPIOs via optional NSA-002A throwdown box
- » Redundant power option
- » Integrated web browser for configuration (Artist not required)
- » 12 partylines and unlimited point-to-point connections
- » 100 beltpacks, 100 antennas

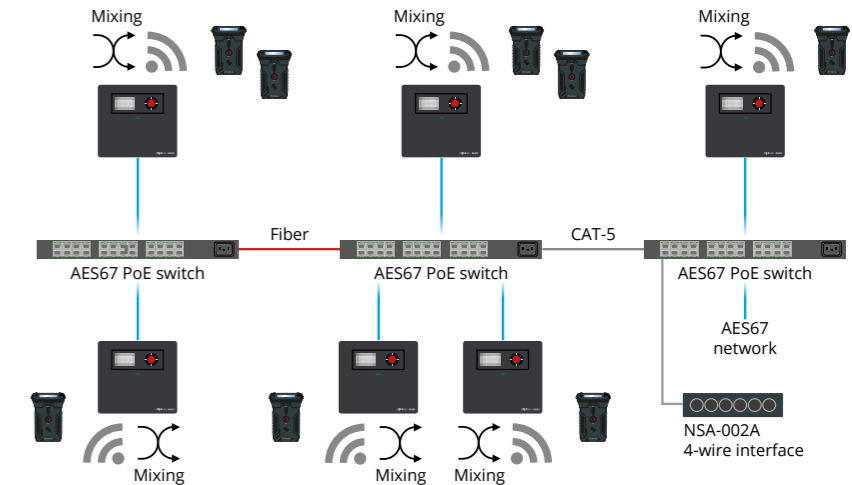

Network Modes

BOLERO Integrated

- » Seamless comms environments with the full power of Artist, including SmartPanels and extensive I/O connectivity
- » Multiple fiber-connected switch cascades for long distances
- » Antenna distribution via SMPTE 2110-30 (AES67) IP network
- » Redundant power supply
- » Extensive connectivity options including SMPTE 2110-30/31 (AES67), AES3, MADI, Dante and analogue 4-wires
- » Configuration via Director, Artist's powerful configuration tool
- » 500 conferences and unlimited point-to-point connections
- » 250 beltpacks, 100 antennas

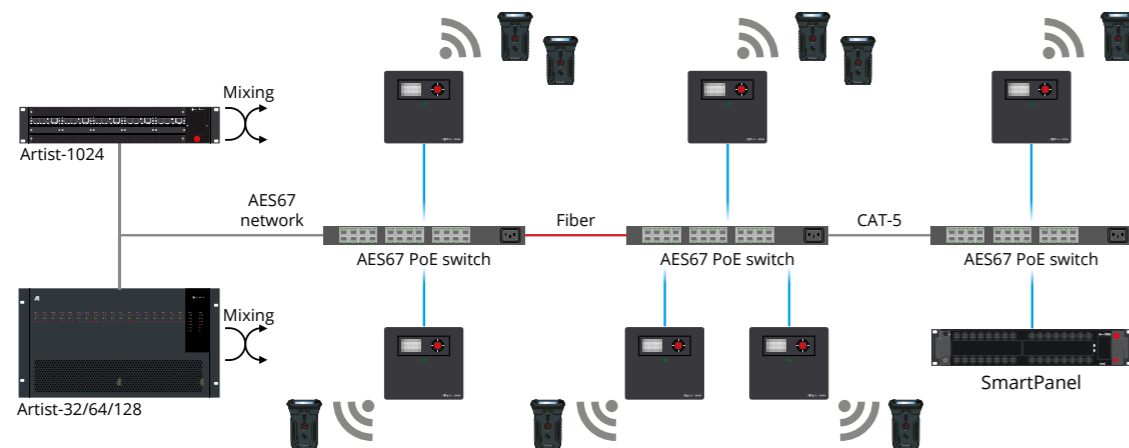

BOLERO Standalone Link

- » Daisy chain or redundant ring antenna network
- » Plug&Play simplicity
- » EPS-1005 PSU powers up to five antennas
- » Redundant power option
- » Up to 300m CAT5 cable between antennas
- » Analogue 4-wires and GPIOs via optional NSA-002A throwdown box
- » Integrated web browser for configuration (Artist not required)
- » Up to 32 partylines and unlimited point-to-point connections
- » 100 beltpacks, 100 antennas

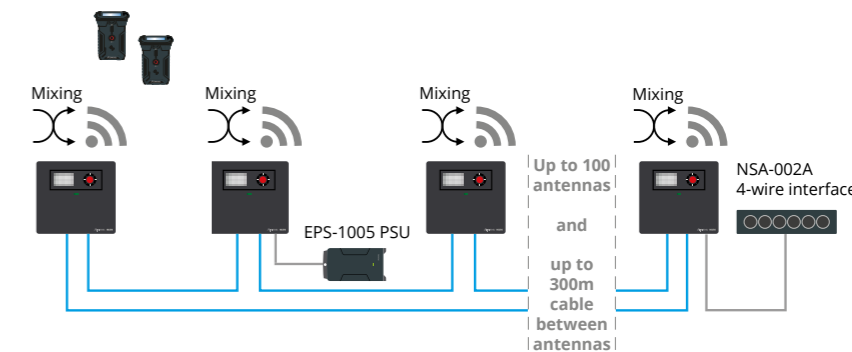

INTERCOM
ACCESSORIES

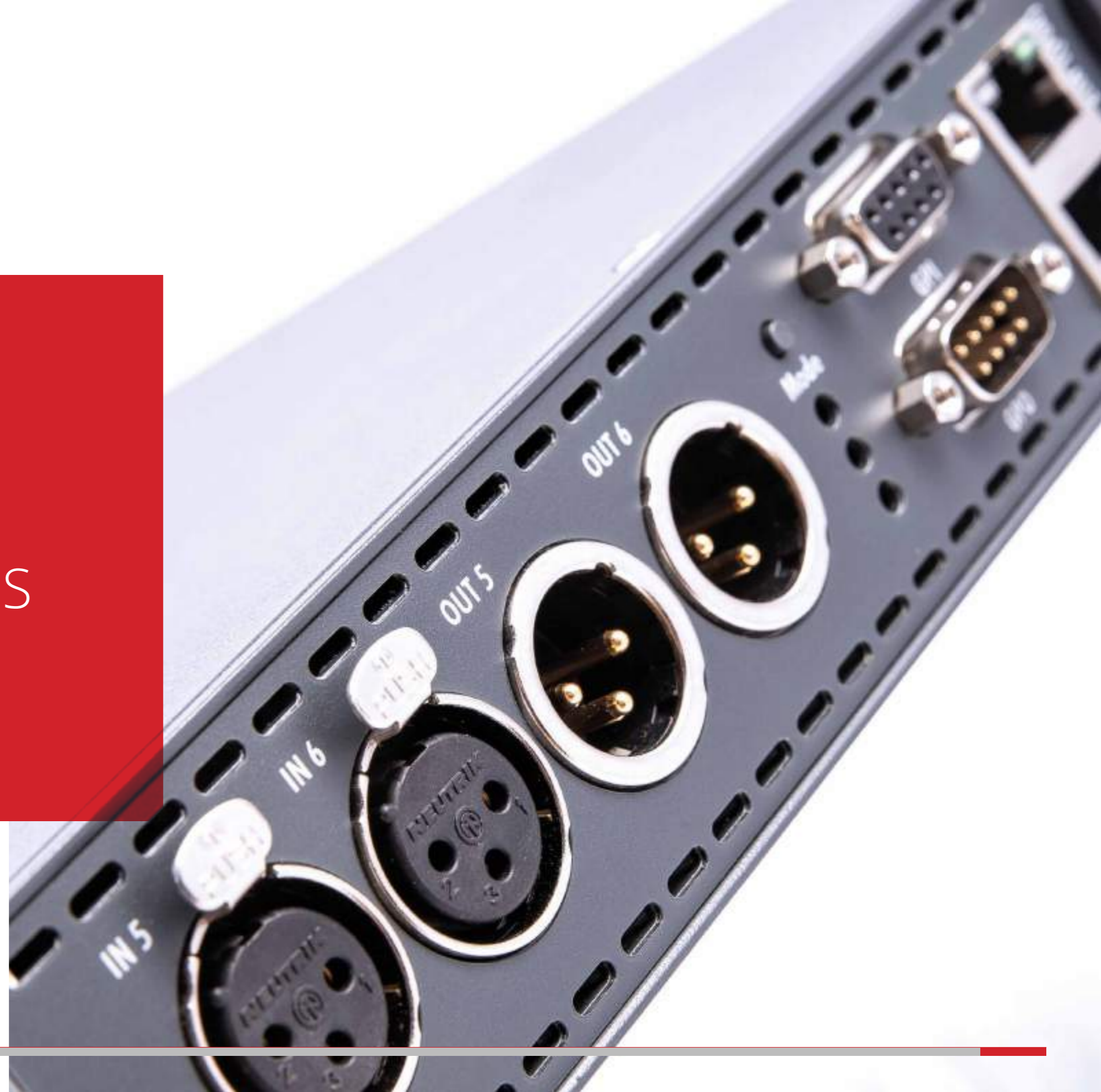

Network Interfacing

Intelligent and seamless interfacing to the outside world is the key to success in many intercom applications. The Artist platform is an open world of communications. Dedicated interface solutions let you communicate with telephones, digital and analog partylines, camera intercoms, 2-way radios and other analog and digital systems.



Connect Trio

ConnectTrio combines the following in one half-rack/1RU device: two independent analog POTS telephone hybrids; an ISDN BRI/S₀ interface with two independent ISDN B-channels; and two independent VoIP audio codecs. This not only saves rackspace and eliminates the need for additional equipment, but also provides enhanced flexibility to the intercom installation. Connect Trio enables you to dial, make and receive calls to and from any PSTN, VoIP, ISDN or mobile phone as well as G.722 reporter codecs. When used with Artist and Tango intercom systems, you can even remote key panels via ISDN.



Connect IPx8

Connect IPx8 provides high-quality audio-over-IP interfacing for intercom systems (EBU Tech 3347 compatible). The 19"1RU unit is designed to connect up to eight Artist control panels or audio lines to the Artist VOIP-108 G2 matrix client card via IP based networks. The SIP-based interface converts AES3 or analog signals into compressed IP data and vice versa. Connect IPx8 can be configured to meet your individual bandwidth needs, always providing an unmatched combination of audio quality and low network traffic. The panel interface flawlessly connects any Riedel 1100, 1000, 2300 or 5108 series key panel with full functionality to Artist and Tango matrices via IP-networks.



Connect IPx2

Connect IPx2 is the little brother to the Riedel Connect IPx8 panel interface. The ¼ 19"1RU unit is designed to connect up to two Riedel key panels to Artist and Tango matrices via IP based networks.

Network Stream Adapters



NSA-002A

Riedel's NSA-002A Network Stream Adapter handles all bi-directional signal conversion between analog signals and AES67. The NSA-002A is a plug-and-play device that has multiple mounting options and connects between a Bolero wireless intercom system and any analog 4-wire.

Power is provided internally or via PoE and convenient LEDs indicate system status.

Partyline Interfacing



Performer C44plus system Interface

The C44plus System Interface seamlessly integrates digital partylines in matrix intercom environments and can also serve as a stand-alone matrix for small applications. The plus-version features a USB-port on the front to connect a PC to configure the internal 24x24 matrix via the Performer AAS Audio Assignment Software.



Performer C22 system Interface

The Performer C22 system interface converts two two-channel CAT5 matrix ports to two phantom powered digital beltpack lines and vice versa, allowing for the seamless integration of digital partylines with matrix intercom systems. In addition, it can also be used for any application that necessitates the routing of digital partyline intercom audio via an AES digital audio infrastructure such as with MediorNet, Artist or any 3rd party AES audio router solution.

Radio Interfacing



RiFace G2 – Universal Radio Interface

The RiFace G2 is a universal radio interface to connect wired communication systems with walkie-talkie style radio systems. The 19"2RU interface includes one or two two-way radios (user provided), processor logic to control the radios, DSP-presets as well as circuitry to adjust the levels of the various audio sources. Set-up and operation is fast and easy. The RiFace G2 can also operate as a stand-alone radio repeater.



JUGGLER – TETRA Radio Interface

The Riedel JUGGLER solution seamlessly integrates TETRA digital trunked radio networks into the wired intercom matrix, providing intelligent integration between TETRA radio groups and Riedel Artist intercom ports. The system allows calls from any port/group/conference of the Artist system to up to 64 individual TETRA radio groups and vice versa. The interface connects the TETRA Base Station Controller to any given Riedel Artist system via MADI. JUGGLER works with any TETRA-standard compliant subscriber.

JUGGLER – System Overview

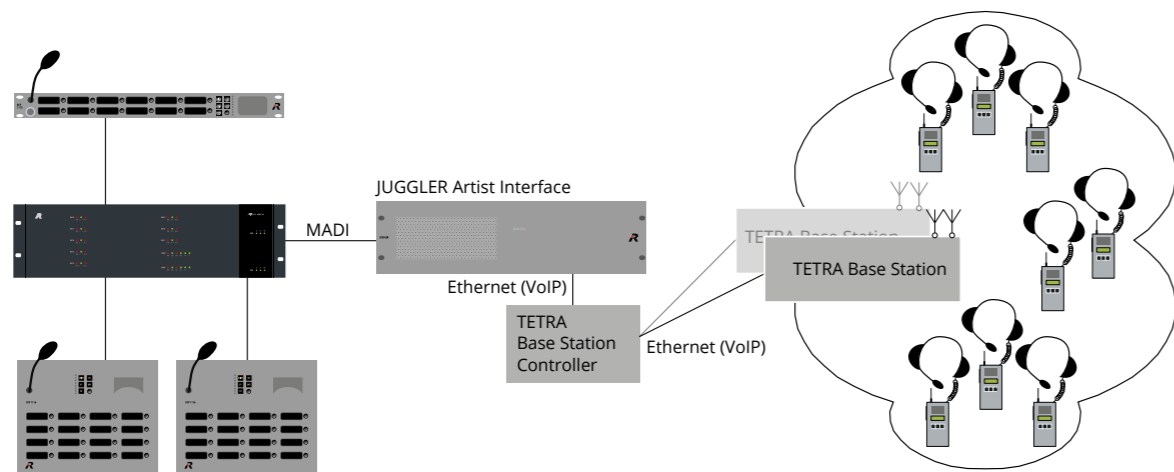

ACTOR – System Overview

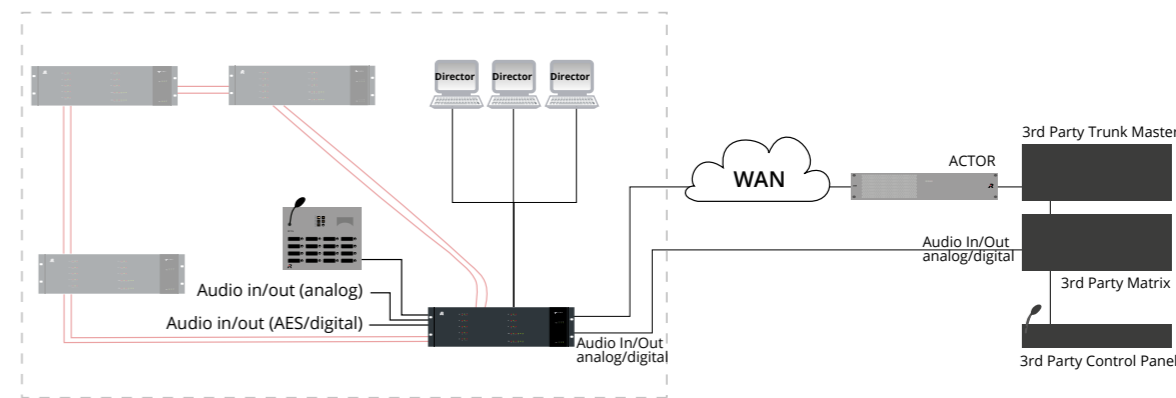

CONNECT IPx2 / IPx8 – System Overview

- Applications:
- 1 multi-port matrix-to-matrix connections (Trunking)
 - 2 matrix-to-control panel connections
 - 3 multi-channel distribution of audio lines
 - 4 matrix-to-virtual control panel connections

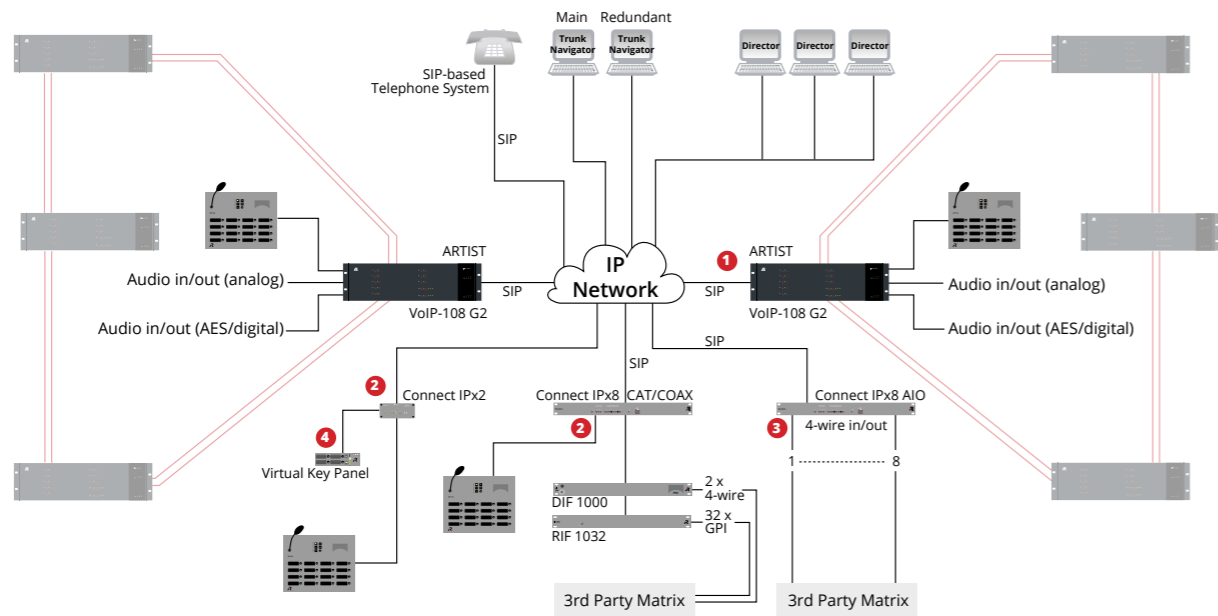

CONNECT TRIO – System Overview

- Applications:
- 1 dual analog POTS hybrid
 - 2 ISDN BRI interface (2x ISDN B-channel)
 - 3 2x VoIP channels

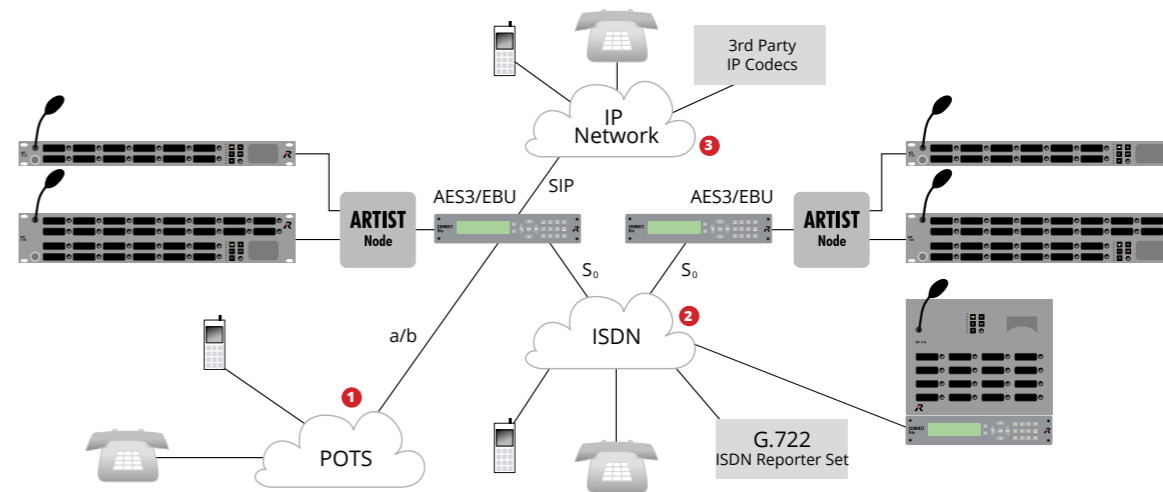

HEADSETS



Comfortably functional... Headsets for Intercom & Radio Applications

As an intercom technology specialist, Riedel perfectly understands the specific demands and requirements of customers for intercom headsets. Headsets should be durable, light weight, small, comfortable and easy to clean and to maintain. All Riedel intercom headsets combine optimal audio quality with absolute reliability and are compatible with radios, belt packs and intercom control panels from other manufacturers.

TAC – Professional In-Ear Headset

The TAC is an ultra-lightweight one-ear headset optimized for the use with Riedel's Bolero wireless intercom system for demanding applications where a secure fit is required. The headset has a flexible microphone boom that can be attached to clothing with a clip to perfectly position and adjust the microphone to the wearing needs of the user. With the flexible mic and earpiece you can easily disguise the cable under your clothes. It can be used with custom earmolds for a perfect individual fit.



RUN – Professional In-Ear Headset

Optimized for use with Riedel's award-winning Bolero wireless intercom system, the RUN Series is an ultra-lightweight one-ear headset for demanding, high-noise environments. Therefore they are a perfect match for environments like sports, security or live events. The adjustable mic boom and the ability to be used with custom earmolds enable for a perfect individual fit.



AIR – Ultra Light Professional Headset

The Riedel AIR series is the ideal ultra lightweight headset for customers who place great demands on quality, design and comfort. The AIR headset allows you to communicate with your immediate environment while simultaneously speaking and listening via your headset. The specially engineered Coolmax® material used for the exchangeable ear cushions provide great breathability and comfort for long hours. The 270° rotation of the microphone boom allows the microphone to be worn on either left or right side, and a noise compensating electret or dynamic microphone guarantees a high quality response.



Coolmax® is a registered trademark of INVISTA



PRO – Closed Professional Headset

The Riedel PRO series provides reliable, high-quality professional headsets that were designed in conjunction with beyerdynamic® to meet the demanding requirements of digital intercom applications. The headphone features a neodymium magnet system for accurate reproduction and balanced sound. The soft circumaural earcups provide very good noise attenuation and are as comfortable as the fully adjustable padded headband. The headset provides either a hypercardioid dynamic microphone or a high-quality omnidirectional condenser microphone for commentary applications. The 270° rotation of the microphone boom allows the microphone to be worn on either left or right side.



MAX – High Performance Headset

The MAX series headsets have been specially designed for use in areas with high ambient noise levels. The headsets feature excellent attenuation abilities and therefore provides optimal hearing protection for their users. The special noise cancelling electret or dynamic microphone guarantees clear communications in all conditions. This makes Riedel's MAX headset the ideal choice for sound & light crews or TV camera intercom in sports or concert venues. The MAX offers high comfort and low weight. The soft headset cushions are easily detachable for quick exchange. The microphone boom rotates 270° and allows the microphone to be worn either on the lefthand or right-hand side.

Symbols

- 1 2** single headphone / dual headphones
- D E** dynamic microphone / electret microphone
- omnidirectional condenser microphone for commentary applications
- excellent noise attenuation for high-noise environments
- 270°** microphone boom rotates 270° allowing for either left or right sided mic/headphone
- exchangeable components for easy maintenance

Accessories

For all of our headsets series Riedel offers a wide range of accessories and spare parts.

Connectors and Cables

All headsets are available with 4-pin XLR female as standard. As an option we offer our stereo headsets with a 7-pin XLR female connector. The standard cable length is 1.5 meters, but there are extra-long versions in the portfolio. Please reach out to our sales team for more information.

Specifications

TAC Headset

Speaker	TAC (E1L/E1R)
Frequency response	200 – 5kHz ±6dB
Impedance	395 Ω at 500Hz
Characteristic SPL	100dB ±3dB
T.H.D.	<5%

Microphone	
Transducer type	Electret
Polar pattern	Omnidirectional
Frequency response	20 – 20.000 Hz
Impedance	<2.2 Ω
Operating Voltage	1.5 - 3 V (max. 10V)
Sensitivity	-38 +3 dB
Operation Temperature	-10 →+70°C
Storage Temperature	-20 →+60°C

RUN Headset

Speaker	RUN (E1L/ E1R)
Frequency response	200 – 5kHz ±6dB
Impedance	395 Ω @ 500Hz
Characteristic SPL	100dB ±3dB
T.H.D.	<5%

Microphone	
Transducer type	Electret
Polar pattern	Omnidirectional
Frequency response	100 – 10kHz
Impedance	<2.2K Ω
Operating Voltage	3.0 - 10 VDC
Sensitivity	-3 dB @ 1.5V
Max. Input SPL	110 dB / THD < 3%

AIR Headset

Speaker	AIR (D1/D2)	AIR (E1/E2)
Frequency response	100 Hz – 18 kHz	100 Hz – 18 kHz
Impedance (XLR4F version)	150 Ω 1 mW/1 kHz	150 Ω 1 mW/1 kHz
Characteristic SPL	91 dB 1 mW/1 kHz	91 dB 1 mW/1 kHz

Microphone		
Transducer type	NC Dynamic	NC Electret
Polar pattern	Hypercardioid	Bi-Directional
Frequency response	150 Hz – 10 kHz	150 Hz – 15 kHz
Nominal Impedance	200 Ω	>1600 Ω
Supply power	---	4.5 V 400 µA

PRO Headset

Speaker	PRO (D1/D2)
Frequency response	10 Hz – 30 kHz
Impedance (XLR4F version)	250 Ω
Characteristic SPL	100 dB at 1 mW / 1 kHz

Microphone	
Transducer type	Dynamic
Polar pattern	Hypercardioid
Frequency response	40 Hz – 12 kHz
Nominal impedance	200 Ω
Supply power	-

MAX Headset

Noise Attenuation	125	250	500	1,000	2,000	4,000	8,000
Attenuation (EN 24869-1) / dB	14	19	26	31	28	34	34

Speaker	MAX (D1/D2)	MAX (E1/E2)
Frequency response	80 Hz – 20 kHz	80 Hz – 20 kHz
Impedance (XLR4F version)	300 Ω	300 Ω
Characteristic SPL	94 dB at 1 mW / 1 kHz	94 dB at 1 mW / 1 kHz

Microphone		
Transducer type	Dynamic	Back electret
Polar pattern	Hypercardioid	Bidirectional noise cancelling, pressure gradient type
Frequency response	40 Hz – 12 kHz	150 Hz – 5 kHz
Nominal impedance	200 Ω	2.2 kΩ
Supply power	---	4.5 V 170 µA

The MAX headset has been designed for the special communications needs in motor sports such as Formula One. In this environment, the crews at the pitwalls need to communicate under high ambient sound pressure levels.

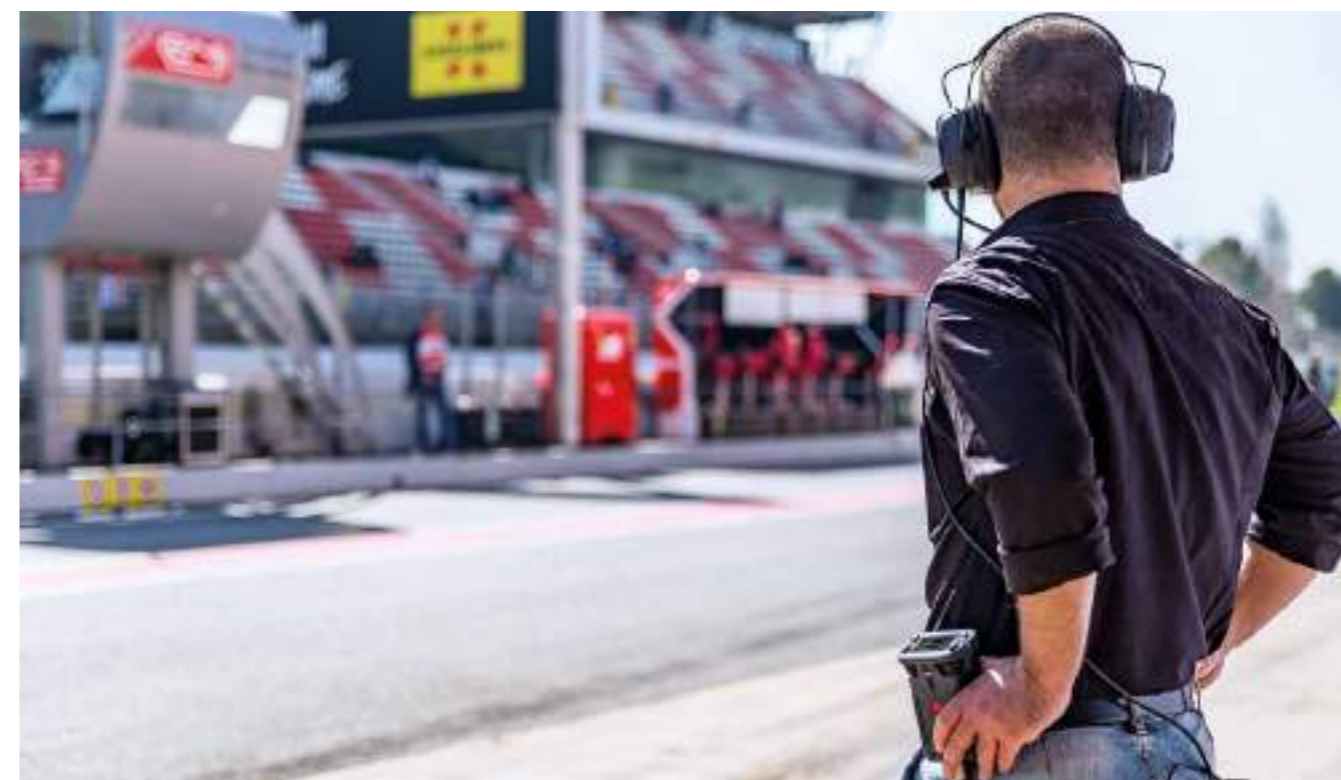

SERVICES

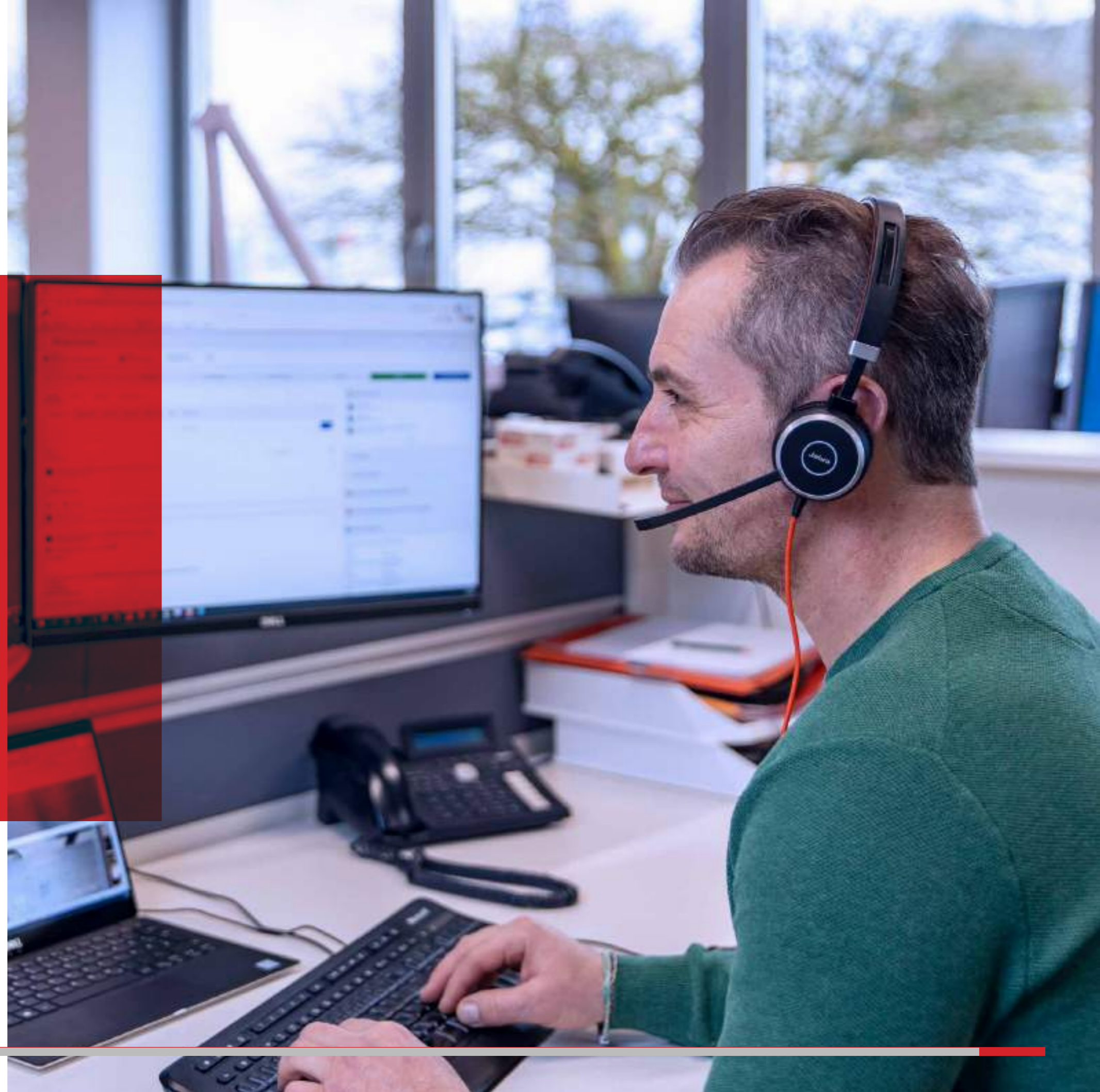

Riedel Services

Design & Set-up – Maintenance – Support

We see ourselves as your partner in designing, setting-up, operating, and maintaining your Riedel products and solutions in the best possible way.

Do you work around the globe?
Do you work around the clock?
Do you have a big installation?
Do you have a small installation?

Whatever the case, uptime is crucial for your business.

Riedel's worldwide network of partners and offices, along with our headquarters in Wuppertal, offer a variety of services that are tailored to match your needs.

Explore the possibilities in the following pages.

Consulting

Are you unsure as to what you are looking for or wonder which products will best fit your workflow? No Problem!

Together with our sales managers, a dedicated global team of consultants are available to assist you through the process of system design. Our team is ready help you devise, develop, fine-tune, and implement strategic, cutting-edge solutions that meet and exceed your workflow requirements.

With consulting, we offer comprehensive scenario and workflow simulations and assistance with the design demonstration and realization of challenging technical integrations.

Our consultants pride themselves in assisting customers from project inception to completion and are available to work with you at any of our offices or on your premises.

Commissioning

It is important to ensure your product and system performance before you go live.

Our team of experienced consultants, engineers and technicians will ensure that your system has up-to-date software and firmware and will help you with basic configurations as planned in the consulting phase.

Commissioning can be done at our facility (Factory Acceptance Test), at your facility (Site Acceptance Test), or as a service without any formal acceptance.

Riedel Academy

The more you know about our products, the better you can operate them and the more benefit they will deliver for you – Knowledge is key!

Riedel Tuesdays

You can get a hands-on introduction to Artist by joining us at a Riedel Tuesday. Hosted in our regional offices around the world the goal is to provide you with information about our products in an informal and casual setting. At these events you can meet other people from the industry and learn what's new from Riedel.

Online Seminars and Workshops

Join one of our online sessions, taking place throughout the year from the comfort of your own home or office. Online sessions are for users who want to build up mouse-on experience on specific products. Workshops take place in small groups of up to eight people where we offer a mix of product overview, hardware and software familiarization, and hands-on programming & configuration. These sessions are free-of-charge and can be booked directly from our events page: <https://riedel.events.idloom.com>.

Customized Training

Of course, we also offer training tailored specifically to your needs. These can be held at one of our subsidiaries or at your facility on your system. These sessions will allow your system administrators, service, and maintenance engineers to learn and implement best practices from our experienced trainers.

In case your system is already up and running and you want to refresh your staff on our products or train new staff, we can also provide dedicated equipment for the training.

Don't yet have a system? No problem!

We can also provide in-person training in our Riedel Media Studio - a fully-functional production studio where you can gain real-life experience in a practical setting and discover how to remove the stress from your workflows. These tailored sessions can be arranged through your account manager and take place in our HQ in Wuppertal, Germany.

Contact us via training@riedel.net

Dates and locations are published at

www.riedel.net/en/services/academy



Riedel Care

Riedel Care gives you peace of mind when it comes to support for your systems. A worldwide team of experts provides support via telephone, e-mail, remotely or in person to help you get the maximum performance out of your Riedel solutions and products over their lifetime. With all current products on hand, our engineers can reproduce issues and find solutions quickly.

To adapt perfectly to your business model, we offer two options as a standard. Riedel Care Max offers 24/7 first and second level support, included on-site support days, repair loaners on request and software updates. Where 24/7 is not needed, Riedel Care is the product of choice offering support Mon-Sun 8am-5pm local*.



	Riedel Care	Riedel Care Max
Hotline	Mon-Sun 8 am - 5 pm local*	24/7
Remote Support	Included	Included
Included On-Site Support days Excluding travel expenses	Depending on system size	Depending on system size
Additional On-site support days	20% discount on list price	30% discount on list price
Repair loaners	Dispatch within two business days	Dispatch within one business day
Discount on repairs	20%	30%
Software updates, bug fixes, patches	Included	Included

*assigned to one of the following time zones: Pacific Standard Time, Central European Time, Australian Eastern Standard time depending of the system location

Hotline

Mon-Sun 24/7, 365 days access to Riedel's own worldwide support staff for critical issues. We can receive calls and e-mails in English from any caller at your facility. Other languages are available on a case-by-case basis. As far as it is possible, the assigned Riedel engineer will remain the point of contact through the entire case. Non-technical requests are ideally addressed to either your regional sales manager, your regional Riedel subsidiary or to the Riedel headquarters. For contact details please see www.riedel.net/en/contact/

On-site Support Days

Riedel's second level support engineers are available to visit your facility for advanced trouble shooting after the system has been commissioned. The number of included on-site support days depend on the installed size of the system. Additional on-site support days can be offered in advance or ordered on a case-by-case basis. They will be discounted against list price depending on the grade of your Riedel Care package. Additional on-site services such as design or planning services, commissioning, technical product trainings can be ordered at any time and will be offered as a separate service.

E-mail Support

E-mail support is given in addition to the support via telephone. Our case management system ensures prioritization within the Riedel group.

Spare Parts

We hold an extensive stock of spare parts for current products as shown on the Riedel website. This covers complete devices, single PCBAs and components.

Distributed Service & Support

Our global team of support engineers coupled with our decentralized stock of spare parts and hardware for repair loaners ensure your continuous operation.

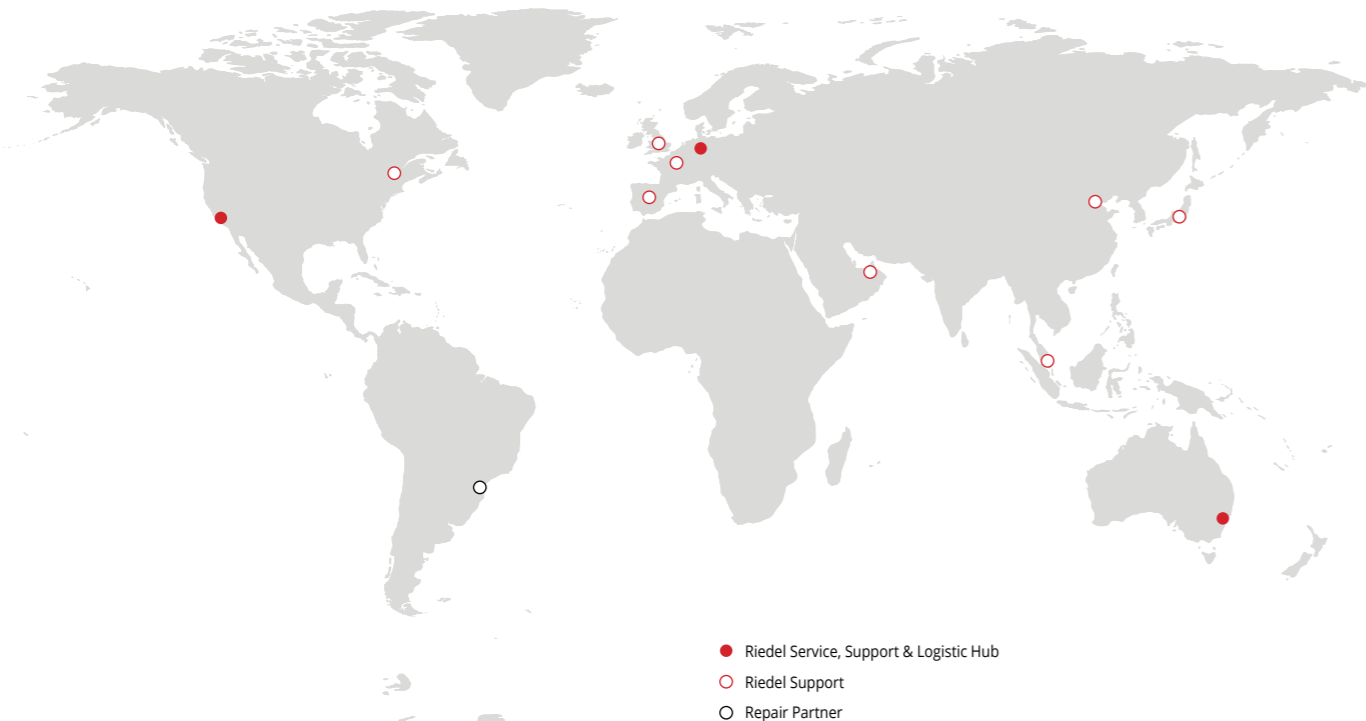

Repair Loaner

In case Riedel's technical support team has confirmed a hardware issue with a device, a repair loaner can be sent on your request for the time of the repair. This ensures operation while waiting for the repair. Repair loaners are available for standard pricelist products. They are dispatched free of charge from our nearest logistics hub to the address specified in the Contract Data.

Our logistic hubs are located across the world:

- » Europe/Middle East: Germany, Wuppertal Office
- » North America: USA, California, Los Angeles Office
- » Asia-Pacific: Australia, Sydney Office
- » Riedel Care: Dispatch within two business days
- » Riedel Care Max: Dispatch within one business day

Repairs

Costs for repairs are discounted when covered by Riedel Care. To better manage operational costs for repairs, our standard manufacturer's warranty can be extended by purchasing an Extended Warranty program.

An RMA (Return Material Authorization) number is not mandatory but available to return defective devices to Riedel.

Repairs can be carried out for current products and in most cases for seven years after a product has been set to end of life (removed from our website, catalogue and pricelist).

Even after that period, we can repair on a best effort basis in most of the cases.

Remote Support

With remote support, Riedel offers direct access to your system for online diagnostics. Using your local PC running our configuration software, we can view your system and help to fix configuration issues or explain error messages expediting the trouble shooting capabilities.

Software Updates

To keep your system up to date, we offer software updates with bug-fixes and patches multiple times per year on various products. All current versions are listed at our website for your quick reference:

www.riedel.net/en/downloads/firmware-software/

On request, we will provide you with the most recent software files and guide you through the update, if needed we can support remotely. Typically, we support the current release and the one before.

Software Upgrades

Software upgrades are defined as an upgrade to another edition of a Software. Software upgrades are typically listed in the Riedel sales pricelist and they are a chargeable line item.

Warranty & Extended Warranty

Riedel products come with a two years standard manufacturer warranty. This can be extended by purchasing our Extended Warranty program for another one, two or three years to a total of up to five years.

Extended Warranty is not included in Riedel Care or Riedel Care Max, but can be purchased node locked for a device at the moment of sale.

See our detailed description for extended warranty and eligible products at <https://www.riedel.net/en/services/warranty/>.



Overview of Services and Support

	Riedel Care	Riedel Care Max	Comment
Support hours	Mon-Sun 8am - 5pm local ¹⁾	24/7	-
First Level Support²⁾	Included	Included	-
Second Level Support³⁾	Included	Included	-
Hotline	Prioritized	Prioritized	-
E-mail support	Prioritized	Prioritized	-
Support per remote	Included	Included	Using TeamViewer
Included on-site support days	Included	Included	The number of days depends on the size of the system. Travel cost and expenses not included.
Travel expenses and cost for accommodation	Not included	Not included	Payable as incurred
Discount on additional support days	20%	30%	Not applicable on travel cost and expenses
Repair loaners	Included	Included	Available for standard price list items
Dispatch of repair loaners	Within two business days	Within one business day	From nearest logistic hub. Add transit time.
Freight cost for shipping of loaners	Included	Included	-
Repairs	Payable service	Payable service	-
Discount on repairs	20%	30%	Discount applies to spare parts and labor value
Time to repair	Prioritized	Prioritized	-
Access to spare parts	Yes	Yes	-
Software update files	Included	Included	Including bugfixes and minor updates
Remote support during software update	Included	Included	Must be planned in advance
Software upgrade files	Payable service	Payable service	Higher edition of software
Remote Support during software upgrade	Included	Included	Must be planned in advance
Emergency response time	1 hour	30 minutes	-
Design / planning	Free of charge	Free of charge	Limited to overview planning and design. No detailed wiring diagrams, rack views
Installation of devices, cables	Not included	Not included	-
Installation of operation systems (OS) and support of third party IT systems	Not included	Not included	Can be ordered on a case by case basis
Commissioning Per remote or on-site	Payable service	Payable service	-
Technical training Per remote or on-site	Payable service	Payable service	-
Go live support Per remote or on-site	Payable service	Payable service	-

¹⁾ **Local**
Assigned to one of the following time zones: Pacific Standard Time, Central European Time, Australian Eastern Standard time, depending on the system location.

²⁾ **First Level Support**
Our First Level Support team is your first point of contact. In First Level Support we receive your request, fill in all needed information and document it in our system. We will analyse the underlying problem and classify the request. Basic requests such as request for documentation, standard usage problems (e.g. on the physical layer) and basic configuration questions will be solved immediately using standard procedures and providing known solutions. More complex issues will be handed over to our Second Level Support Team.

³⁾ **Second Level Support**
Our Second Level Support covers complex inquiries and includes e-mail, telephone and remote support, log file analysis and reproduction of issues in a Riedel lab, if necessary.

Questions?

We are happy to answer all of your questions and tailor a service that fits your needs.

Contact your local Riedel office for more information.

Windows is a registered trademark of Microsoft Corporation. Mac OS X is a registered trademark of Apple Inc. MOTOROLA and MOTOTRBO are registered trademarks of Motorola Inc., TELEX and RTS are registered trademarks of Bosch Security Systems. All trademarks are the property of their respective owners. Product specifications are subject to change without notice. This material is provided for information purposes only; Riedel assumes no liability related to its use.



Riedel Communications GmbH & Co. KG
Uellendahler Str. 353 | 42109 Wuppertal | Germany
Phone +49 (0) 202 292-90 | info@riedel.net | www.riedel.net

#09/2023