

*KP-3016 Keypanel  
KP-3016A Keypanel  
and  
EKP-3016 Keypanel  
Technical Manual*

*up to and including version 1.1.0*



*KP-3016*



*KP-3016A*



*EKP-3016*

**PROPRIETARY NOTICE**

The product information and design disclosed herein were originated by and are the property of Bosch Security Systems, Inc. Bosch reserves all patent, proprietary design, manufacturing, reproduction, use and sales rights thereto, and to any article disclosed therein, except to the extent rights are expressly granted to others.

**COPYRIGHT NOTICE**

Copyright 2016 by Bosch Security Systems, Inc. All rights reserved. Reproduction, in whole or in part, without prior written permission from Bosch is prohibited.

\*All other trademarks are property of their respective owners.

**WARRANTY AND SERVICE INFORMATION**

For warranty and service information, refer to the appropriate web site below:

- RTS Intercoms ..... [www.rtsintercoms.com/warranty](http://www.rtsintercoms.com/warranty)
- RTS Digital
- RTSTW
- AudioCom
- RadioCom
- Intercom Headsets ..... [www.telex.com](http://www.telex.com)

**CUSTOMER SUPPORT**

Technical questions should be directed to:

- Customer Service Department
- Bosch Security Systems, Inc.
- [www.telex.com](http://www.telex.com)



**TECHNICAL QUESTIONS EMEA**

Bosch Security Systems Technical Support EMEA

[http://www.rtsintercoms.com/contact\\_main.php](http://www.rtsintercoms.com/contact_main.php)

**DISCLAIMER**

The manufacturer of the equipment described herein makes no expressed or implied warranty with respect to anything contained in this manual and shall not be held liable for any implied warranties of fitness for a particular application or for any indirect, special, or consequential damages. The information contained herein is subject to change without prior notice and shall not be construed as an expressed or implied commitment on the part of the manufacturer.

	<p><b>CAUTION</b></p> <p>RISK OF ELECTRIC SHOCK DO NOT OPEN</p>	
<p>THE LIGHTNING FLASH AND ARROWHEAD WITHIN THE TRIANGLE IS A WARNING SIGN ALERTING YOU OF "DANGEROUS VOLTAGE" INSIDE THE PRODUCT.</p>	<p>CAUTION: TO REDUCE THE RISK OF ELECTRIC SHOCK, DO NOT REMOVE COVER. NO USER-SERVICABLE PARTS INSIDE. REFER SERVICING TO QUALIFIED SERVICE PERSONNEL.</p>	<p>THE EXCLAMATION POINT WITHIN THE TRIANGLE IS A WARNING SIGN ALERTING YOU OF IMPORTANT INSTRUCTIONS ACCOMPANYING THE PRODUCT.</p>
<p>SEE MARKING ON BOTTOM/BACK OF PRODUCT.</p>		

**WARNING:** APPARATUS SHALL NOT BE EXPOSED TO DRIPPING OR SPLASHING AND NO OBJECTS FILLED WITH LIQUIDS, SUCH AS VASES, SHALL BE PLACED ON THE APPARATUS.

**WARNING:** THE MAIN POWER PLUG MUST REMAIN READILY OPERABLE.

**CAUTION:** TO REDUCE THE RISK OF ELECTRIC SHOCK, GROUNDING OF THE CENTER PIN OF THIS PLUG MUST BE MAINTAINED.

**WARNING:** TO REDUCE THE RISK OF FIRE OR ELECTRIC SHOCK, DO NOT EXPOSE THIS APPRATUS TO RAIN OR MOISTURE.

**WARNING:** TO PREVENT INJURY, THIS APPARATUS MUST BE SECURELY ATTACHED TO THE FLOOR/WALL/RACK IN ACCORDANCE WITH THE INSTALLATION INSTRUCTIONS.

	<p>This product is AC only.</p>
---	---------------------------------

	
---	--

---

## *Important Safety Instructions*

1. Read these instructions.
2. Keep these instructions.
3. Heed all warnings.
4. Follow all instructions.
5. Do not use this apparatus near water.
6. Clean only with dry cloth.
7. Do not block any ventilation openings. Install in accordance with the manufacturer's instructions.
8. Do not install near any heat sources such as radiators, heat registers, stoves, or other apparatus (including amplifiers) that produce heat.
9. Do not defeat the safety purpose of the polarized or grounding-type plug. A polarized plug has two blades with one wider than the other. A grounding type plug has two blades and a third grounding prong. The wide blade or the third prong are provided for your safety. If the provided plug does not fit into your outlet, consult an electrician for replacement of the obsolete outlet.
10. Protect the power cord from being walked on or pinched particularly at plugs, convenience receptacles, and the point where they exit from the apparatus.
11. Only use attachments/accessories specified by the manufacturer.
12. Use only with the cart, stand, tripod, bracket, or table specified by the manufacturer, or sold with the apparatus. When a cart is used, use caution when moving the cart/apparatus combination to avoid injury from tip-over.
13. Unplug this apparatus during lightning storms or when unused for long periods of time.
14. Refer all servicing to qualified service personnel. Servicing is required when the apparatus has been damaged in any way, such as power-supply cord or plug is damaged, liquid has been spilled or objects have fallen into the apparatus, the apparatus has been exposed to rain or moisture, does not operate normally, or has been dropped.



---

# Table of Contents

---

<b>INTRODUCTION .....</b>	<b>11</b>
Features .....	11
Specifications .....	12
KP-3016/3016A Block Diagram .....	14
Reference View – KP-3016 .....	15
Connector Pinouts .....	16
<b>INSTALLATION .....</b>	<b>17</b>
Requirements .....	17
KP-3016/KP-3016A Installation .....	18
Connecting the Keypanel .....	19
Power Up .....	21
Address Setting .....	22
Connections .....	23
<b>BASIC OPERATION .....</b>	<b>29</b>
Intercom Keys and Displays .....	29
Keypad Reference View .....	32
INFO button .....	34
Menu Navigation and Shaft Encoder Knobs .....	35
CLR Button .....	35
Basic Intercom Key Operation .....	36
Crosspoint Gain Adjustment .....	37
Keypanel Volume Adjustments .....	38
Aux Volume Adjustments (KP-3016 Only) .....	39
Operation of Intercom Keys with Auto Functions .....	40
Operation of Intercom Keys with Options .....	41
Operation of Intercom Talk Keys with the Speaker DIM Setting .....	41
Call Waiting Operation .....	42
Graphical Call Waiting Window .....	43
Mic Select .....	46
Setup Pages .....	47
Menu Passwords .....	48
Keypanel Color Window .....	49
Enhanced Tallies .....	56
Flash Text Characteristics Window .....	60
Show Icon Characteristics Window .....	62

<b>FIRMWARE DOWNLOAD .....</b>	<b>67</b>
Download Firmware to the KP-3016/3016A From AZedit .....	67
Download Firmware to the Keypanel Using the Firmware Upload Tool .....	69
Download Firmware Using the Bootloader .....	72
Enable Downloading New Bootloader from the Keypanel .....	74
Display the FPGA Version .....	74
Download and Upgrade the FPGA in the KP-3016/3016A .....	74
Download a Splash Screen .....	77
Download a Font File .....	79
Download a Icon File .....	81
 <b>KP-3016/3016A MENU SYSTEM .....</b>	 <b>85</b>
Main Menu Access .....	85
Menu System, Audio Options .....	86
Menu System, Display .....	105
Menu System, Key Assign Menu .....	109
Menu System, Key Options Menu .....	114
Menu System, OMNEO Offers (Only available for KP-3016) .....	120
Menu System, RVON Offers (Only available when an RVON-IO is detected) .....	120
Menu System, Save Config .....	121
Menu System, Service .....	122
 <b>CENTRALIZED AUTO-DIALING .....</b>	 <b>137</b>
Centralized Auto Dials .....	137
Receiving A Phone Call .....	140
Hanging Up .....	140
 <b>KEYPANEL MENU QUICK REFERENCE .....</b>	 <b>141</b>
Audio Options .....	141
Display Menu .....	146
Key Assign Menu .....	147
Key Options Menu .....	148
OMNEO Offers Menu (KP-3016 Only) .....	150
Save Config Menu .....	150
Service Menu .....	151
 <b>UNICODE SUPPORT .....</b>	 <b>155</b>
AZedit and Unicode Support .....	155
 <b>POWER SUPPLY MOUNTING .....</b>	 <b>159</b>
Mounting the Power Supply to a Standard Rack .....	159
 <b>EKP-3016 .....</b>	 <b>161</b>
Introduction .....	161
Specifications .....	161
EKP-3016 Expansion Panel Reference View .....	162
Expansion Panel Cabling Reference .....	162
Mounting the Power Supply to the EKP-3016 .....	163

---

# List of Figures

---

FIGURE 1.	KP-3016/3016A Audio Flow Block Diagram .....	14
FIGURE 2.	KP-3016 Reference View .....	15
FIGURE 3.	KP-3016A Reference View .....	15
FIGURE 4.	KP-3016/3016A Installation .....	18
FIGURE 5.	Female Headset Connector Set Screw Access Hole .....	24
FIGURE 6.	Male Headset Connector Set Screw Access Hole .....	25
FIGURE 7.	KP-3016 Keypad .....	32
FIGURE 8.	KP-3016 AUX VOL. Knob and KP-3016A MENU Knob .....	35
FIGURE 9.	Key Function Position Explanation .....	36
FIGURE 10.	Talk/Listen Indicators .....	37
FIGURE 11.	Graphical Call Waiting Window .....	43
FIGURE 12.	Graphical Call Waiting Window Highlighted Call .....	44
FIGURE 13.	Keypanel Colors Window .....	49
FIGURE 14.	Color Grid .....	51
FIGURE 15.	Key Assignments Page .....	52
FIGURE 16.	Assignments Groups Page .....	53
FIGURE 17.	Miscellaneous Colors Page .....	55
FIGURE 18.	Flash Text Characteristics Window .....	60
FIGURE 19.	Show Icon Characteristic Window .....	62
FIGURE 20.	Tally (key) icon 512x64 pixel bitmap of key icons .....	64
FIGURE 21.	512 x128 pixel bitmap of panel icons .....	65
FIGURE 22.	Automatic Gain Control Example .....	87
FIGURE 23.	Mounting Bracket – Horizontal on a Crossbar .....	159
FIGURE 24.	Mounting Bracket – Vertical from a Crossbar .....	160
FIGURE 25.	EKP-3016 Expansion Panel Reference View - Front and Rear .....	162
FIGURE 26.	Expansion Panel Cabling .....	162





# *Introduction*

---

Part of the KP-Series keypanel family, the KP-3016 provides the same superior digital audio as the flagship KP-4016 model, by using OMNEO media networking technology (developed by RTS parent company Bosch and incorporating Dante high-quality audio over IP). The analog-only KP-3016A is also available. Both versions deliver top-notch sound quality, free of noise, delay, and other artifacts sometimes present in older technology.

---

## *Features*

- Wide viewing-angle color screen
- Ergonomic levers for talk/listen
- Full support for OMNEO - KP-3016 Only
- Support for 4-wire analog connection
- Expansion panel option available. (EXP-3016 only)
- Built-in speaker.
- Microphone input for dynamic or electret mics
- User-replaceable XLR headset connector – 4- or 5-pin available

## Specifications

### LCD Display

#### KP-3016/3016A:

Active Area .....	120.10mm (wide) x 18.77mm (high)
Dot Resolution.....	576 x 90 pixels
Color Resolution .....	16-bit (64K) RGB color
View Angle.....	80 degrees (typical; all directions)

### Power Supply:

Type:.....	External DC
AC Input:.....	100–240VAC 50/60Hz

### Inputs:

#### Matrix

Type .....	Balanced
Typical Input Level .....	+8dBu
Typical Input Impedance .....	>10k $\Omega$
Maximum Input Level.....	+20dBu
Supported Bandwidth.....	100Hz to 20kHz

### Panel Mic

Type .....	Electret
Typical Input Level .....	-42dBu
Typical Input Impedance .....	1.0k $\Omega$
Maximum Input Level.....	-25dBu

### Headset Mic - Electret

Typical Input Level .....	-42dBu
Typical Input Impedance .....	1.0k $\Omega$
Maximum Input Level.....	-25dBu

### Headset Mic - Dynamic

Typical Input Level .....	-50dBu
Typical Input Impedance .....	600 $\Omega$
Maximum Input Level.....	-25dBu

### Outputs:

#### Matrix

Type .....	Balanced
Typical Output Level.....	+8dBu
THD+N% .....	<0.20%
Typical Output Impedance .....	600 $\Omega$
Maximum Output Level .....	+20dBu
Frequency Response.....	100Hz to 20kHz

### Headset

Maximum Output Power .....	125mW for 32 $\Omega$ load
Earphone Impedance .....	16 $\Omega$ and above
THD+N%.....	<0.20%
Frequency Response .....	100Hz to 20kHz

### Speaker

SPL .....	84dBSPL for 1kHz sine wave @ 1 meter
-----------	--------------------------------------

### Digital (KP-3016 Only):

#### OMNEO Channels

Typical OMNEO Latency.....	1.0ms
Frequency Response .....	20Hz - 20kHz

### Environmental:

#### Dimensions

##### KP-3016

17.39" W (without rack ears) x 1.72" H x 3.88" D (441.82mm x 43.8mm x 98.5mm [111.11mm including volume knobs and lever keys])
--

##### KP-3016A

17.39" W (without rack ears) x 1.72" H x 3.88" D (441.82mm x 43.8mm x 98.5mm [111.11mm including volume knobs and lever keys])
--

### Weight

KP-3016.....	3.35 lb (1.52kg)
KP-3016A .....	3.35 lb (1.52kg)
Power Supply .....	0.53lb (0.24kg)
Power Supply Mounting Bracket .....	0.30lb (0.14kg)

### Temperature

Operating .....	0°C to 55°C (32°F to 131°F)
Storage .....	-20°C to 70°C (-4°F to 158°F)

***Power Consumption:***

***KP-3016***

Nominal..... 11 Watts  
 Maximum ..... 13 Watts  
 Maximum Volt Amp ..... 36 VA

***KP-3016A***

Nominal..... 8 Watts  
 Maximum ..... 10 Watts  
 Maximum Volt Amp ..... 36 VA

***Certification:***

***CE Compliance***

- EMC
- EN55022 Class A
- VCCI Class A
- ICES-003
- FCC Part 15 Subpart B Class A
- AS/NZS CISPR22 Class A
- Korean KN 22
- EN 55024
- Korean KN 61000-4
- BSMI Class B

***Safety***

- UL 60950-4
- EN60950-1
- CB Report
- PSE

KP-3016/3016A Block Diagram

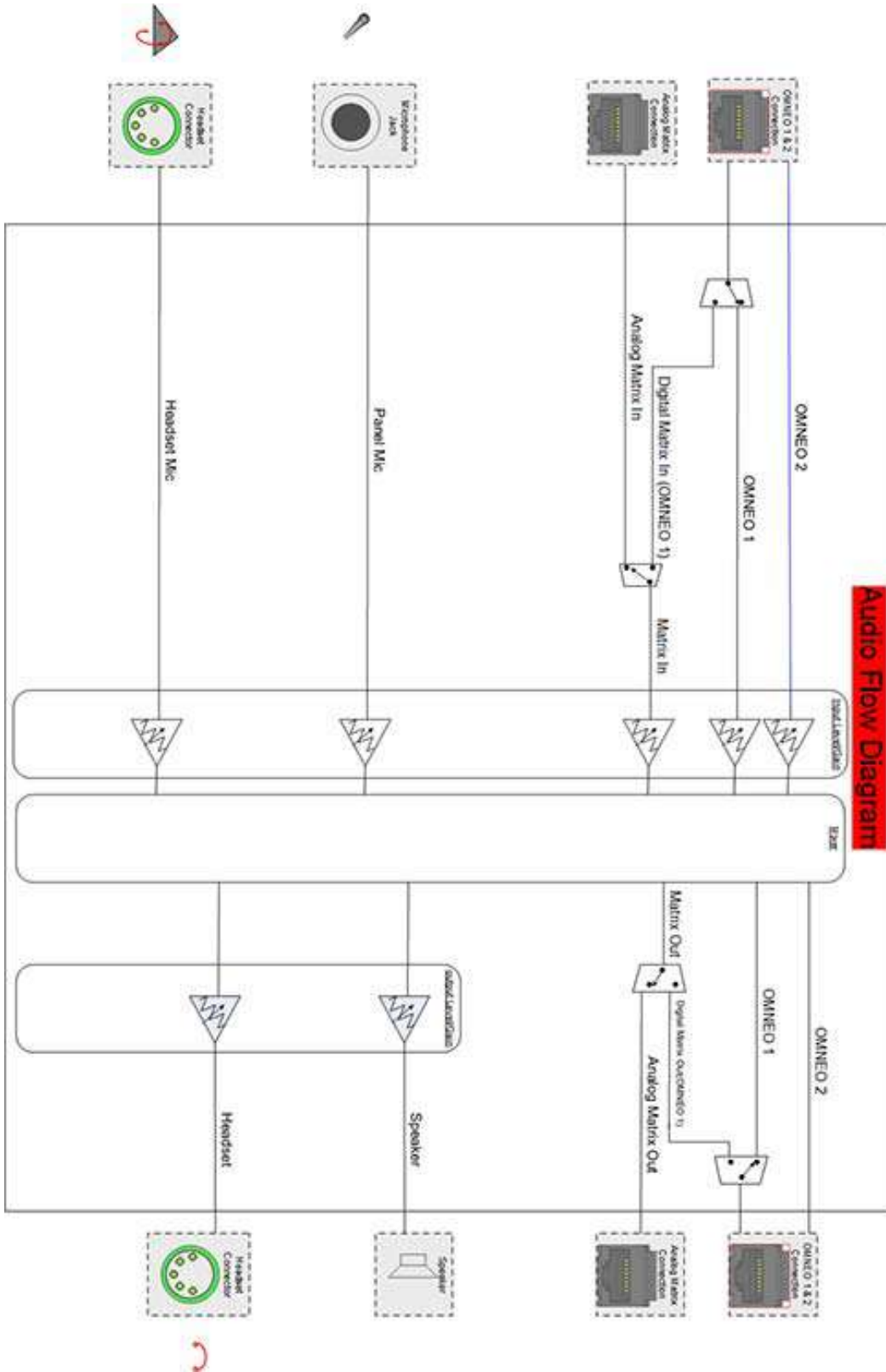

FIGURE 1. KP-3016/3016A Audio Flow Block Diagram

Reference View – KP-3016



FIGURE 2. KP-3016 Reference View

- |  |   |
|--|---|
| 1. Microphone Connector                  | 8. Speaker  |
| 2. Lever Keys                            | 9. Headset Connector  |
| 3. LCD Display                           | 10. POWER Connector   |
| 4. Keypanel Reset                        | 11. FRAME Connector   |
| 5. Keypad                                | 12. EXP Connector   |
| 6. AUX VOL. Encoder Knob/Menu Navigation | 13. OMNEO ETHERNET Connector (See “Ethernet Connector (KP-3016 ONLY)” on page 23) |
| 7. MAIN VOLUME Knob                      |   |



FIGURE 3. KP-3016A Reference View

- |  |                     |
|--|---------------------|
| 1. Microphone Connector                  | 10. POWER Connector |
| 2. Lever Keys                            | 11. FRAME Connector |
| 3. LCD Display                           | 12. EXP Connector   |
| 4. Keypanel Reset                        |                     |
| 5. Keypad                                |                     |
| 6. AUX VOL. Encoder Knob/Menu Navigation |                     |
| 7. MAIN VOLUME Knob                      |                     |
| 8. Speaker                               |                     |
| 9. Headset Connector                     |                     |

## Connector Pinouts

Power Supply: J1	
Pin	Assignment
Pin 1	24VDC
Pin 2	GND
Pin 3	Chassis GND

Matrix Connector: J8 <sup>a</sup>		
Pin	RJ-45	RJ-12
1	RS485 +	
2	RS485 -	RS485 -
3	FROM MATRIX +	FROM MATRIX +
4	TO MATRIX +	TO MATRIX +
5	TO MATRIX -	TO MATRIX -
6	FROM MATRIX -	FROM MATRIX -
7	RS485 +	RS485 +
8	RS485-	

a. Supports 568B and USOC wiring

EXP Connector: J9	
Pin	Assignment
1	
2	
3	
4	GND
5	GND
6	
7	RS485 +
8	RS485 -

ETHERNET: J11 (only for KP-3016, not KP-3016A)	
Pin	Assignment
1	Data 1 +
2	Data 1 -
3	Data 2 +
4	Data 3 +
5	Data 3 -
6	Data 2-
7	Data 4+
8	Data 4-

Panel Mic	
Pin	Assignment
Tip	PANEL_MIC_IN +
Ring	PANEL_MIC_IN -
Sleeve	CGND

Headset		
Pin	Assignment	
	4-Pin	5-Pin
1	HS_MIC_IN-	HS_MIC_IN-
2	HS_MIC_IN+	HS_MIC_IN+
3	HS_COMMON	HS_COMMON
4	HS_L_OUT	HS_L_OUT
5		HS_R_OUT

---

*Requirements*

The following keypanel firmware versions are needed for the specified KP-3016/3016A model:

- AZedit..... V5.2.0 or later*
- IPedit..... V3.2.0 or later*
- MCII-e..... V3.2.0 or later*
- AIO-16..... V1.6.0 or later*
- FWUT..... V3.3.0 or later (3016 Only)*
- DNS-SD..... V3.3.0 or later (3016 Only)*
- OMI..... V5.2.0 or later (3016 Only)*

## KP-3016/KP-3016A Installation

**IMPORTANT:** If you plan to use the Power Supply Mounting Bracket, we recommend you install the mounting bracket before cabling the keypanel. For information on different power supply mounting options, see “Power Supply Mounting” on page 159.

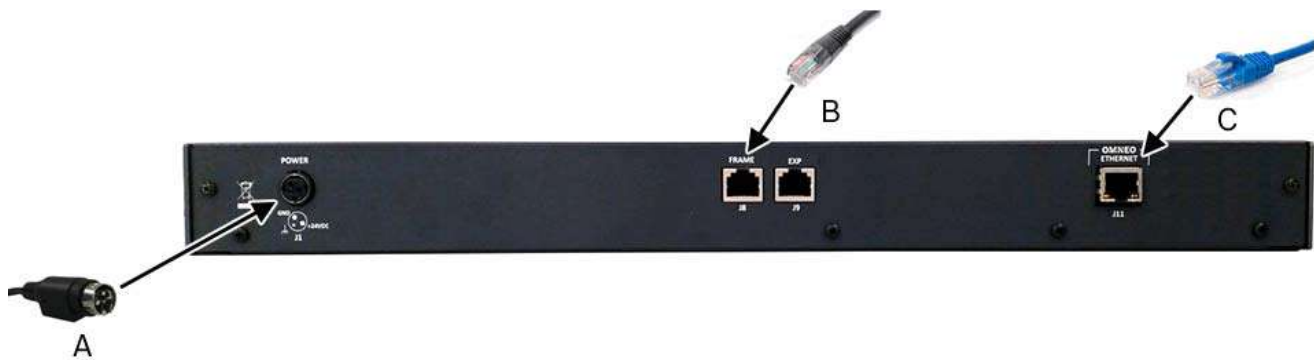

FIGURE 4. KP-3016/3016A Installation

**IMPORTANT:** When the OEI-2 power supply is used on a KP-3016/3016A keypanel, the following warning blinks to indicate the wrong power supply being used. The OEI-2 uses less voltage than the keypanel, therefore, when the power supply for the OEI-2 is used on a keypanel, degraded audio may be heard. No damage to the keypanel occurs.



To **install the KP-3016/3016A**, do the following:

1. On the rear panel of the KP-3016/3016A, plug the **24 VDC power connector (A)** of the power supply into the power connector on the back panel of the unit.
2. Connect an **RJ-12 or RJ-45 (568B or USOC) cable (B)** with RTS cabling to the J8 FRAME connector on the rear panel.  
OR  
Connect an **CAT-5e cable (C)** to the J11 ETHERNET connector on the rear panel (only available for the KP-3016)
3. Once the unit is cabled, plug the **power supply power cord** into the wall outlet or a power strip.



---

## Connecting the Keypanel

---

**IMPORTANT:** OMNEO is not available on the KP-3016A.

---

You can connect the OMI using AZedit and IPedit; however, only IPedit can be used to connect the keypanel.

### Configure the OMI using AZedit

To **connect the OMI to the KP-3016 using AZedit**, do the following:

1. From the Status menu in AZedit, select **I/O Cards**.  
*The I/O Card Status window appears showing a list of installed cards.*
2. Right-click the **OMI card** you want to connect to the keypanel.  
*A pop-up menu appears.*
3. From the pop-up menu, select **OMNEO Configuration**.  
*The OMNEO Configuration window appears.*
4. From the OMNEO card drop down menu, select the **slot number** where the OMI card is located in the frame.  
*The Device Name field auto-populates with the name of the device.*
5. From the Local Channel drop down menu, select the **channel** you want to use to communicate to your keypanel across the network.

**NOTE:** Channels not already configured to connect to another device appear with an asterisk (\*) next to them.

6. In the Partner Device Name field, enter the **name of keypanel** you want to use to communicate with. Or, select the **Browse icon** to select from a list of devices.  
OR  
In the Partner IP Address field, enter the **IP Address** of the device to which you want to connect. This field auto-populates when you select the Device Name.
7. From the Partner Device Type drop down menu, select the **type of device** to which the OMI card is connecting.
8. From the Partner Channel drop down menu, select **channel 1** on the device to which the OMI communicates.
9. Once you are completely finished, click **Apply**.  
*Apply sends the changes to the cards in the intercom, or Click Cancel to discard all the changes made.*

### Add the OMI to the Device Catalog in IPedit

To **add the keypanel to IPedit**, do the following:

1. Open **IPedit**.
2. From the Device menu, select **Add**.  
*The Add Devices Window appears, open to the Search tab.*
3. Select the **OMI card**.  
*The Add button becomes active.*
4. Click the **Add button**.  
*The OMI card appears in the device catalog in the left panel.*
5. Click the **Done button**.  
*The Add Devices window closes.*

### Configure the OMI using IPedit

To **configure the OMI using IPedit**, do the following:

Using the Device Configuration and Status Pane

1. In the Device Name field, enter a **device name** familiar to you, if desired.  
*Initially OMI cards are given a default name.*

---

**IMPORTANT:** If you change the device name, this causes the device to reboot. It is not necessary to change the device name. However, if you do change the name, it is best to do this early in the setup so you do not have to revisit other devices that connect to this device and update them later.

---

2. In the Description field, enter a **description for the OMI card**, if desired.

Using the Channel Configuration and Status Section:

3. In the Channel Description field, enter a **channel description**, if applicable.
4. From the Destination Type drop down menu, select **OKP**.
5. In the Destination Device Name field, enter the **name of the device** to which the channel will connect.  
OR  
Click the... button.  
*The Discovered Devices Window appears.*  
Expand the **tree** to view the available devices.  
From the expanded tree, select the **device** to which you want to connect.  
Click **OK**.
6. From the Destination Channel drop down menu, select the channel to which the OMI will connect.
7. Send the **changes** to the OMI.

### Add the KP-3016 to the Device Catalog in IPedit

To **add the keypanel to IPedit**, do the following:

1. Open **IPedit**.
2. From the Device menu, select **Add**.  
*The Add Devices Window appears, open to the Search tab.*
3. Select the **keypanel**.  
*The Add button becomes active.*
4. Click the **Add button**.  
*The keypanel appears in the device catalog in the left panel.*
5. Click the **Done button**.  
*The Add Devices window closes.*

### Configure the KP-3016 using IPedit

To **configure the keypanel using IPedit**, do the following:

Using the Device Configuration and Status Pane

1. In the Device Name field, enter a **device name** familiar to you, if desired.  
*Initially, keypanels are given a default name.*

---

**IMPORTANT:** If you change the device name, this causes the device to reboot. It is not necessary to change the device name. However, if you do change the name, it is best to do this early in the setup so you do not have to revisit other devices that connect to this device and update them later.

---

2. In the Description field, enter a **description for the keypanel**, if desired.

Using the Channel Configuration and Status Section:

3. In the Channel Description field, enter a **channel description**, if applicable.

4. From the Destination Type drop down menu, select **OMI**.
5. In the Destination Device Name field, enter the **name of the device** to which the channel will connect.  
OR  
Click the... button.  
*The Discovered Devices Window appears.*  
Expand the **tree** to view the available devices.  
From the expanded tree, select the **device** to which you want to connect this keypanel.  
Click **OK**.
6. From the Destination Channel drop down menu, select the channel to which this keypanel will connect.
7. Send the **changes** to the keypanel.

### Connecting the KP-3016 through the OMNEO Offers Menu

---

**IMPORTANT:** If you used IPedit to set up the keypanel connection, this step not needed, because you have already done this in the software.

---

If you used AZedit to set up the keypanel connection, the keypanel needs to be set up to talk with the OMI card in the frame. To do this, a connection needs to be established using the OMNEO Offers menu on the keypanel. For more information, see “Menu System, OMNEO Offers (Only available for KP-3016)” on page 120.

To **configure a connection offer**, do the following:

1. Starting at the OMNEO Offers|Keypanel menu, select **OKP**.
2. Press the **SEL button**.  
*A list of available OMNEO offers appears.*
3. Using the AUX/MENU shaft encoder, select the **OMNEO offer** you want to use.  
*An arrow appears next to the device.*
4. Press the **CLR button** to exit menu mode.

---

### Power Up

At power-up, if the keypanel is connected to the matrix, the alphanumeric display shows dashes in the light blue color key



. After several seconds, the intercom key assignments are shown with the appropriate color keys and alphas.

**NOTE:** If the keypanel cannot establish communications with the intercom system, all keys continue to show asterisks

(\*\*\*\*) and the *Disconnected from Matrix* icon



appears in the panel display. If the keypanel is configured for OMNEO, this icon also displays the OMNEO device name. Check the keypanel to matrix cable connection if this occurs. If the keypanel loses communications with the intercom, the panel display shows the

Disconnected from Matrix icon and displays the



after approximately 30 seconds.

## Address Setting

### General Information

In ADAM intercoms using AIO-8 cards or AIO-16 cards with SCSI breakouts, and in ADAM-CS and Zeus/Zeus II intercoms, the intercom ports share data connections in groups of eight (8). Each keypanel is uniquely identified on the data port by its address. The method of determining the proper address varies for each intercom system. Use the method for your intercom system, as described on the following pages.

**TABLE 1.** KP-3016/3016A Addressing

Manually Addressed	Automatically Addressed
<p>You must manually address<sup>a</sup> the keypanel when using the following:</p> <ul style="list-style-type: none"> <li>• AIO-8 on ADAM</li> <li>• AIO-16 SCSI on ADAM</li> <li>• ADAM CS</li> <li>• Zeus I</li> <li>• Zeus II</li> </ul>	<p>The keypanel address is automatically detected when using the following:</p> <ul style="list-style-type: none"> <li>• AIO-16 MDR on ADAM and ADAM-M</li> <li>• Cronus</li> <li>• Zeus III and Zeus III LE/LE+</li> <li>• RVON Products - RVON-8, RVON-2, RVON-C, and RVON-16</li> </ul> <p><b>NOTE:</b> Keypanels using RVON-I/O may need to be individually addressed. See the RVON-I/O user manual for further instruction.</p>

a. To manually address the KP-3016/3016A, see “Service Menu, Set Address” on page 133.

To see specific addressing information for:

- ADAM with AIO-8 cards, see the ADAM technical manual (P/N F01U216986).
- ADAM CS, see the ADAM CS technical manual (P/N 93307517000).
- ADAM and ADAM-M with AIO-16 cards, see the AIO-16 user manual (P/N F01U193267).
- Cronus, see Cronus user manual (P/N F01U118890).
- Zeus III, see the Zeus III user manual (P/N F01U193289).
- Zeus III LE/LE+, see the Zeus III LE/LE+ user manual (P/N F01U193290).

**NOTE:** If you are connecting to an ADAM or ADAM-M frame with AIO-16 cards using MDR connectors or a Cronus frame, you do not need to set the address. If the AIO-16 is using SCSI breakouts, you must set the address.

## Connections

### Frame Connector

Use the Frame connector to connect to an intercom port of the intercom system. For the frame connector location, see Figure 3 on page 15. The intercom port you connect to should agree with the address you set previously.

### Ethernet Connector (KP-3016 ONLY)

Use the Ethernet connector to connect the keypanel to a network system. Each RJ-45 Ethernet connector has two (2) LEDs:

**Left LED.** The left LED is yellow and indicates a network link is established. It flashes on/off whenever there is network activity.

**Right LED.** The right LED is bi-color (orange and green) and indicates the speed of the connection by the color that is displayed.

- A green LED indicates the port is operating at 1000Mbps (1 Gbps).
- An orange LED indicates the port is operating at 100Mbps.
- No LED color indicates the port is operating at 10Mbps. This is not suitable for OMNEO networking.

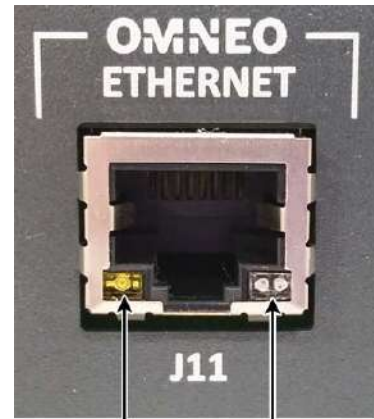

**Left LED (yellow)**      **Right LED (bi-color orange/green)**

### Panel Microphone Connector

A panel microphone may be connected to the front of the unit. The connector accepts MCP5, MCP6, or MCP90 series panel microphones. Insert the microphone and rotate the entire microphone body clockwise several turns to lock it in place.

## Headset Connector

A stereo headset may be connected to the front of the unit for use along with or in place of the front panel speaker and a separate microphone. Headphones may be connected for use with a separate microphone.

### *Female Headset Connector*

For a female headset connector, the set screw access hole is located on the bottom-right side of the unit.

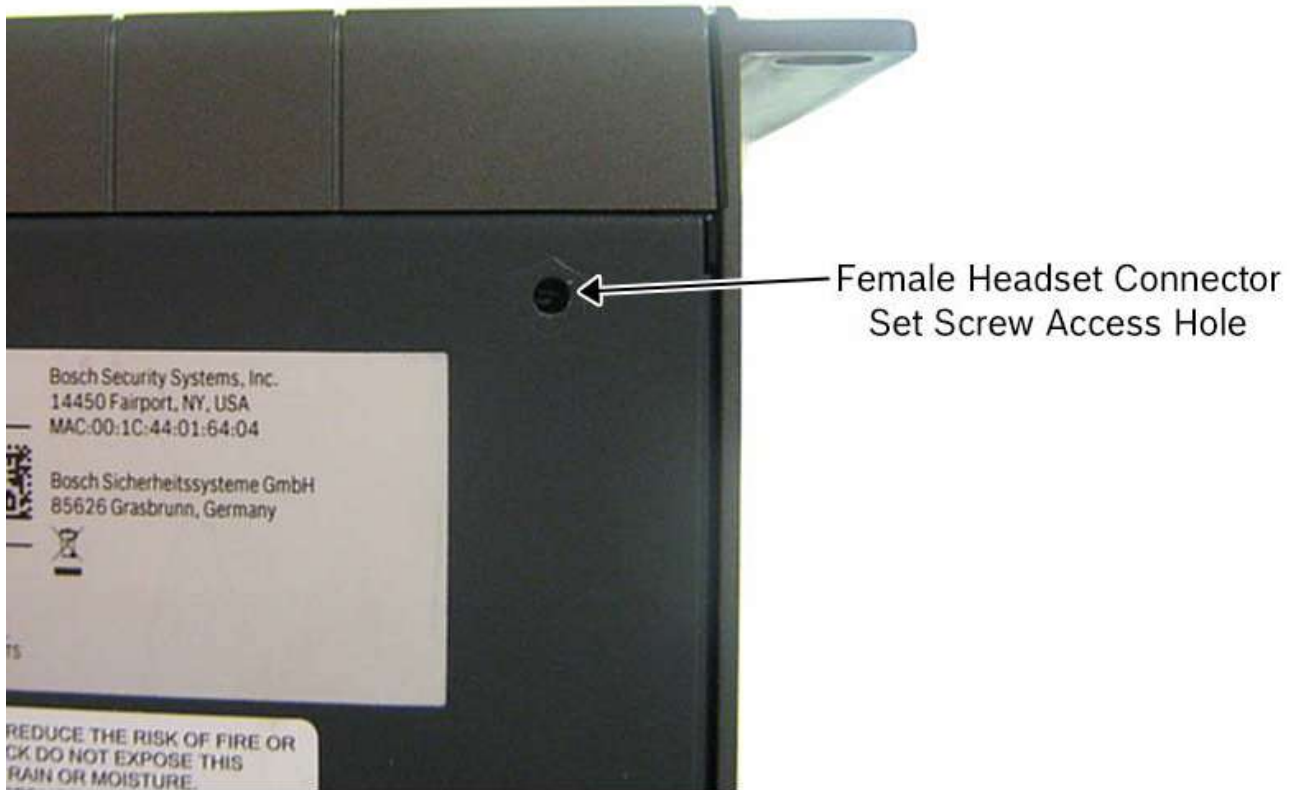

Bottom Panel View – KP-3016/3016A

**FIGURE 5.** Female Headset Connector Set Screw Access Hole

*Male Headset Connector*

For a male headset connector, the set screw access hole is located on the right-side of the unit.

---

**IMPORTANT:** The right-side rack ear must be removed to expose the set screw access hole.

---



**FIGURE 6.** Male Headset Connector Set Screw Access Hole

### *Changing the Headset Connector*

The headset connector can be switched between a 4-pin XLR and 5-pin XLR (also compatible with 6-pin) connector.

To **replace the front panel headset connector**, do the following:

1. Using a flat-blade screwdriver with 2.4 mm wide (3/32 in.) tip, turn the **set screw counterclockwise** to loosen the connector from the unit.



2. Once the connector is loose, tip the **unit** and gently shake the **connector loose**.
3. Carefully pull the **headset cables** free from the chassis.



**NOTE:** If the cable assembly becomes caught, shift the cable up and down to clear the cable from the unit.



4. Cut the **shrink-tubing** from around the cables. Pay attention not to cut through the cables.



5. Disconnect **both cables** by pulling the cable-to-cable connectors apart.

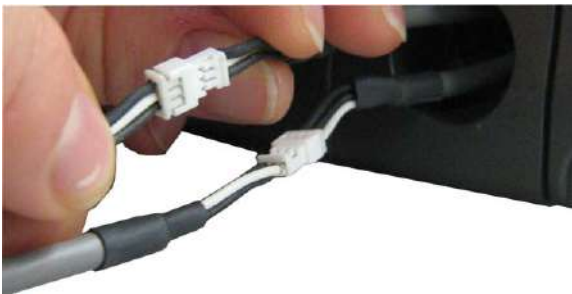

6. Using the replacement headset connector, thread the **cables** through the supplied shrink-tubing.

---

**IMPORTANT:** You must thread the shrink tubing on the long cable on the replacement connector and the long cable protruding from the keypanel headset connector opening.

---



7. Connect the **cable-to-cable connectors**.

**NOTE:** Take care to reconnect the proper gender connectors when reassembling the headset cable.

- Position both pieces of **shrink-tubing** so any portion of the cable without an outer insulation layer is covered.



- Using a heat gun, apply **even heat over the length and diameter of the tubing** (minimum temperature 100°C).

---

**IMPORTANT:** Since uncontrolled heat can cause uneven shrinkage, physical damage, and insulation failure, the use of open flame is not recommended. Avoid overheating the heat shrink-tubing because it can become brittle and/or charred.

---

- Gently push the **headset connector cable** back into the unit.
- Align the **rib on the headset connector with the notch in the connector opening** and press the connector completely in.
- While holding the connector in place, turn the **set screw clockwise** to tighten the connector in position.















---

*Intercom Keys and Displays***Color Display Descriptions for Intercom Keys**

The KP-3016/KP3016A display uses key colors to distinguish the type of key assignment programmed on each key. Use Table 2, to help you determine the available key assignment colors.

You can customize these colors to your preference by using the “Keypanel Color Window” on page 49.

**TABLE 2.** Default Key Colors

Default Color		Description
	Amber	Waiting for Footswitch
	Bright Green	Listen Indicator, Local Matrix
	Brown	IFB Special List
	Teal	Point-to-Point
	Dark Yellow	ISO
	Light Blue	Unassigned, Test Mode (with Talk and Listen Indicators)
	Pale Yellow	Special Functions
	Magenta	Relay
	Pink	Party Line
	Red	Remote Matrix
	Salmon	IFB, Talk Indicator
	Pale Green	Special List
	Periwinkle	UPL Resource

## Display Icons

**Display Icons** are used to indicate the accessories and features enabled, disabled, active, and inactive. Use Table 3 for a complete description of each icon seen on the KP-3016/3016A.

**TABLE 3.** Display Icon Descriptions



















Icon	Icon Name	Description
	Matrix Connected	The keypanel is connected to the Matrix. This icon briefly displays at connection.
	Disconnected From Matrix	There is no connection between the Matrix and the keypanel. This icon is displayed as long as there is no Matrix data connection.  <b>NOTE:</b> When the keypanel is disconnected, it displays its Device Name (for OMNEO) or IP Address (for RVON) device connections.
	Firmware Download	Firmware is being downloaded to the keypanel. A progress bar at the bottom displays: chunk progress overall progress chunk/overall progress  <b>NOTE:</b> For more information, see “Download Firmware to the KP-3016/3016A From AZedit” on page 67.
	Headphones	The headphones are enabled. This indicates the headset microphone is not enabled.
	Headset	The headset is enabled. To enable the headset, see “Audio Options Menu, Headset Speaker” on page 98.
	Headset Mute	The headphone is muted. If the headset mic is muted, MIC MUTE is shown instead of HDST MUTE
	Microphone	The microphone is enabled.
	Microphone Mute	The microphone is muted. To mute the microphone, see “Audio Options Menu, Mic Mute” on page 102. To mute the headset mic, see “Audio Options Menu, Headset Mic” on page 97
	Speaker	The speaker is enabled. To enable the speaker, see “Audio Options Menu, Speaker” on page 104.
	Speaker Mute	The speaker is muted.
	Snoop Tally Active	Snoop Tally is Active on the keypanel. You must have the Hot Mic enabled to use snoop tallies. To enable snoop tallies, see “Service Menu, Snoop Tally” on page 134.
	Hot Mic	The hot mic is active. To activate Hot Mic, see “Audio Options Menu, Matrix Out” on page 101.
	Tone 1kHz Enabled	Tone 1kHz is enabled on the keypanel. To enable tone 1kHz, see “Audio Options Menu, Tone Gen” on page 104.

TABLE 3. Display Icon Descriptions

Icon	Icon Name	Description
	Tone 500Hz Enabled	Tone 500Hz is enabled on the keypad. To enable tone 500Hz, see “Audio Options Menu, Tone Gen” on page 104.
	Main Volume Bar	The main volume bar is used to control the volume for the keypad inputs and outputs, including all speaker and headset outputs, and matrix inputs.
	Key Volume Bar	The key volume bar is used to control the listen gain on a per key level. The listen gain range is +6dB to -80db, or Mute.  <b>NOTE:</b> Listen must be assigned on the key assignment for this function to operate.
	OMNEO Enabled	**This is only applicable for the KP-3016 keypad.**  The OMNEO matrix interface is enabled on the panel. For more information on OMNEO Offers, see “Menu System, OMNEO Offers (Only available for KP-3016)” on page 120.
	OMNEO Disabled	**This is only applicable for the KP-3016 keypad.**  The OMNEO matrix interface is disabled on the panel. For more information on OMNEO Offers, see “Menu System, OMNEO Offers (Only available for KP-3016)” on page 120.
	Matrix Input Mute	The Matrix Input volume is muted. When the Matrix Input volume is adjusted down to Mute, the panel displays this flashing icon as a warning that there is no audio from the Matrix.

## Keypad Reference View

With both the KP-3016/3016A there are two (2) tiers to each keypad's keypad: Primary Mode and SHIFT Mode.

### Primary Mode

**Primary Mode** is used for the most common keypad functions, such as CLR, SEL, and accessing the Main menu. There are no special keypad sequences to use these functions.

### Shift Mode

**SHIFT Mode** contains secondary functions used to access more functionality. The SHIFT mode functions are located above the primary keypad key. The shift functions available; *INFO*, *LEFT/RIGHT*, *COPY*, *PAGE*, and *TYPE*.

**NOTE:** By default, the keypad backlight changes to *white* when the keypad is in SHIFT mode. For more information, see "Service Menu, Keypad" on page 125.

To **access Shift Mode**, do the following:

1. On the keypad, press the **SHIFT** button.
2. On the keypad, press the **key whose SHIFT function** you want to access.

**NOTE:** Once you enter SHIFT mode, you can exit the mode by pressing the SHIFT key again, without pressing any other keys.



FIGURE 7. KP-3016 Keypad

Keypad Button	Shift Function	Description
LOC	TYPE	The LOC/TYPE button displays the list of available intercoms (LOCations) available to scroll from. Select an intercom name to access the scroll lists for that intercom. The TYPE button displays the keypad assignment types available for scrolling.
←	←←	The ←/←← button moves you backwards through the menu options or available key assignments one at a time or by the page.

Keypad Button	Shift Function	Description
MENU	INFO	<p>The MENU/INFO button is used to access the top level menu structure or access a secondary menu of commonly used features (see, “INFO button” on page 34).</p> <p>The MENU button is used to access the top-level menu structure.</p> <ul style="list-style-type: none"> <li>&gt; Press the <b>Menu button</b> once. <i>The top-level menu appears in the panel display.</i></li> </ul> <p><b>NOTE:</b> If the keypad backlight is set to On Keypress (Service Keypad Backlight Activation), you must press the Menu button twice to access the top-level menu. Using the ← and → buttons you can scroll through the list of options available. When a selection is highlighted, Press the SEL button to navigate down one (1) level in the menu structure.</p> <p>To <b>access the INFO menu</b>, do the following</p> <ol style="list-style-type: none"> <li>1. Press the <b>SHIFT button</b>.</li> <li>2. Press the <b>MENU/INFO button</b>. <i>The INFO menu appears in the panel display.</i></li> </ol> <p>For more details about the INFO button, see “INFO button” on page 34.</p>
→	→→	<p>The →/→→ button moves you forward through the menu options or available key assignments one at a time or by the page.</p>
COPY	COPY	<p>The COPY button is used to copy an incoming call key assignment from the CWW to a specific keypad key.</p> <p>For example, if caller THREE calls the keypad, and there is no keypad key assigned, THREE appears in the CWW window in the keypad display. If the keypad operator wants to assign the caller (THREE) a key, use the COPY key on the keypad, and then tap the keypad key where THREE is to be assigned.</p> <p>You can also copy from key to key by pressing the COPY+SEL or SHIFT+COPY buttons, and then tapping the source key and target key.</p>
PAGE	PAGE	<p>The PAGE button is used to access a different setup page. You can configure up to 15 pages in the intercom system. The default number of pages is <i>four (4)</i>. To configure the number of pages available use the Intercom Configuration window, on the Options Page in AZedit.</p> <p>To <b>enter the graphical page change mode</b>, do the following:</p> <ul style="list-style-type: none"> <li>&gt; Press the <b>PAGE+ SEL buttons</b>.</li> <li>OR</li> <li>Press the <b>SHIFT+PAGE buttons</b>.</li> </ul>
CLR		<p>The CLR button also functions as a back button or a full menu exit. The CLR button is also used to hide the CWW window.</p> <p>To <b>clear a menu</b>, do the following:</p> <ul style="list-style-type: none"> <li>&gt; Press and hold the <b>CLR button</b> for half a second.</li> </ul> <p>To <b>clear the CWW</b>, do the following:</p> <ul style="list-style-type: none"> <li>&gt; Press the <b>CWW key up</b> to pop entries out of it.</li> </ul>
SHIFT		<p>The SHIFT button accesses the secondary keypad actions such as INFO, TYPE, etc.</p>
SEL		<p>The SEL button is used to select options highlighted in the menu structure.</p>

## INFO button

The **INFO** button is used to access commonly used features and configuration options for the keypanels. These include the following:



Feature	Description
Panel ID	Displays the port number and alpha of the keypanel.
Level 2	Displays the Talk Level 2 key assignments on the keypanel.
Listen	Displays the listen key assignments on the keypanel.
Callers	Displays a list of current callers to the keypanel.
Assign Types	Displays the assignment types of all the configured keypanel keys.
Matrices	Displays the Matrix for each key assignment.
Tone	Opens the Tone Generator menu. For more information, see “Audio Options Menu, Tone Gen” on page 104.
Setup Pages	Displays the setup pages assigned to each row of keys. You cannot change setup pages from this menu.
Reset Vols	Opens the Key Volumes Reset menu. For more information, see “Audio Options Menu, Key Volumes” on page 100.
Hidden Asgns	Displays key assignments assigned to virtual keys (ie, assignments not currently visible).
Test Panels	Enables the Test Panel feature. For more information, see “Service Menu, Test Panel” on page 135.
Version	Displays the firmware version of the KP-3016/3016A. For more information, see “Display Menu, Version” on page 108.

To **access the Info Menu**, do the following:

1. On the keypad, press the **SHIFT** button.
2. On the keypad, press the **INFO MENU** button.  
*The INFO menu appears in the panel display.*

**NOTE:** To exit the INFO menu mode, press the **CLR** button.



---

## Menu Navigation and Shaft Encoder Knobs

While the keypanel is in menu mode, the **Aux Volume** shaft encoder (labeled MENU on the KP-3016A keypanel) is used to move the selection left and right. Or, in the case of a single menu item with up and down control, the shaft encoder is rotated to scroll through the available selections. This is particularly convenient when setting the keypanel brightness or gain. Also, pressing the Aux Volume shaft encoder while in menu mode is the equivalent to SEL key operation. Conversely, pressing the **MAIN Volume** shaft encoder in menu mode is the equivalent to the CLR key operation.



**FIGURE 8.** KP-3016 AUX VOL. Knob and KP-3016A MENU Knob

Other navigation options:

- Press and hold the AUX/MENU shaft encoder to exit the menu.
- Double-tap the AUX/MENU shaft encoder to go backwards in the menu.

---

## CLR Button

The **CLR** button is used either as the BACK function while in MENU mode or to exit MENU mode completely.

To **go back one menu level**, do the following:

- > Press the **CLR button once**.

To **exit the menu**, do the following:

- > Press and hold the **CLR button for half a second**  
OR  
Press the **CWW key up**.

---

## Basic Intercom Key Operation

---

**IMPORTANT:** The KP-3016/3016A series keypanels, as well as the EKP-3016, do not have side to side movement on the lever keys. You are only able to press up or down. Left and right motions are not available.

---

To **talk on the KP-3016/3016A**, do the following:

- > Press **down** on the keypanel key you want to use.

To **listen on the KP-3016/3016A**, do the following:

- > Press **up** on the keypanel key you want to use.



**FIGURE 9.** Key Function Position Explanation

## Talk/Listen Indicator

The **Talk/Listen Indicator**, shown in Figure 10, displays a visual indicator when the talk and/or listen key is active. The talk and listen states of each key are represented by an LED-like horizontal bar at the bottom (talk) and top (listen) of each key.

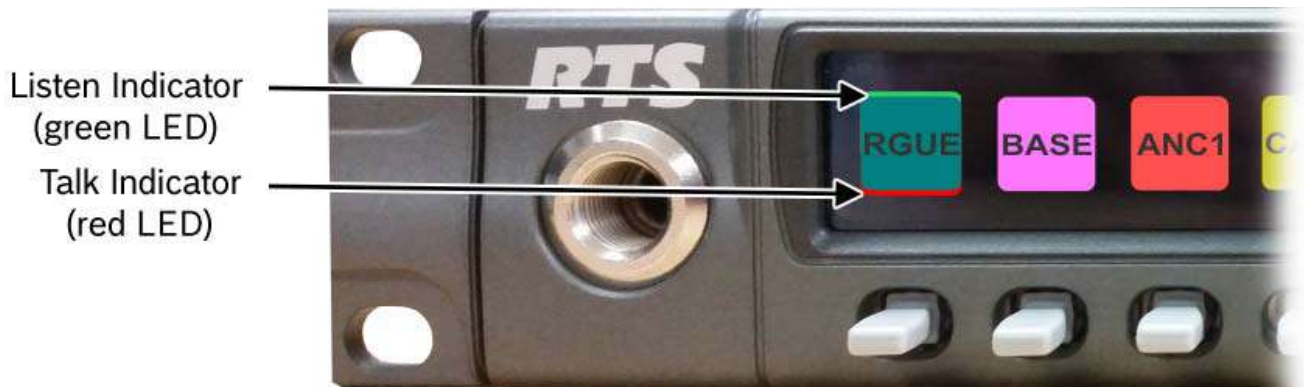

**FIGURE 10.** Talk/Listen Indicators

By default, the listen indicator is *green* and the talk indicator is *red*. You can change the colors of the indicator by using the Key Color Window in AZedit. For more information, see “Keypanel Color Window” on page 49.

---

## Crosspoint Gain Adjustment

**Crosspoint Gain Adjustment** gives you the ability to adjust an individual crosspoint gain associated with different assignments. For example, you can decrease the gain (audio strength) of key assignment assigned to a person with a strong (loud) voice.

To **adjust the crosspoint gain**, do the following:

1. Lift and hold the **listen key** for which you want to adjust the crosspoint gain.
2. Turn the **AUX Vol. (MENU) encoder knob to the right** to increase the gain.  
OR  
Turn the **AUX Vol. (MENU) encoder knob to the left** to decrease the gain.  
*The gain is shown on the key.*

## Keypanel Volume Adjustments

By default, the main volume control adjusts the Output Volume for the speaker or headset, whichever is currently active.

Output volume ranges from +10dB to -48dB and Mute.

To **adjust output volume level**, do the following:

- > On the KP-3016/3016A, turn the **MAIN VOLUME encoder** to the right to increase the volume for the selected output.  
OR  
Turn the **MAIN VOLUME encoder** to the left to decrease the volume for the selected output.

**NOTE:** When the MAIN VOLUME encoder is turned, the volume level bar appears in the panel display.



**NOTE:** You can save the volume adjustments to be power-up defaults using “Menu System, Save Config” on page 121.

To **select a different output volume control**, do the following:

- > On the KP-3016/3016A, push the **MAIN VOLUME encoder** once.  
*The main volume focus switches to the next available output.*



### Aux Volume Adjustments (KP-3016 Only)

The **Aux Volume** control knob adjusts the Matrix Input and OMNEO input volumes.

**IMPORTANT:** If you adjust the Matrix Input volume down to Mute, then the panel displays a flashing Mtx Mute icon as a warning there is no audio from the Matrix.



Input volume ranges from +10dB to -48dB and Mute.

To **adjust input volume level**, do the following:

- > On the KP-3016/3016A, turn the **AUX VOLUME encoder** to the right to increase the volume for the selected input.  
OR  
Turn the **AUX VOLUME encoder** to the left to decrease the volume for the selected input.

**NOTE:** When the AUX VOLUME encoder is turned, the volume level bar appears in the panel display.



**NOTE:**

- You can save the volume adjustments to be power-up defaults using “Menu System, Save Config” on page 121.
- The inputs appear in the Aux Volume menu if they are enabled and mixed to an output.

**IMPORTANT:** When OMNEO is present and the keypanel is configured with an AIO connection to the Matrix, OMNEO 1 can be used as an AUX input. To adjust OMNEO 1 volume, the OMNEO 1 input must be mixed to an output (any output).

To **change the focus of the volume control**, do the following:

- > On the KP-3016, push the **AUX VOLUME encoder** once.  
*The aux volume focus switches to the next available input.*



### *Operation of Intercom Keys with Auto Functions*

**NOTE:** Assignment of keys with auto functions is described in the programming section that follows.

Operation of keys with auto functions, is as follows:

<i>Talk+auto follow</i>	Talk and listen can be activated separately. The listen assignment listens to whatever is assigned to the talk key.
<i>Talk+auto listen</i>	Both talk and listen activates when talk is activated.
<i>Talk+auto mute</i>	Listen turns off when talk is activated.
<i>Talk+auto reciprocal</i>	Listen is always on and talk may be turned on or off.
<i>Talk+auto table</i>	If an IFB talk key has an auto table listen assignment, talk and listen is independently activated. The listen key listens to whatever is defined as the IFB Listen Source for the IFB assigned to the talk key.
<i>All Call</i>	Activating this key activates all keys to the left of it, up to, but not including another all call key.
<i>Talk+DIM</i>	If a point-to-point key has the DIM function as a level 2 talk assignment, activating the key causes the crosspoint levels to diminish for any other intercom ports currently listening to the same destination and are in the same DIM tables.

---

## *Operation of Intercom Keys with Options*

### **Group Option Keys**

Activating the master key in a key group activates all keys in the group according to each key's individual key assignment. Activating a slave key does not affect any other keys in the group. For more information, see "Key Options Menu, Key Groups" on page 117.

### **Solo Key**

Activating a key with the solo option causes all other keys to turn off until the solo key is turned off. For more information, see "Key Options Menu, Solo" on page 118.

### **Exclusive Key**

Activating a key with the exclusive options causes all other Exclusive keys to turn off when activated. Unlike the solo option, when exclusive is deactivated, the keys turn off and stay off. For more information, see "Key Options Menu, Exclusive" on page 115.

### **Lock Key**

A key with the lock option on it is locked in the on or off position and cannot be changed until the lock is removed. For more information, see "Key Options Menu, Lock (Button Lock)" on page 118.

### **Chime Key**

When a chime is configured on a key and a call is received, the chime is activated. You can configure length and type of chime for the key, as well. For more information, see "Key Options Menu, Chime" on page 114.

### **Clear Keys**

Clearing keys is used to remove any key options assigned to a specific key. For more information, see "Key Options Menu, Clear" on page 115.

### **Latching Keys**

Latching keys on a keypanel gives the user hands-free operation where keys stay active after quickly tapping the key. For more information, see "Key Options Menu, Latching" on page 117.

---

## *Operation of Intercom Talk Keys with the Speaker DIM Setting*

Activating any talk key causes the speaker or headphone volume at the keypanel to diminish by the amount specified in the DIM menu item on the Service menu. For more information, see "Audio Options Menu, Dim" on page 96.

**NOTE:** Do not confuse this with the Talk+DIM auto function previously described. Talk+DIM affects the speaker or headphones on other keypanels when a particular talk key is activated on the keypanel. Speaker DIM affects the speaker or headphone level on the keypanel when any talk key on the keypanel is activated.

---

## *Call Waiting Operation*

Occasionally, a keypanel may call and there is not a key assigned to talk back to the caller. In this case, the caller's name appears in the **CWW** (Call Waiting Window).

**NOTE:** The KP-3016/3016A keypanels support a graphical call waiting window. For more information, see "Graphical Call Waiting Window Operation" on page 44.

To **answer a CWW call**, do the following:

- > Press down and hold the **CWW key** to talk back.

To **clear a name from the CWW window**, do the following:

- > When the CWW window is populated, tap up on the **CWW key**.

**NOTE:** If a second call is received in the CWW while a caller name is already displayed, the Call Waiting window flashes.

To **answer a second call**, do the following:

- > Tap the **CWW key** up to clear the first name, and then hold the **CWW key** down to talk to the second caller.

**NOTE:** By default, only the names of callers who are not currently assigned to intercom keys appear in the call waiting window. Alternately, you can force all caller names to display in the call waiting window. This is controlled by DIP Switch 2 on the ADAM Master Controller card or the *Always stack callers in the call waiting window* option found in AZedit (*Options/Intercom Configuration/Options*). Setting this option in AZedit overrides the DIP Switch 2 setting on the Master Controller.



### Graphical Call Waiting Window

Traditionally, incoming calls have been displayed on key 16 on the keypanel, flashing to indicate an incoming call. The KP-3016/3016A Series keypanel can keep a history of the last nine (9) callers and display them in a scrollable, graphical window above keys 15 and 16. The CWW displays three (3) calls at a time (only two in Unicode) with a scroll arrow appearing if there are more than three (3) calls in the list.



FIGURE 11. Graphical Call Waiting Window

TABLE 4. Graphical CWW Call Description

Item	Description
New Call	White background
Selected Call / Not Talking	Cyan background
Selected Call / Talking	Green background
Old Call	Gray background

## Graphical Call Waiting Window Operation

Use Table 4 on page 43 and Figure 11 on page 43 to understand the different states of the CWW.

### *Display or Hide the CWW*

To **display the CWW**, do the following:

- > On the KP-3016/3016A panel, lift up on the **CWW key**.  
*The graphical call waiting window appears.*

To **hide the CWW**, do the following:

- > Press the **CLR button**.  
*The CWW closes.*

**NOTE:** If the CWW list is visible and not empty, it remains visible until hidden. If the CWW list is visible, but empty, it auto-hides after a five-second timeout.

### *Incoming Calls*

When a call is received at the KP-3016/3016A panel, the graphical CWW list appears on the keypad display. Unlike the keypad tally indicators in previous keypad versions:

- the graphical CWW list appears on the keypad display.
- the graphical CWW and the call flashes (tallies), rather than the CWW button.

Up to nine (9) calls can be stored in the CWW history scroll list. The most recent call is inserted at the top of the graphical CWW list (position 1) with a white background (See Figure 11 on page 43). Other items in the CWW list are shifted down, as necessary. The ninth call in the list is dropped when a new call is received.



**FIGURE 12.** Graphical Call Waiting Window Highlighted Call

**NOTE:** A highlighted item in the graphical CWW cannot be shifted off the CWW list.

To **scroll the CWW list**, do the following:

- > When the CWW list is visible, use the arrow buttons to scroll through the list.  
*The highlight moves through the scroll list.*

To **answer a call on the graphical CWW**, do the following:

1. Scroll the **CWW** to highlight the call you want to answer.  
*The highlighted call is shown with a cyan background.*
2. Press down and hold the **CWW key** to talk to the caller.  
*The highlight in the CWW list turns green and moves to the top of the list when talking with the caller.*
3. Release the **CWW key** to stop talking.  
*The call is ended. The background of the caller in the CWW list turns a light gray (if not highlighted).*

### ***Clearing the CWW List***

To **clear the CWW list**, do the following:

1. If the CWW is not visible, press the **CWW key** to make it visible and the call selected.
2. Use the button keys to scroll to the **call** you want to remove.
3. Press the **CWW key up**, to clear the selected entry.
4. Repeat **steps 2 & 3**, as necessary.





### Mic Select

The mic (input) or speaker/headset (output) can be configured as Always On or Enabled, or Disabled.

For more information, see:

- “Audio Options Menu, Headset Speaker” on page 99.
- “Audio Options Menu, Panel Mic” on page 105.
- “Audio Options Menu, Headset Mic” on page 98.

**TABLE 5.** Source Configuration Matrix and Display icons

	ALWAYS ON/ENABLED	SWITCHED	DISABLED	ICON DISPLAYED
<b>Panel Mic</b>				
	X	X		
			X	No icons display on the keypanel.
<b>Headset Mic</b>				
	X	X		
			X	No icons display on the keypanel.
<b>Speaker</b>				
	X	X		
			X	No icons display on the keypanel.
<b>Headset</b>				
	X	X		
			X	No icons display on the keypanel.

---

## Setup Pages

**Setup Pages** are used to provide access to more key assignments than a panel has keys, enabling the user to quick switch one set of assignments for another.

You can have *up to 15 Setup Pages per keypanel port*.

By default, four (4) Pages are configured.

**NOTE:** To change the number of Pages available for ports, in AZedit go to Options|Intercom Configuration|Options tab in AZedit. Change the Setup pages per port field to the number of pages needed. This causes the intercom to resize (first birthday), meaning the intercom configurations are erased.

To **open Setup Pages**, do the following:

- > On the keypanel keypad, press the **PAGE key**.
  - OR
  - On the keypanel keypad, press the **SHIFT +PAGE keys**.
- The graphical page mode appears in the keypanel display screen. The page tab displays turquoise.*

---

**IMPORTANT:** To add key assignments to the setup pages, see “Menu System, Key Assign Menu” on page 109.

---

To **toggle between the Setup pages**, do the following:

1. Use the **left and right arrow keys to change the page**.  
*When changing the page, the Page tab appears yellow, until selected.*
2. Press the **SEL key** to select the page.  
*The Page tab returns to the turquoise color. After two (2) seconds with no SEL button selection, the page is automatically selected.*

**NOTE:** Use SHIFT+Left/Right to switch between the Main and EKP page, when an EKP is attached.

---

## Menu Passwords

As with other keypanels, the KP-3016/3016A allows you to lock the entire menu structure or only the service menu. This is implemented through AZedit (System|Miscellaneous|Keypanel Menu Password). For more information, see the AZedit user manual (p/n F01U239453).

**NOTE:** Passwords can only include the digits 0-9.

Because the KP-3016/3016A does not have digit keys, passwords are entered by rotating the AUX/MENU shaft encoder to select a digit.

To **enter a menu password**, do the following:

1. Press the **MENU button**.  
*Password? appears in the keypanel display screen.*
2. Rotate the **AUX/MENU shaft encoder** to the first digit of the password.
3. Press the **SEL key**.  
OR  
Tap the **AUX/MENU shaft encoder**.  
OR  
Use the **left or right arrow keys** to move to the next digit.  
*The cursor moves to the next digit.*
4. Repeat **steps 2 and 3** until the entire password is entered.
5. Press SEL when the password is completely entered.  
*If the password is entered correctly, the menu appears.*

**NOTE:**

- Use the CLR button, double-click the AUX/MENU shaft encoder, or single-click the MAIN shaft encoder to erase the last digit.
- If there are no digits, the CLR button or double-click either the AUX/MENU or MAIN shaft encoder to exit the menu.

## Keypanel Color Window

The **Keypanel Color** window, shown in Figure 13, is used to change the text and background colors assigned to function types, key assignments, and talk/listen indications. You can modify local intercom key assignments and function type colors, as well as remote intercom function type colors, giving you the flexibility to distinguish different systems through the use of color patterns.

The Keypanel Color window is only available when the following requirements are met:

- running AZedit version 3.7.0 or later.
- running MCII-e version 2.1.0 or later.

**NOTE:** Key colors are associated with assignments and assignment types, not the physical keys they are assigned to.

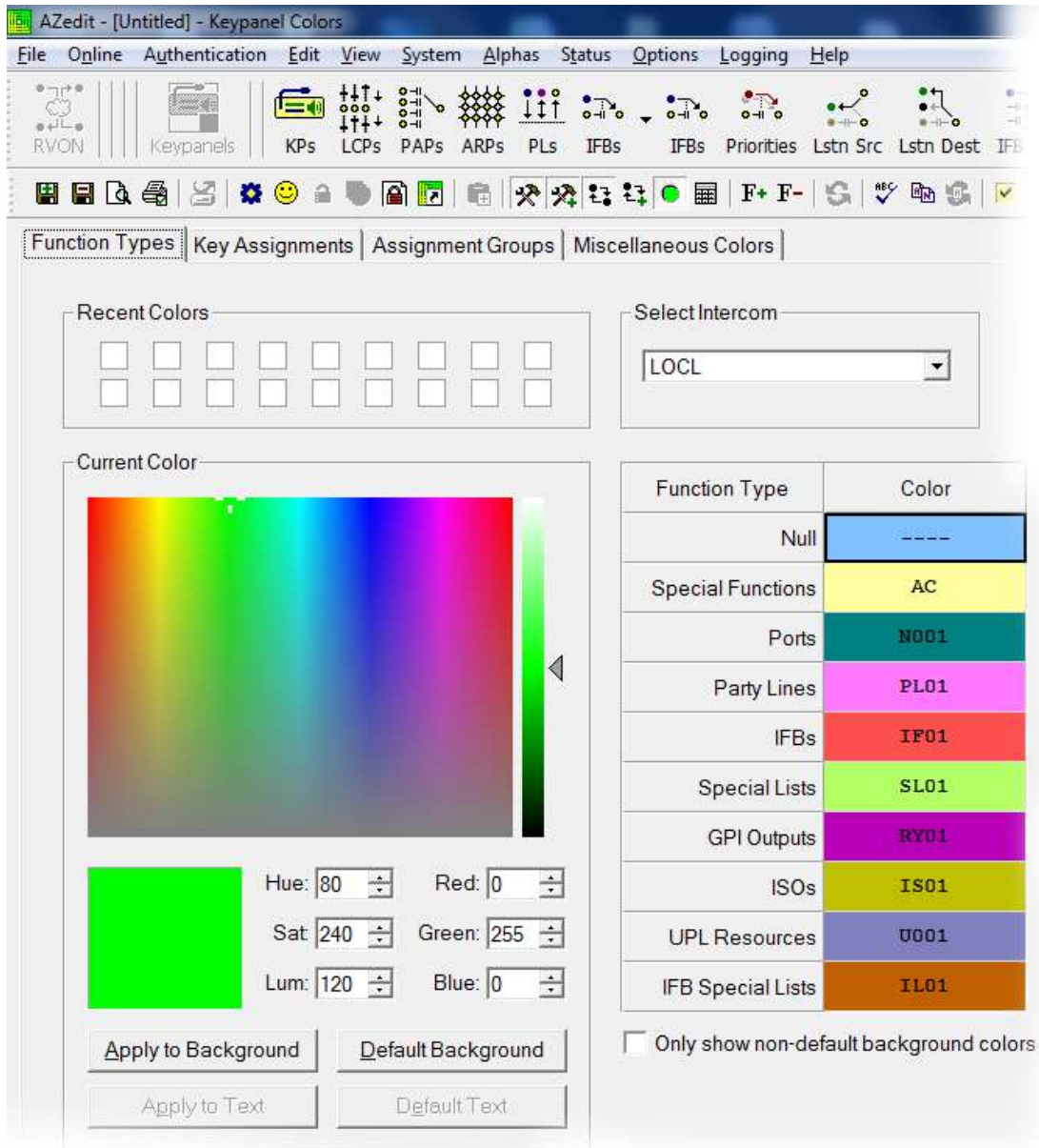

FIGURE 13. Keypanel Colors Window

---

## Function Types Page

The **Function Types** page, shown in Figure 13, is used to change the default colors assigned to the various keypad function types.

### *Select Intercom Drop Down Menu*

The **Select Intercom** drop down menu is used to select the intercom system (*local* or *remote*) in which you want to change the color of the key function types.

---

## Recent Colors Group Box

---

The **Recent Colors** group box displays the 18 most recently used colors.

---

## Current Color Group Box

---

The **Current Color** group box displays the currently selected color (current color cell), whether from the color palette or recent colors. Also, using the Hue, Sat, Lum, Red, Green, and/or Blue spin boxes, you can adjust the selected color to create a unique color for the function type.

**NOTE:** You can drag and drop colors from the color picker or recent color check boxes, and drop it on the background or text area of one (1) of the cells in the Color Grid (Figure 14 on page 51). You can also select a color in the Color Grid and drop and drag it to the Current Color Cell field. By holding down the Ctrl key on the keyboard, you can select multiple cells in the Color Grid, thus allowing you to apply color to multiple key assignments.

### *Apply To Background Button*

The **Apply to Background** button is used to apply the color selection to the background.

### *Default Background Button*

The **Default Background** button is used to reset the background color to the default color.

### *Apply To Text Button*

The **Apply to Text** button is used to apply the color selection to the text of the type of assignment.

### *Default Text Button*

The **Default Text** button is used to reset the text color to the default color of the type of assignment.



**Color Grid**

Function Type	Color
Null	----
Special Functions	<b>AC</b>
Ports	<b>H001</b>
Party Lines	<b>PL01</b>
IFBs	<b>IF01</b>
Special Lists	<b>SL01</b>
GPI Outputs	<b>RY01</b>
ISOs	<b>IS01</b>
UPL Resources	<b>U001</b>
IFB Special Lists	<b>IL01</b>

**FIGURE 14.** Color Grid

**Function Type Column**

The **Function Type** column displays the different function types you can make key color changes for.

Available selections are: *Null, Special Functions, Ports, Party Lines, IFBs, Special Lists, GPI Outputs, ISOs, UPL Resources, and IFB Special Lists.*

**Color Column**

The **Color** column displays the current text and background colors assigned to the function type.

**NOTE:** You must select the current color box next to the function type you want to change the color for. When selected, a thick black line appears around the box.

**Only Show Non-Default Background Colors Check Box**

The **Only Show Non-Default Background Colors** check box, if selected, shows colors only for function types set to a color other than their default color.

## Key Assignment Page

The **Key Assignment** page, shown in Figure 15, is used to change the colors assigned to the various assignment types. This means you can assign different colors to the individual function type resources. For example, you can change the display color for the party line assignment number 003.

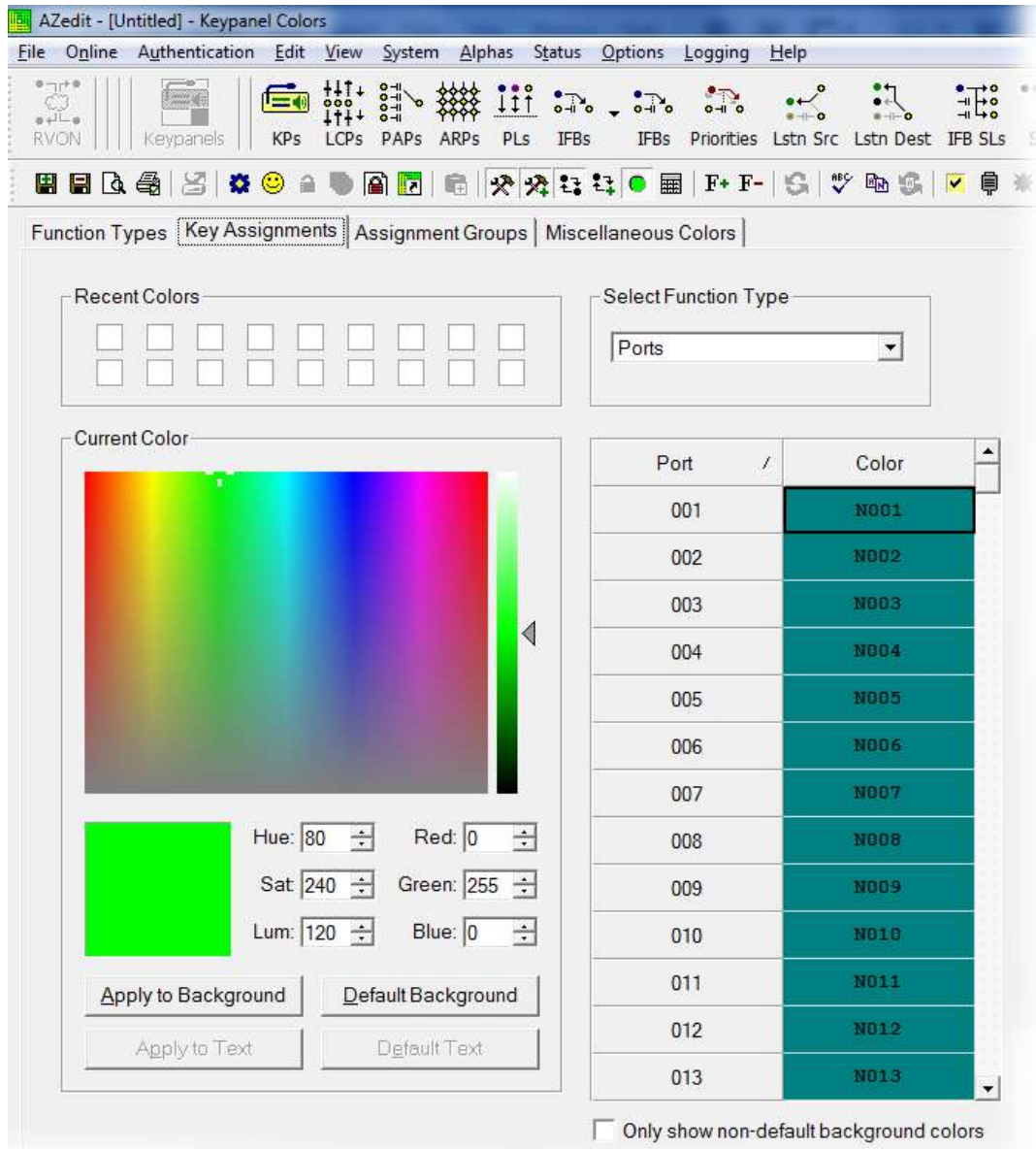

FIGURE 15. Key Assignments Page

### Select Function Type Drop Down Menu

The **Select Function Type** drop down menu is used to select the function type you want to display the function number resources for.

Available selections for this field are: *Ports*, *Party Lines*, *IFBs*, *Special Lists*, *GPI Outputs*, *ISOs*, *UPL Resources*, and *IFB Special Lists*.

**Function Number Column**

The **Function Number** column displays the function numbers (resources available) you can modify the color of the assigned key for.

**NOTE:** Key colors are associated with assignment types, not the keys they are assigned to.

**Color Column**

The **Color** column displays the current color assigned to the function number.

**NOTE:** You must select the current color box next to the function number you want to change the color for. When selected, a thick black line appears around the box indicating it is selected.

**Assignment Groups Page**

The **Assignment Groups** page, shown in Figure 16, is used to change colors of the members of the different assignment groups.

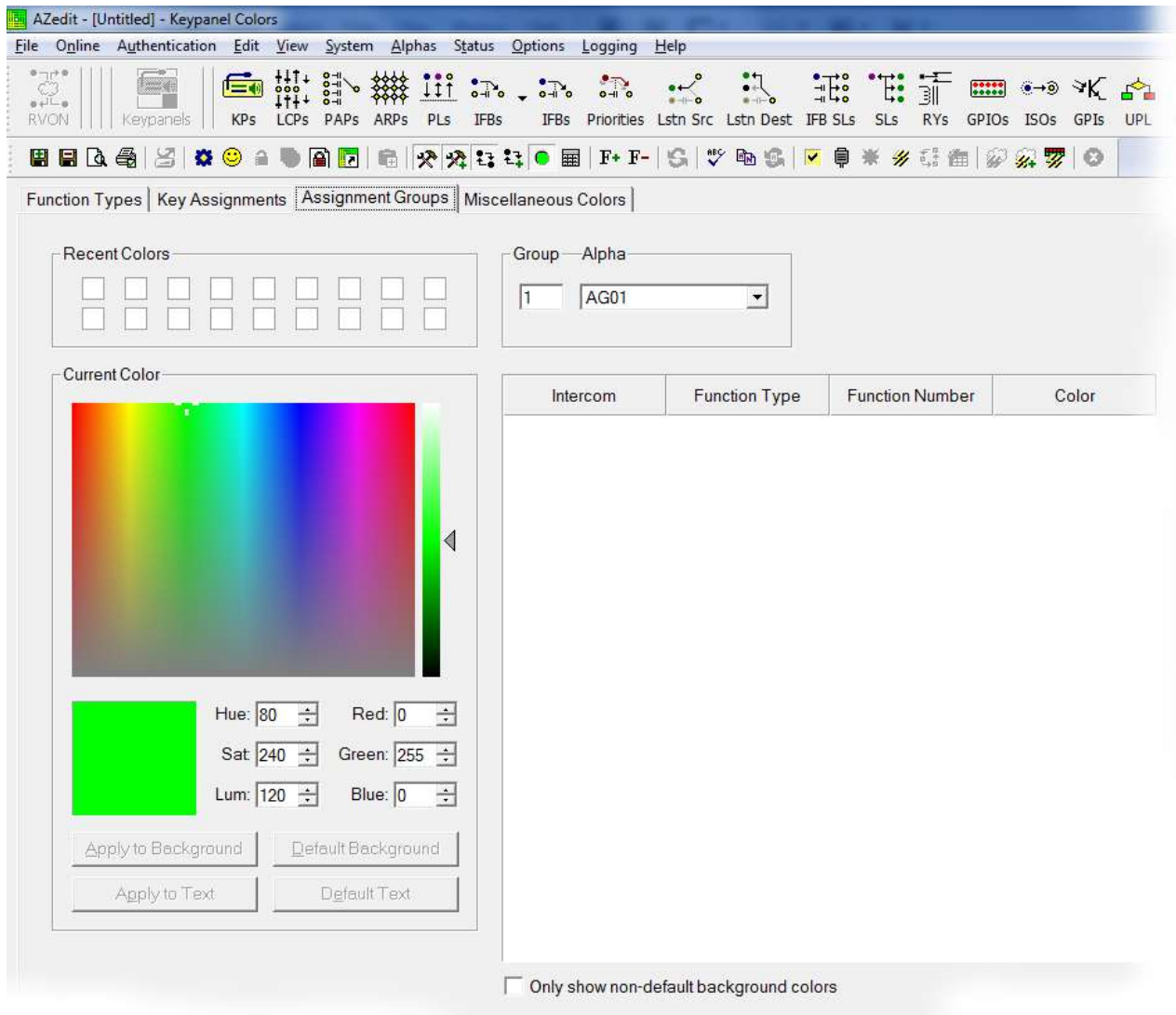

**FIGURE 16.** Assignments Groups Page

### ***Select Assignment Group Drop Down Menu***

The **Select Assignment Group** drop down menu is used to select the assignment group whose members you want to modify the key colors for.

### ***Intercom Column***

The **Intercom** column displays the name of the intercom where the group resides.

### ***Function Type Column***

The **Function Type** column displays the type function assigned to the group.

### ***Function Number Column***

The **Function Number** column displays the number of the assignment group you select from the Assignment Group drop down menu. For more information, see “Select Assignment Group Drop Down Menu” on page 54.

### ***Color Column***

The **Color** column is used to select the assignment group member you want to modify the associated color with.

To **select the color column**, do the following:

- > Click the **color box** next to the assignment group member.  
*A thick, black outline appears around the selected color box.*

### Miscellaneous Colors Page

The **Miscellaneous Colors** page, shown in Figure 17, is used to change the colors of the talk and listen indicators seen on the KP-3016/3016A series keypanel when talk and/or listen is activated.

For more information on Talk and Listen indicators, “Talk/Listen Indicator” on page 37.

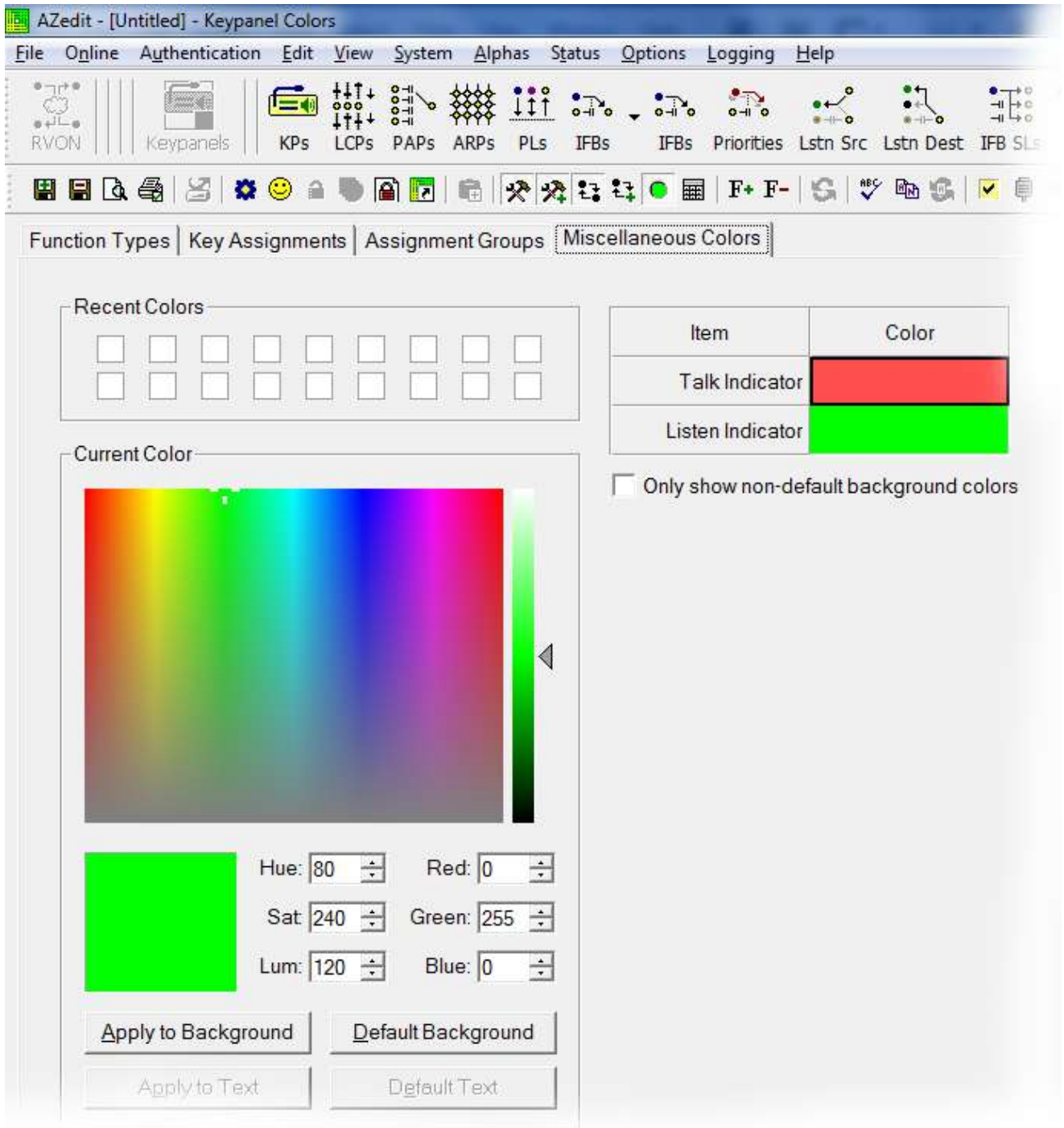

FIGURE 17. Miscellaneous Colors Page

## Enhanced Tallies

**Enhanced Tallies** allow you to configure, using AZedit, how tallies look on the keypad. You are able to change how incoming calls, PLs, IFBs, etc look on the keypad. By default, an incoming call tally is indicated by a flashing alpha. With enhanced tallies, you can configure the text and background colors used to display the key in both flashing and normal states for the duration of the tally. You can also configure a chime to be played when an incoming call is received, as well as an icon to appear announcing the call. For more information, see Table 8, “Tally Icon Descriptions,” on page 63.

### Requirements

AZedit version 5.0.0 or later

MCII-e version 3.2.0 or later

To **open the Enhanced Tallies window**, do the following:

1. Open **AZedit**.
2. From the menu bar, select **System**|**Miscellaneous**|**Enhanced Tallies**.  
*The Enhanced Tallies window appears.*

Tally #	Mode	Description	Duration	Characteristics	Chime #	Legacy Action
1	Flash Text	Incoming call	10 seconds	Text	<none>	Incoming Call Tally
2	No Tally	Extend call	Indefinite	Text	<none>	In Use Tally
3	Flash Text	Trunk in use	Indefinite	Text	<none>	In Use Tally
4	Flash Text	Trunk busy	Indefinite	Text	<none>	Busy Tally
5	Flash Text	IFB in use	Indefinite	Text	<none>	In Use Tally
6	Flash Text	IFB busy	Indefinite	Text	<none>	Busy Tally
7	Flash Text	PL in use	10 seconds	Text	<none>	Incoming Call Tally
8	Flash Text	General in-use	Indefinite	Text	<none>	In Use Tally
9	Flash Text	TIF off-hook	Indefinite	Text	<none>	In Use Tally
10	Flash Text	TIF ringing	Indefinite	Text	<none>	Busy Tally
11	No Tally	Tally #11			<none>	
12	No Tally	Tally #12			<none>	
13	No Tally	Tally #13			<none>	
14	No Tally	Tally #14			<none>	
15	No Tally	Tally #15			<none>	
16	No Tally	Tally #16			<none>	
17	No Tally	Tally #17			<none>	
18	No Tally	Tally #18			<none>	
19	No Tally	Tally #19			<none>	
20	No Tally	Tally #20			<none>	

**TABLE 6.** Enhanced Tallies Window

### Tally # Column

The **Tally #** column displays the tally number. This number is associated with the tally description and is used in selecting tallies to generate via UPL statements. AZedit supports 20 different tallies, however, the first 10 are predefined.

**TABLE 7.** Predefined Tallies

Tally #	Description
1	Incoming Call
2	Extend Call
3	Trunk in Use
4	Trunk Busy
5	IFB in Use
6	IFB Busy
7	PL in Use
8	General In Use
9	TIF Off-Hook
10	TIF Ringing

### Mode Column

The **Mode** column is used to select the type of tally to use.

There are three (3) options available:

*No Tally*

*Flash Text*           Flashes text for a user-determined (duration column) amount of time.

*Flash Icon*           Shows an icon for a user determined (duration column) amount of time. For more information, see Table 8, “Tally Icon Descriptions,” on page 63.

### Description Column

The **Description** column is used to enter a description of the tally you create.

---

**IMPORTANT:**       It is recommended you do not change the pre-defined tallies descriptions. Changing the description does not change pre-defined purpose of the tally. For example, if you change the description for IFB Busy to Trunk Busy, it still activates when an IFB is busy and may be confusing to users.

---

To **change the Description column**, do the following:

1. In the Description column, double-click the **tally description** you want to change.  
*The selected Description cell becomes active.*
2. In the cell, enter the **tally description** you want.

### Duration Column

The **Duration** column is used to select the duration the tally is activated for.

Available options for this field are: *Indefinite* and *one (1) second through five (5) minutes*.

To **set the tally duration**, do the following:

1. In the Duration column, select the **duration of the tally** you want to change.  
*A drop down menu appears.*
2. From the drop down menu, select the **desired duration**.

## Characteristics Column

The **Characteristics** column is used to configure the characteristics or behavior of the visual tally. Depending on what you select in the Mode column determines what is seen in this column. From the Characteristics column, you can access a configuration window for either Text or Icon selections. If No Tally is selected in the Mode column, the Characteristics column is blank.

To **open the Text configuration window**, do the following:

1. In the Characteristics column, click on the **cell with the word Text**.  
*The cell animates the tally as defined (for example, flashing text with color or animating icons) and an ellipsis button appears in the cell.*
2. Click the **Ellipsis button**.  
*The Flash Text Characteristics window appears. For more information, see “Flash Text Characteristics Window” on page 60.*

To **open the Icon configuration window**, do the following:

1. In the Characteristics column, click on the **cell with word Icon**.  
*An ellipsis button appears in the cell next to the word Icon.*
2. Click the **Ellipsis button**.  
*The Show Icon Characteristics window appears. For more information, see “Show Icon Characteristics Window” on page 62.*

## Chime # Column

The **Chime #** column is used to select the type of chime to play when a tally is activated.

Available options for this field are: *System Chime #1, System Chime #2, System Chime #3, and System Chime #4.*

To **set the chime**, do the following:

1. In the Chime # column, select the **chime cell** you want to change.  
*A drop down menu appears.*
2. From the drop down menu, select the **desired chime**.

## Duration Column

The **Duration** column is used to select the length of time to for the chime to last.

Available options for this field are: *One-shot and one (1) second through five (5) minutes.*

To **set the duration of the chime**, do the following:

1. In the Duration column, select the **duration of the tally** you want to change.  
*A drop down menu appears.*
2. From the drop down menu, select the **desired duration**.



### Legacy Action Column

The **Legacy Action** column is used to select how the tally descriptions is implemented on keypanels that do not support Enhanced Tallies.

Available options are:

- No Tally*
- Incoming Call Tally*
- In-Use Tally*
- Busy Tally*

To **select a legacy action**, do the following:

1. Click in the **Legacy Action column cell** desired.  
*A drop down arrow appears.*
2. From the Legacy Action drop down menu, select **desired action**.

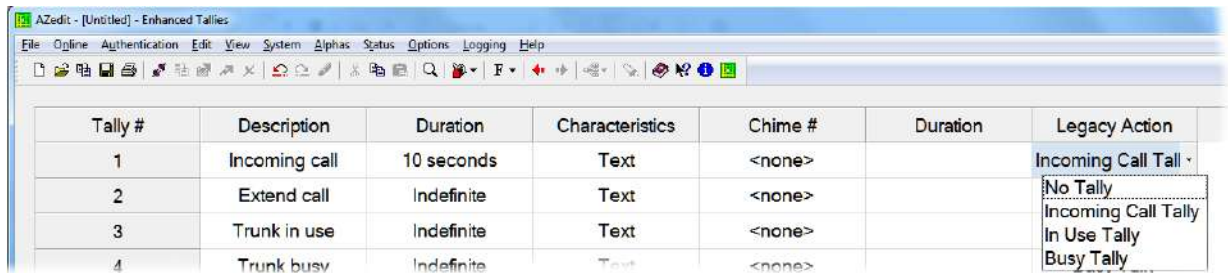

## Flash Text Characteristics Window

The **Flash Text Characteristics** window is used to configure the way a text tally behaves for the selected tally.

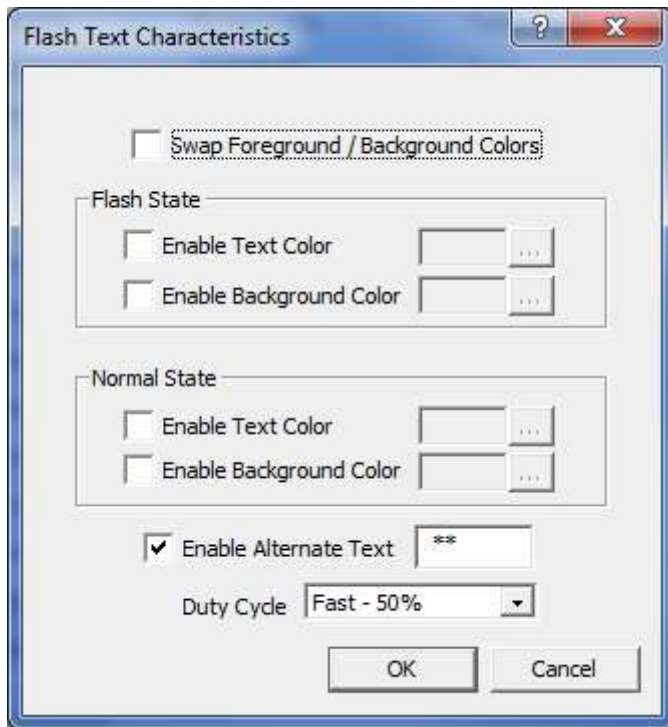

FIGURE 18. Flash Text Characteristics Window

### Swap Foreground / Background Colors Check Box

The **Swap Foreground / Background Colors** check box indicates the foreground color swaps with the background color creating a blinking effect on the keypad display.

### Flash State Group Box

The **Flash State** group box is used to assign text and background colors used when a tally state is flashing.

#### Enable Text Color Check Box

The **Enable Text Color** check box enables the Selected Color cell and Browse button. This means you can modify the color of the Text displayed.

#### Selected Color Cell and Ellipsis Button

The **Selected Color** cell displays the currently selected color of the text.

The **Ellipsis** button opens the Select Color window where you can assign a different color to the text.

#### Enable Background Color Check Box

The **Enable Background Color** check box enables the Selected Color cell and Browse button. This means you can modify the color of the Background displayed.

***Selected Color Cell and Ellipsis Button***

The **Selected Color** cell displays the currently selected color of the background.

The **Ellipsis** button opens the Select Color window where you can assign a different color to the background.

**Normal State Group Box**

The **Normal State** group box is used when the tally is active and is not in the flash state. If there is no tally active, then the colors are whatever is defined for the assignment in the intercom.

***Enable Text Color Check Box***

The **Enable Text Color** check box enables the Selected Color cell and Browse button. This means you can modify the color of the Text displayed.

***Selected Color Cell and Ellipsis Button***

The **Selected Color** cell displays the currently selected color of the text.

The **Ellipsis** button opens the Select Color window where you can assign a different color to the text.

***Enable Background Color Check Box***

The **Enable Background Color** check box enables the Selected Color cell and Browse button. This means you can modify the color of the Background displayed.

***Selected Color Cell and Ellipsis Button***

The **Selected Color** cell displays the currently selected color of the background.

The **Ellipsis** button opens the Select Color window where you can assign a different color to the background.

**Enable Alternate Text Check Box and Entry Field**

The **Enable Alternate Text** check box and entry field is used to enter alternate text or characters that appears intermittently with the existing tally text.

This field can contain up to four (4) characters.

**Duty Cycle Drop Down Menu**

The **Duty Cycle** drop down menu is used to select the rate the tally flashes alternate with normal text mode. The flash period is one (1) second.

Available options for this menu are:

- On Solid*                      There is no flash
- Slow 25%*                      The flash appears for 25% of the flash period (1/4 of a second), while the normal mode appears for 75% of the flash period (3/4 of a second)
- Slow 50%*                      The flash and the normal mode appear for 50% of the flash period (1/2 second each)
- Fast 50%*                      The flash and the normal appear for 50% of the flash period in alternating pattern (1/4 second flash, 1/4 second normal mode, 1/4 second flash, and 1/4 second normal mode)
- Fast 75%*                      The flash appears for 75% (3/4 of a second), while the existing text appears for 25% (1/4 if a second) of the flash period

### OK Button

The **OK** button is used to accept/apply the changes and close the window.

### Cancel Button

The **Cancel** button is used to reject the changes and close the window.

---

## Show Icon Characteristics Window

The **Show Icon Characteristics** window is used to configure which icon to display during a tally event and the rate at which it flashes during the event.

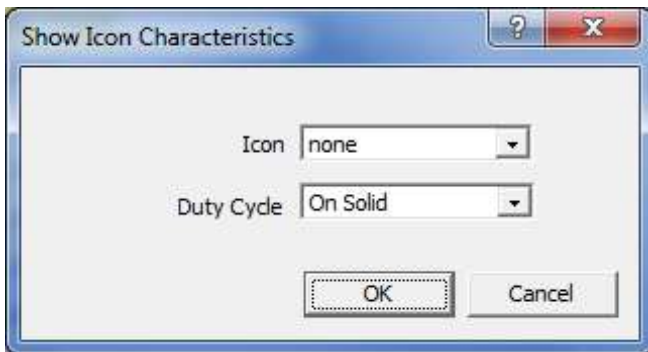

**FIGURE 19.** Show Icon Characteristic Window

### Icon Drop Down Menu

The **Icon** drop down menu is used to select the icon you desire. See “Tally Icon Descriptions” on page 63

### Duty Cycle Drop Down Menu

The **Duty Cycle** drop down menu is used to select the rate the icon flashes. The flash period is 1 second.

Available options for this menu are:

<i>On Solid</i>	There is no flash
<i>Slow 25%</i>	The icon appears for 25% of the slow flash period
<i>Slow 50%</i>	The icon appears for 50% of the slow flash period
<i>Fast 50%</i>	The icon appears for 50% of the fast flash period in alternating 25% segments
<i>Slow 75%</i>	The icon appears for 75% of the fast flash period
<i>Animate</i>	4-frame animation, each frame displays for 25% of the flash period.

### OK Button

The **OK** button is used to accept/apply the changes and close the window.

### Cancel Button









The **Cancel** button is used to reject the changes and close the window.

### Enhanced Tally Icons













**Enhanced Tally Icons**, shown in Table 8, are used to visually alert keypad users of different events occurring on the keypad and in the Matrix system. The keypad ships with these icons built-in by default. However, you can download new icons to the panel using AZedit.

**NOTE:** These icons are the default icons included with the keypad. These icons can be used for any purpose. Not all the icons are used as defaults. The descriptions in Table 8 are just suggested uses.

**TABLE 8.** Tally Icon Descriptions

Icon	Icon Name	Description
	Target	Incoming Call (animation supported) – A call is coming into the keypad and the animation toggles the target every half second. Extended Call (animation not supported)– The extended call tally is generated when the key is on for a predetermined amount of time. In English intercoms, five (5) seconds pass before the tally begins, while in Japanese intercoms, two (2) seconds must pass
	Red Star	Trunk In-Use (animation not supported) Trunk Busy (animation supported) – The trunk is busy. The animation toggles the star on/off every quarter of a second.
	Black Star	IFB/ISO In Use (animation not supported) IFB/ISO Busy (animated) - The IFB/ISO is busy. The animation rotates the star.
	Orange Wave	PL In-Use (animation not supported)
	Gray Gear	General In-Use (animation not supported) - Used in Japanese intercoms. This tally is used to show when other keypads are doing an action on the keypad. In a Japanese intercom, if your panel is in-use (i.e., you turn on a talk key to anybody), and I have your assignment on my keypad, the assignment on my keypad displays the General In-Use tally, even though we are not talking to each other.
	Red Phone	TIF Ringing (animation supported) - The handset vibrates in the animation.
	Yellow Phone	TIF Offhook (animation supported) - The TIF key is active. The animation flashes the icon on and off every half second.
	Exclamation	Available for UPL Tally (animation supported) - The animation flashes the icon on and off every half second.
	Heart	Available for UPL Tally (animation supported) - The animation flashes the icon on and off every half second.

**TABLE 8.** Tally Icon Descriptions

Icon	Icon Name	Description
	Question	Available for UPL Tally (animation supported) - The animation flashes the icon on and off every half second.
	Flag	Available for UPL Tally (animation supported) - The animation flashes the icon on and off every half second.
	Person	Available for UPL Tally (animation supported) - The animation flashes the icon on and off every half second.
	Link	Available for UPL Tally (animation supported) - The animation flashes the icon on and off every half second.
	Car	Available for UPL Tally (animation supported) - The animation flashes the icon on and off every half second.
	Lightening Bolt	Available for UPL Tally (animation supported) - The animation flashes the icon on and off every half second.
	House	Available for UPL Tally (animation supported) - The animation flashes the icon on and off every half second.
	Handset	Available for UPL Tally (animation supported) - The animation flashes the icon on and off every half second.
	Lock	Available for UPL Tally (animation not supported)
	Speaker	Available for UPL Tally (animation supported) - The animation flashes the icon on and off every half second.
	Play	Available for UPL Tally (animation supported) - The animation flashes the icon on and off every half second.
	Message	Available for UPL Tally (animation supported) - The animation flashes the icon on and off every half second.
	Red Circle	Available for UPL Tally (animation supported) - The animation flashes the icon on and off every half second.

### Tally (Key Overlays)

To create your own tally icons (key icons), the icons are 16x16 pixels. 32 key icons are supported, as well as 4-frame animation, so the bitmap must be 512x64, producing a table of 32x4 icons (each icon 16x16 pixels), see Figure 20. AZedit accepts a narrower image (as long as it is a multiple of 16) and uses white space to fill in the missing pixels. Shorter images are supported (as long as the image is either 16 or 32 pixels tall) and is replicated (3 times, or once) to get an image measuring 64 pixels tall.



FIGURE 20. Tally (key) icon 512x64 pixel bitmap of key icons

### Panel Tally

**Panel Tally** is used to notify a keypanel user of an event not specifically belonging to a key; for example, a blinking icon appears when a newscast is on air. Panel tallies are controlled through the use of UPL statements. Multiple UPL statements can be configured, but only one (1) icon displays at a time. Lower numbered icons take priority.

**NOTE:** The keypanel ships with these icons built-in by default. However, you can download new icons to the panel using AZedit.

Available panel tally icons are:

### Suggested Use



Alarm, Appointment, Event



Positive, Notify



Alarm, Chime, Notify



Favorite



Target, Incoming



Information



Appointment, Event



Negative



On-Air, Live



On Air



Error



Warning, Alarm, Alert



Warning

### Panel Icons

For panel icons, the icons are 32x32 pixels. 16 panel icons are supported, as well as 4-frame animation, so the bitmap must be 512x128, producing a table of 16x4 icons (each icon 32x32 pixels), see Figure 21. Like key icons, AZedit accepts a narrower image (as long as it is a multiple of 32) and uses white space to fill in the missing pixels. Shorter images are supported (as long as the image is either 32 or 64 pixels tall) and replicates (3 times, or once) to get an image measuring 128 pixels tall.

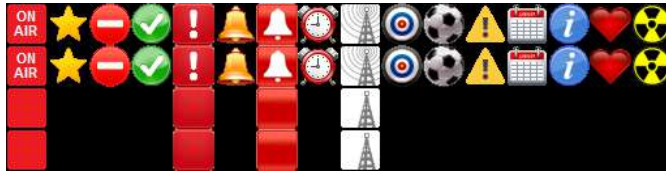

FIGURE 21. 512 x128 pixel bitmap of panel icons





## Firmware Download

### Download Firmware to the KP-3016/3016A From AZedit

**IMPORTANT:** When downloading firmware using AZedit, the file type used is a .mot file. When downloading firmware using the Firmware Upload Tool, the file type is a .capfw file.

To **download firmware to the keypanel**, do the following:

1. Open **AZedit**.
2. From the Status menu, select **Port**.  
*The Port Status window appears.*
3. Find the **port number** where the KP-3016/3016A is connected.

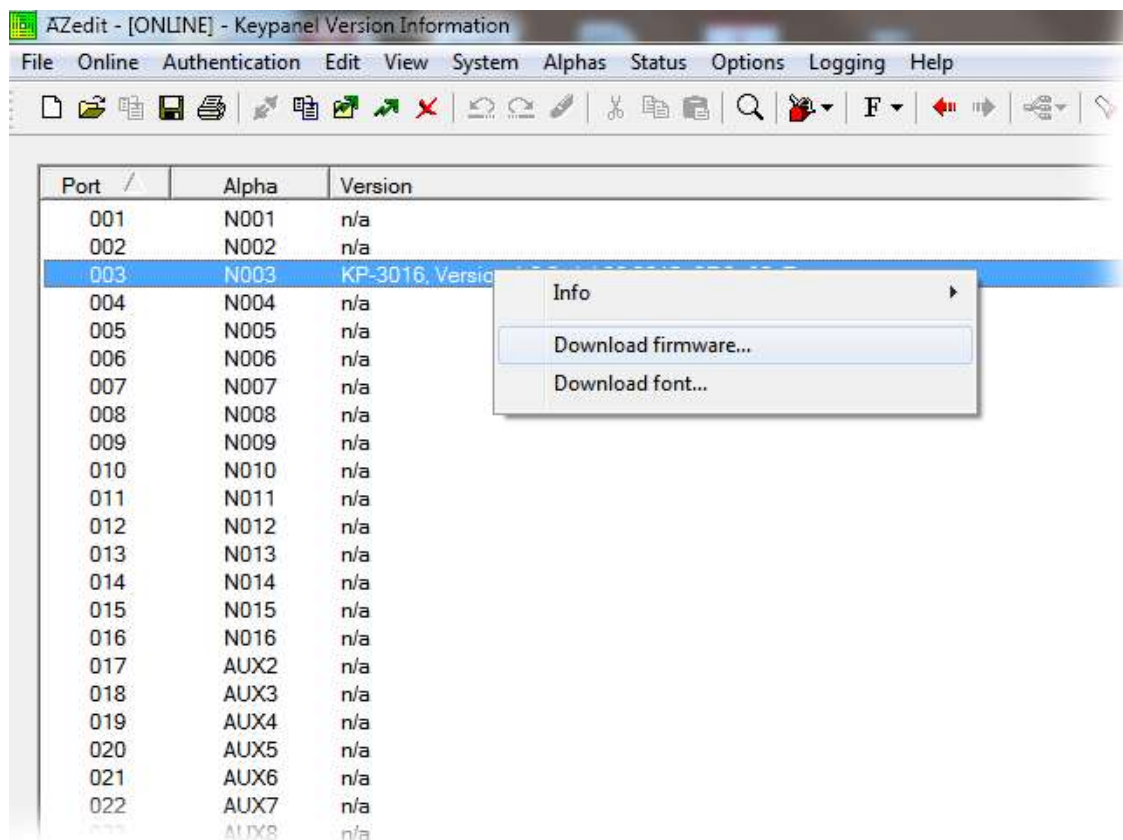

4. Highlight the **Port** (keypanel) to be updated.  
*You may select more than one (1) at a time by holding CTRL key down while you select.*
5. Right-click the **highlighted selections**.  
*A popup menu appears.*
6. Select **Download firmware....**  
*The Firmware Download window appears.*
7. Using the browse button, browse to the **file to be downloaded**.
8. Click **Open**.  
*The Download Device Firmware window appears.*



9. Click **Begin Download**.  
*The download begins.*

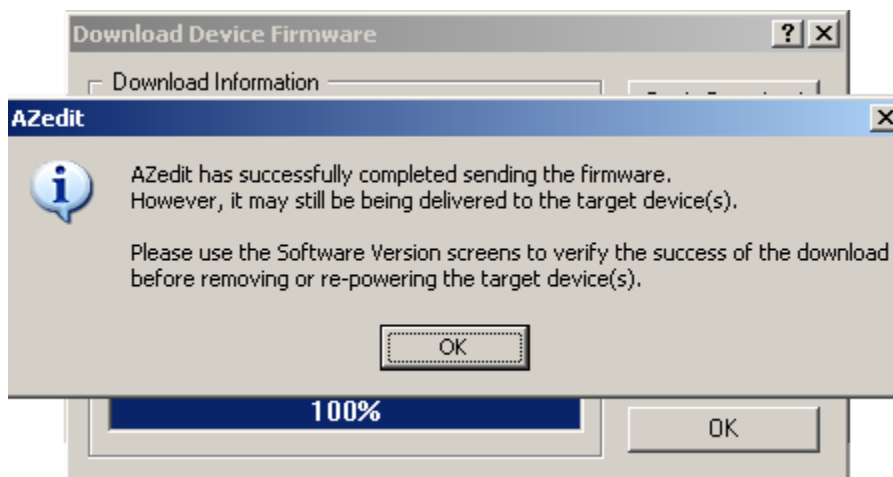

10. Click **OK**.  
*The KP-3016/3016A firmware download finishes.*
11. Verify the keypanel displays the **Processing Download icon with progression bar**.

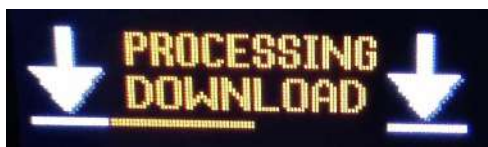

**NOTE:**

- This can take up to 2 minutes to complete if connected via OMNEO and up to 15 minutes to complete if connected via AIO. Use the Keypanel Version Information window to follow the progress of the download. Also, the keypanel displays Firmware Download on the panel display until the download is complete.
  - The KP-3016/3016A resets itself once the firmware download is complete and the flash reprogrammed.
  - While the firmware is downloading, chunk progress is displayed by incremental blocks. Also, the keypanel displays an icon warning not to turn off the panel while the flash is being reprogrammed.
12. In the Keypanel Version Information window, verify the **version upgrade**.

Port	Alpha	Version
001	N001	n/a
002	N002	n/a
003	N003	KP-3016, Version 1.0.3, Jul 30 2015, CRC=92c7
004	N004	n/a
005	N005	n/a
006	N006	n/a

*Download Firmware to the Keypanel Using the Firmware Upload Tool*

Required Firmware version:

*FWUT*                                      *V3.0.3 or later*

---

**IMPORTANT:**      When downloading firmware using AZedit , the file type used is a .mot file. When downloading firmware using the Firmware Upload Tool, the file type is a .capfw file.

---

To **download firmware to the keypanel**, do the following:

1. Open the **Firmware Upload Tool**.

2. From the File menu, select **Options**.  
The *Firmware Upload Tool Options* window appears.

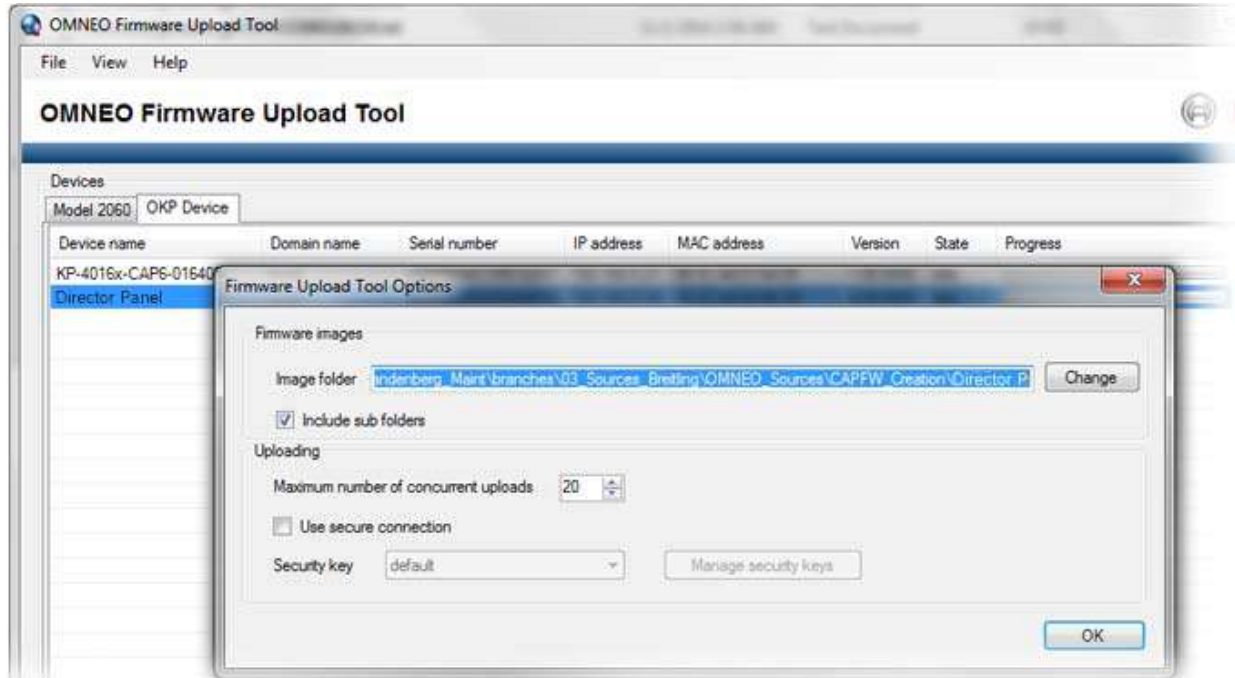

3. Click the **Change** button.  
The *folder network* window appears.
4. Navigate to the **folder** where the firmware resides.
5. Click **OK**.
6. Click **OK**, again.  
The *Firmware Upload Tool Options* window closes.
7. From the OKP Device page, select the **device** you want to update.

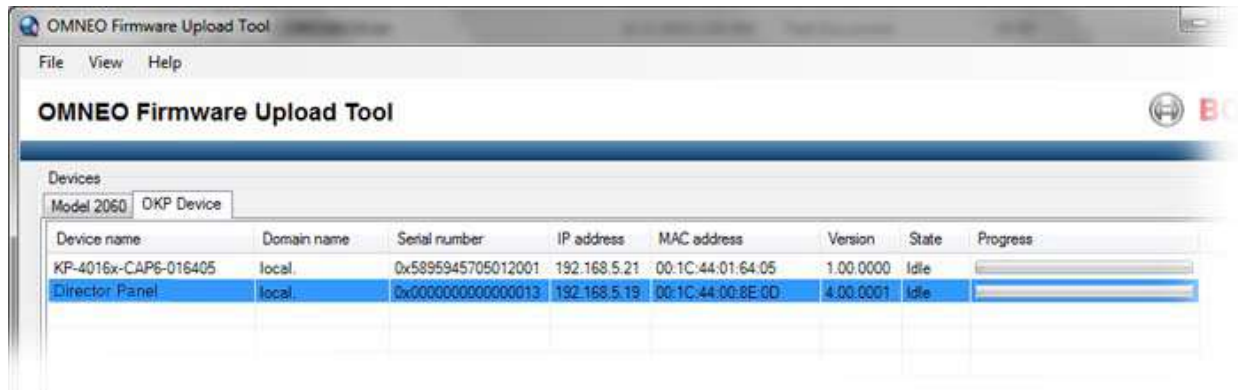

8. Click the **Upload** button.  
The *Select Firmware for Upload* window appears.

- From the list of firmware, select the **firmware** you want to download.

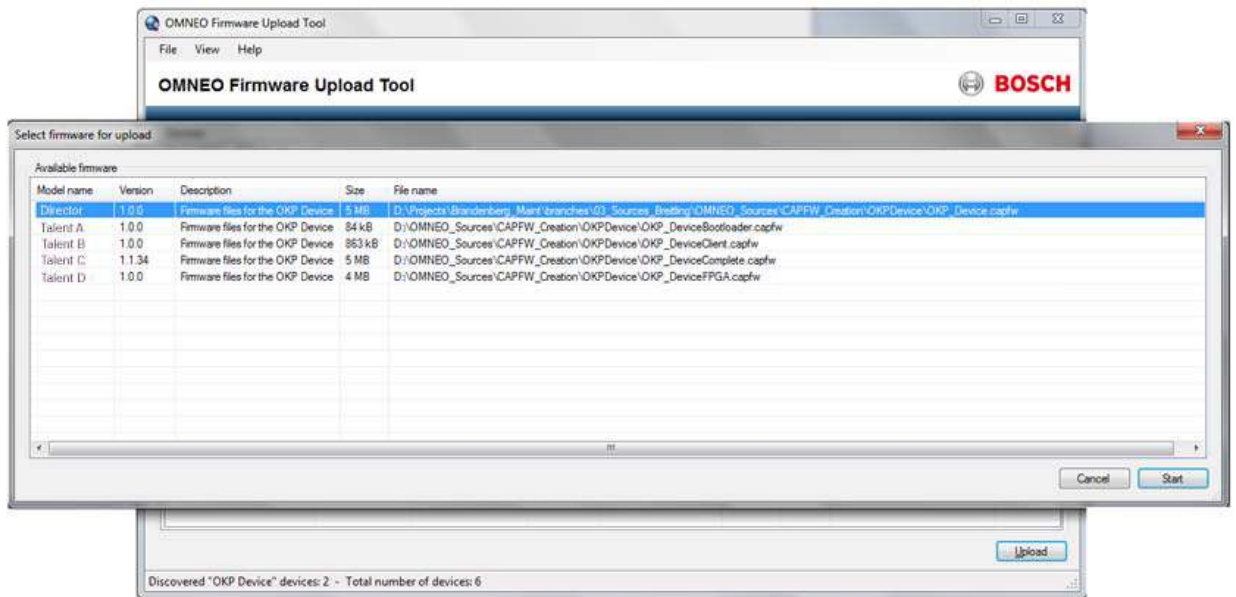

- Click the **Start** button.
- Once the firmware has been updated, the keypanel **reboots** automatically.

## Download Firmware Using the Bootloader

The **Bootloader** is used to upload a new bootloader image or to upgrade the keypanel firmware if it is corrupt or fails in such a way that makes normal downloading of new firmware impossible.

**IMPORTANT:** If the keypanel firmware is corrupt, the panel may boot automatically into the bootloader. However, if the keypanel firmware appears valid, but fails to run properly, you may need to force the keypanel into the bootloader to load new keypanel firmware. You can also force the keypanel into the bootloader in order to download a new bootloader image (though this can also be done through the keypanel firmware, see “Enable Downloading New Bootloader from the Keypanel” on page 74.

### Run the Bootloader

To **run the bootloader**, do the following:

1. Power **off** the keypanel.
2. Verify the **KP-3016/3016A is powered off**, but still connected to the FRAME.
3. At the same time, press and hold **keypanel key 15 in the listen position (up) and keypanel key 16 in the talk position (down)**, while you connect the **power cord** to the keypanel.

*KP-3016/3016A - Boot Loader Waiting for download... appears in the panel display.*



4. In AZedit, from the Status menu, select **Software Versions**.  
*The Software Versions popup menu appears.*
5. From the Software Versions popup menu, select **Keypanels**.  
*The Keypanel Version Information window appears.*

Port	Alpha	Version
122	122	n/a
123	123	n/a
124	124	n/a
125	125	n/a
126	126	n/a
127	127	n/a
128	128	n/a
129	129	n/a
130	130	n/a
131	131	n/a
132	132	n/a
133	133	n/a
134	134	n/a
135	135	n/a
136	136	KP-3016 BOOT LOADER, VERSION 1.1.0, JUL 30 2015, CRC=2337
137	N137	n/a
138	N138	n/a

6. From the Keypanel Version Information window, find and select the **specified KP-3016/3016A**.
7. Right-click on the **KP-3016/3016A**.  
*A popup menu appears.*
8. From the popup menu, select **Download Firmware...**  
*The Firmware Download navigation window appears.*
9. Navigate to and select your **firmware file** (i.e., KP-Series\_client\_z.mot).
10. Click **Open**.  
*The Download Device Firmware window appears.*



11. Click **Begin Download**.  
*The Download begins and a popup message appears.*
12. Click **OK**.  
*The KP-3016/3016A firmware download finishes.*

**NOTE:** This can take up to 15 minutes to complete if connected via AIO. Use the Keypanel Version Information window to follow the progress of the download (the number and percentage of chunks completed). Also, the firmware progression is displayed on the KP-3016 panel display until the download is complete.

**NOTE:** Once the Boot Loader is finished downloading, it reprograms the flash and reboots itself.



---

## Enable Downloading New Bootloader from the Keypanel

Once you have enabled the keypanel to allow the firmware to be downloaded to it, you can use AZedit to configure the keypanel.

To **enable bootloader firmware downloads on the keypanel**, do the following:

1. While pressing the Main Vol and Aux Vol encoders on the front of the keypanel at the same time, press the **MENU button**.  
*The main menu appears in the panel display.*
2. Using the AUX/MENU shaft encoder, select **Service**.
3. Press the **SEL button**.  
*The Service menu options appear in the panel display.*
4. Using the AUX/MENU shaft encoder, select **Boot Code**.
5. Press the **SEL button**.  
*Allow Download and Version X.X.X (where X represents version numbers) appears in the panel display.*
6. Using the AUX/MENU shaft encoder, select **Allow Download**.
7. Press the **SEL button**.  
*The keypanel now allows firmware downloads.*

If the keypanel is powered off or loses power, the state of the Allow Download option resets to not enabled. You must reconfigure the option for it to allow new bootloader firmware to be downloaded.

---

## Display the FPGA Version

To **display the FPGA version currently installed in the keypanel**, do the following:

1. While pressing the Main Vol and Aux Vol/MENU encoders on the front of the keypanel at the same time, press the **MENU button**.  
*The main menu appears in the panel display.*
2. Using the AUX/MENU shaft encoder, select **Service**.
3. Press the **SEL button**.  
*The Service menu options appear in the panel display.*
4. Using the AUX/MENU shaft encoder, select **FPGA Version**.
5. Press the **SEL button**.  
*Version X.X.X (where X represents the FPGA version numbers) appears in the panel display.*

---

## Download and Upgrade the FPGA in the KP-3016/3016A

To **download the FPGA to the keypanel**, do the following:

1. Open **AZedit**.
2. From the Status menu, select **Software Versions|Keypanels**.  
*The Keypanel Version Information window appears.*
3. Find the **port number** where the KP-3016/3016A is assigned.
4. Highlight the **Port** (keypanel) to be updated.  
*You may select more than one (1) at a time by holding CTRL key down while you select.*
5. Right-click the **highlighted selections**.  
*A popup menu appears.*



6. Select **Download Firmware**.  
*The Firmware Download window appears.*
7. Using the browse button, navigate to the **FPGA file** you want to use.
8. Click **Open**.  
*The Download Device Firmware window appears.*

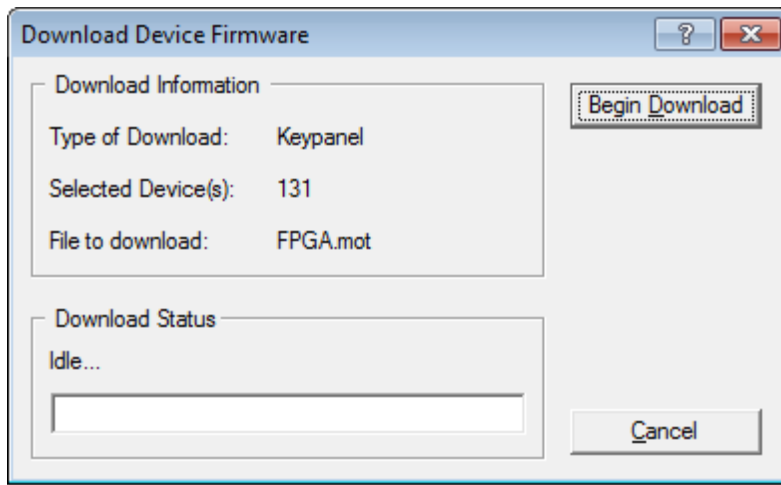

9. Click **Begin Download**.  
*The download begins. A progress bar appears to show the progress of the download.*
10. Click **OK**.  
*The KP-3016/3016A firmware download to the Matrix finishes. The Download FPGA Firmware To The Keypanel begins.*

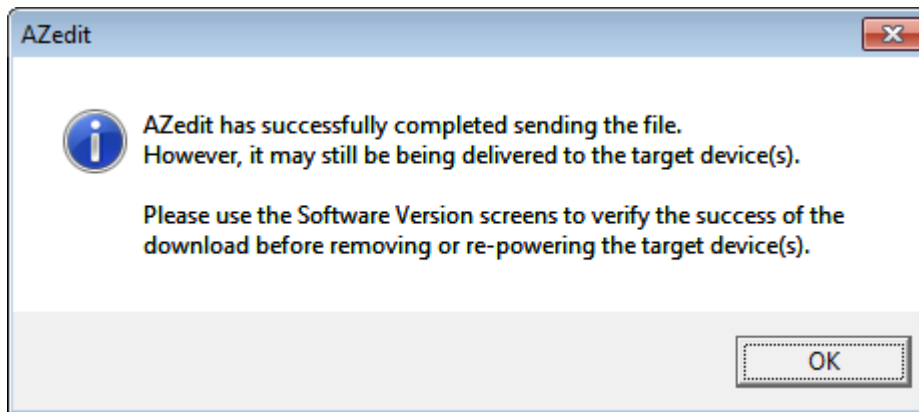

11. Verify the Keypanel Version Information window is displaying the **numbers of chunks (of data) transferred to the keypanel**.

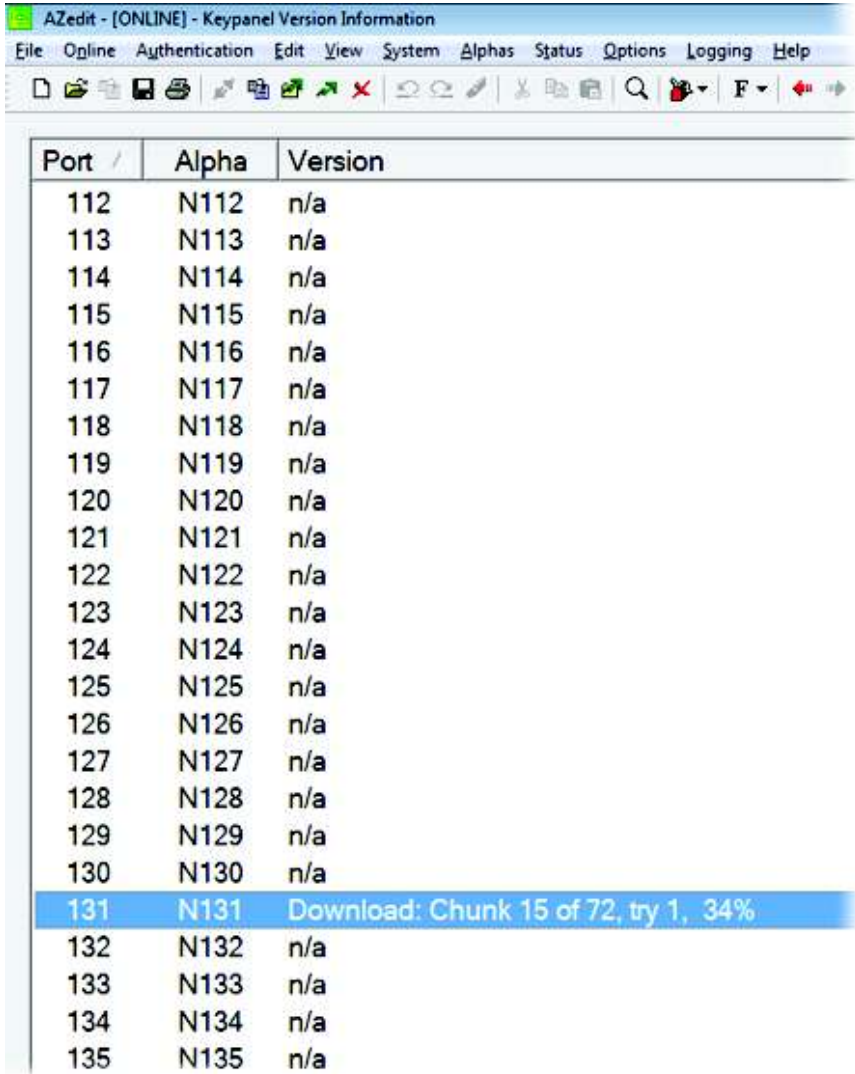

Port /	Alpha	Version
112	N112	n/a
113	N113	n/a
114	N114	n/a
115	N115	n/a
116	N116	n/a
117	N117	n/a
118	N118	n/a
119	N119	n/a
120	N120	n/a
121	N121	n/a
122	N122	n/a
123	N123	n/a
124	N124	n/a
125	N125	n/a
126	N126	n/a
127	N127	n/a
128	N128	n/a
129	N129	n/a
130	N130	n/a
131	N131	Download: Chunk 15 of 72, try 1, 34%
132	N132	n/a
133	N133	n/a
134	N134	n/a
135	N135	n/a

12. Verify the keypanel displays the **FPGA Downloading icon with progression bar**.  
*Once the download is complete, the keypanel has to process the downloaded file.*



- Verify the Keypanel Version Information window displays **Processing download** on the keypanel port you chose.

Port /	Alpha	Version
118	N118	n/a
119	N119	n/a
120	N120	n/a
121	N121	n/a
122	N122	n/a
123	N123	n/a
124	N124	n/a
125	N125	n/a
126	N126	n/a
127	N127	n/a
128	N128	n/a
129	N129	n/a
130	N130	n/a
131	N131	Processing download
132	N132	n/a
133	N133	n/a
134	N134	n/a

- Verify the keypanel displays the **Processing Download icon with progression bar**.



- Once the keypanel is finished processing the download, the keypanel begins to **reprogram**.  
*The keypanel flashes a Reprogramming: Do Not Turn Off icon in the display panel. This can take several minutes.*



- Once the reprogramming is complete, the keypanel **reboots**.

---

### Download a Splash Screen

---

**IMPORTANT:** The maximum bitmap size is 576x90. If the bitmap is smaller than the full screen dimensions, the keypanel centers the bitmap horizontally and vertically on the display and fills the background with the same color as the pixel in the top left corner of the splash screen.

---

- Open **AZedit**.
- From the Status menu, select **Software Versions|Keypanels**.  
*The Keypanel Version Information window appears.*
- Find the **port number** where the KP-3016/3016A is assigned.
- Highlight the **Port** (keypanel) to be updated.  
*You may select more than one (1) at a time by holding CTRL key down while you select.*
- Right-click the **highlighted selections**.  
*A popup menu appears.*

6. Select **Download splash screen...**  
*The Splash Screen Download window appears.*
7. Click **Open**.  
*The Download Splash Screen File window appears.*

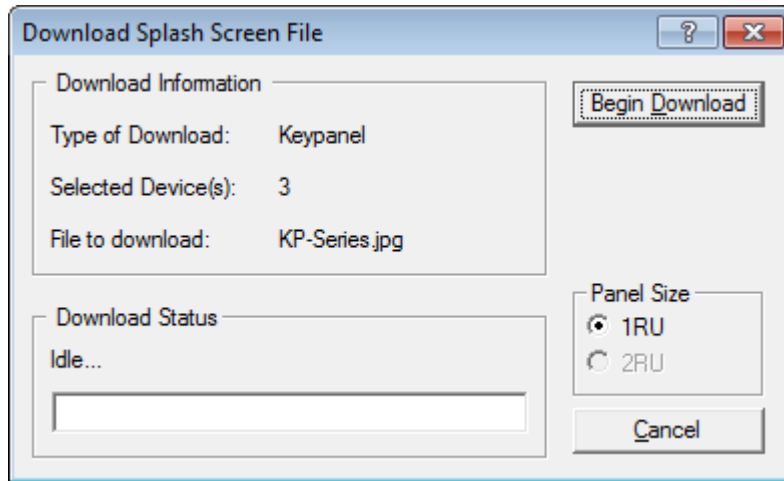

8. In the Panel Size group box, select the 1RU radio button.
9. Click **Begin Download**.  
*The download begins. A progress bar appears to show the progress of the download. Once the download is complete the Download Splash Screen File window closes.*
10. Verify the Keypanel Version Information window is displaying the **numbers of chunks (of data) transferred to the keypanel**.

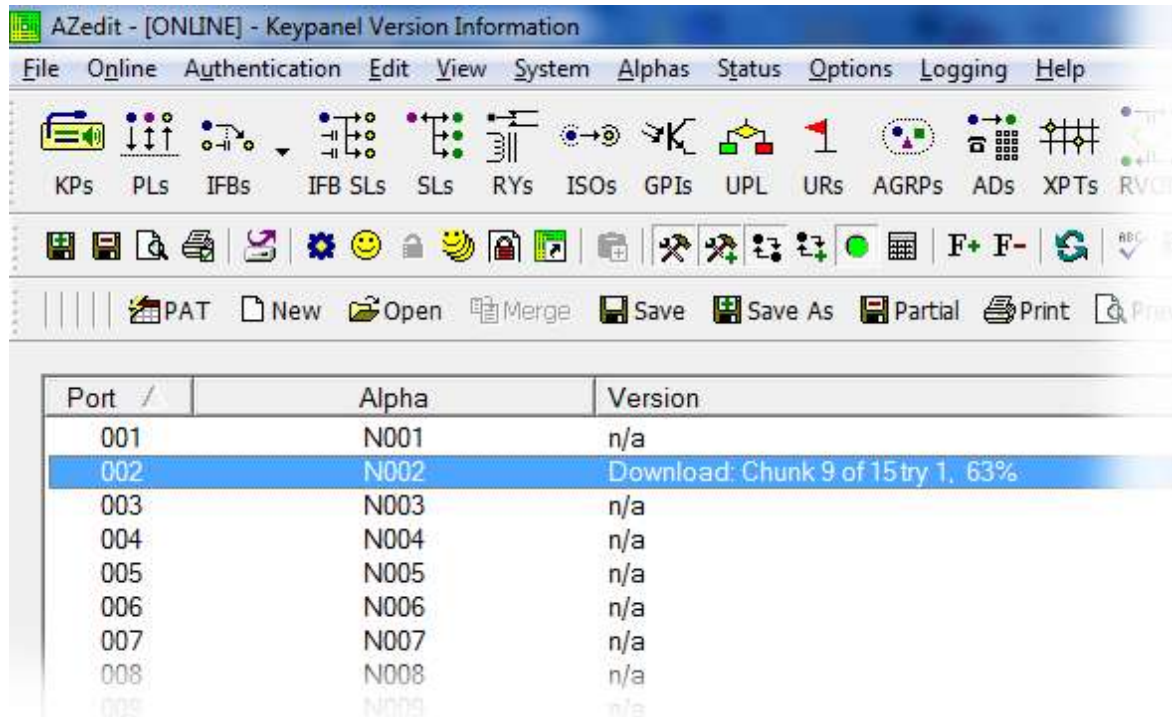

- Verify the keypanel displays the **Splash Screen Downloading icon with progression bar**.  
Once the download is complete, the keypanel has to process the downloaded file.



- Once the keypanel is finished processing the download, the keypanel begins to **reprogram**.  
The keypanel flashes a **Reprogramming: Do Not Turn Off** icon in the display panel. This can take several minutes.



- Once the reprogramming is complete, the keypanel **reboots**.

### Download a Font File

- Open **AZedit**.
- From the Status menu, select **Software Versions|Keypanels**.  
The *Keypanel Version Information* window appears.
- Find the **port number** where the KP-3016/3016A is assigned.
- Highlight the **Port** (keypanel) to be updated.  
You may select more than one (1) at a time by holding CTRL key down while you select.
- Right-click the **highlighted selections**.  
A *popup menu* appears.
- Select **Download font...**  
The *Font Download* window appears.
- Navigate to the **font file (.kpf)** you want to use.
- Click **Open**.  
The *Download Keypanel Font* window appears.

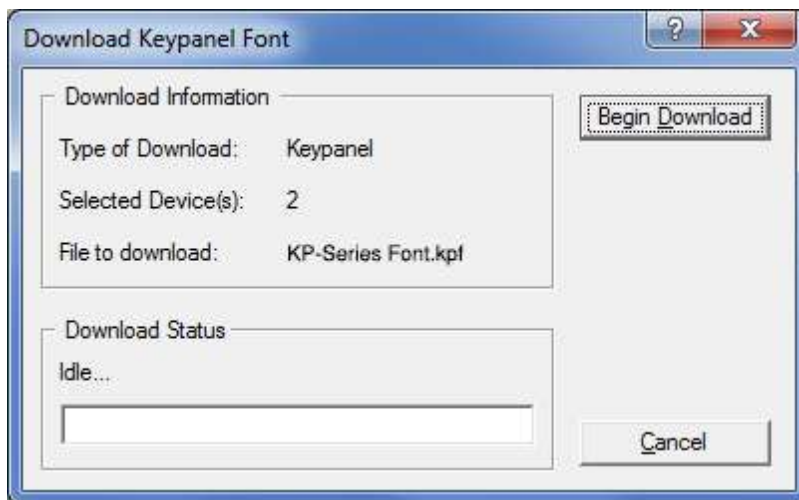

9. Click **Begin Download**.

The download begins. A progress bar appears to show the progress of the download.

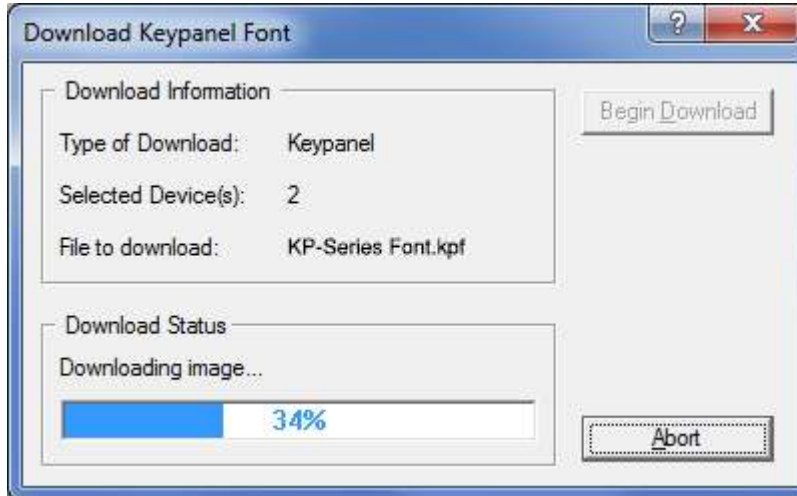

Once the download is complete the Download Keypanel Font window closes.

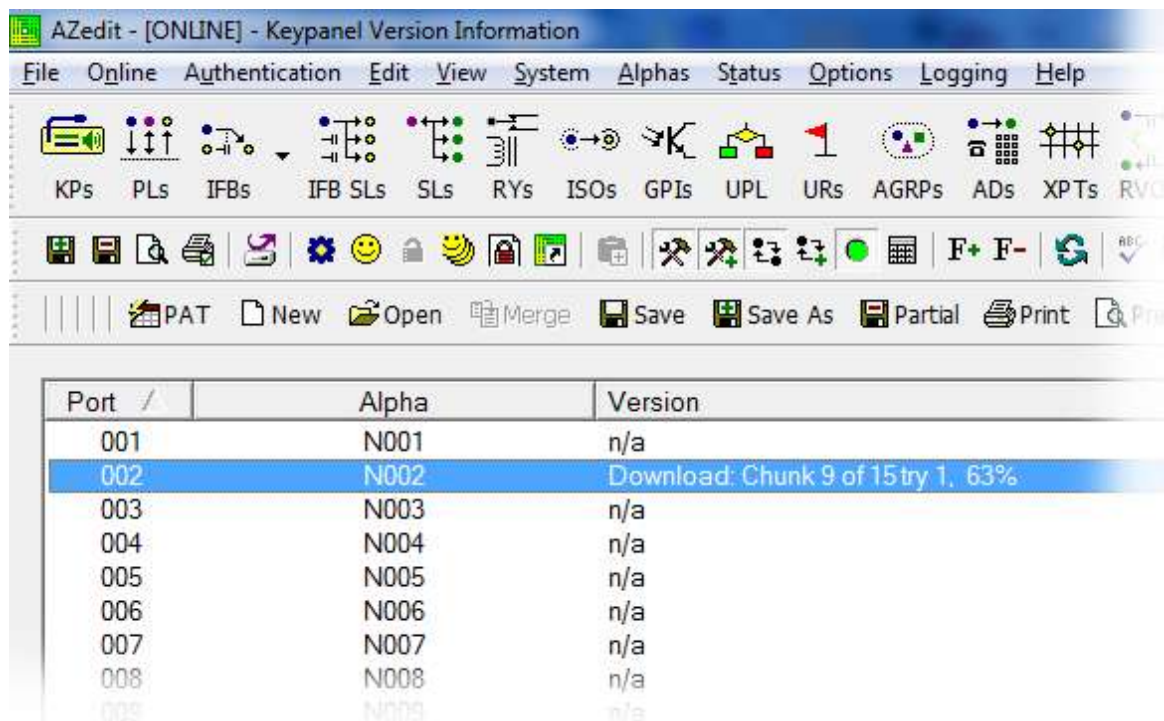
10. Verify the Keypanel Version Information window is displaying the **numbers of chunks (of data) transferred to the keypanel**.11. Verify the keypanel displays the **FONT Downloading icon with progression bar**.

Once the download is complete, the keypanel has to process the downloaded file.

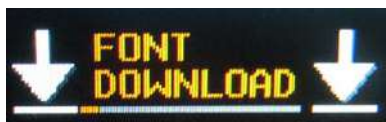

- Verify the Keypanel Version Information window displays **Processing download** on the keypanel port you chose.

Port /	Alpha	Version
118	N118	n/a
119	N119	n/a
120	N120	n/a
121	N121	n/a
122	N122	n/a
123	N123	n/a
124	N124	n/a
125	N125	n/a
126	N126	n/a
127	N127	n/a
128	N128	n/a
129	N129	n/a
130	N130	n/a
131	N131	Processing download
132	N132	n/a
133	N133	n/a
134	N134	n/a

- Verify the keypanel displays the **Processing Download icon with progression bar**.



- Once the keypanel is finished processing the download, the keypanel begins to **reprogram**.  
*The keypanel flashes a Reprogramming: Do Not Turn Off icon in the display panel. This can take several minutes.*



- Once the reprogramming is complete, the keypanel **reboots**.

---

### Download a Icon File

---

**IMPORTANT:** The following instructions can be used for either panel icons or tally (key overlays) icons.

---

- Open **AZedit**.
- From the Status menu, select **Software Versions|Keypanels**.  
*The Keypanel Version Information window appears.*
- Find and select the **Port** (keypanel) to be updated.  
*You may select more than one (1) at a time by holding CTRL key down while you select.*

- Right-click the **highlighted selection**.  
*A popup menu appears.*

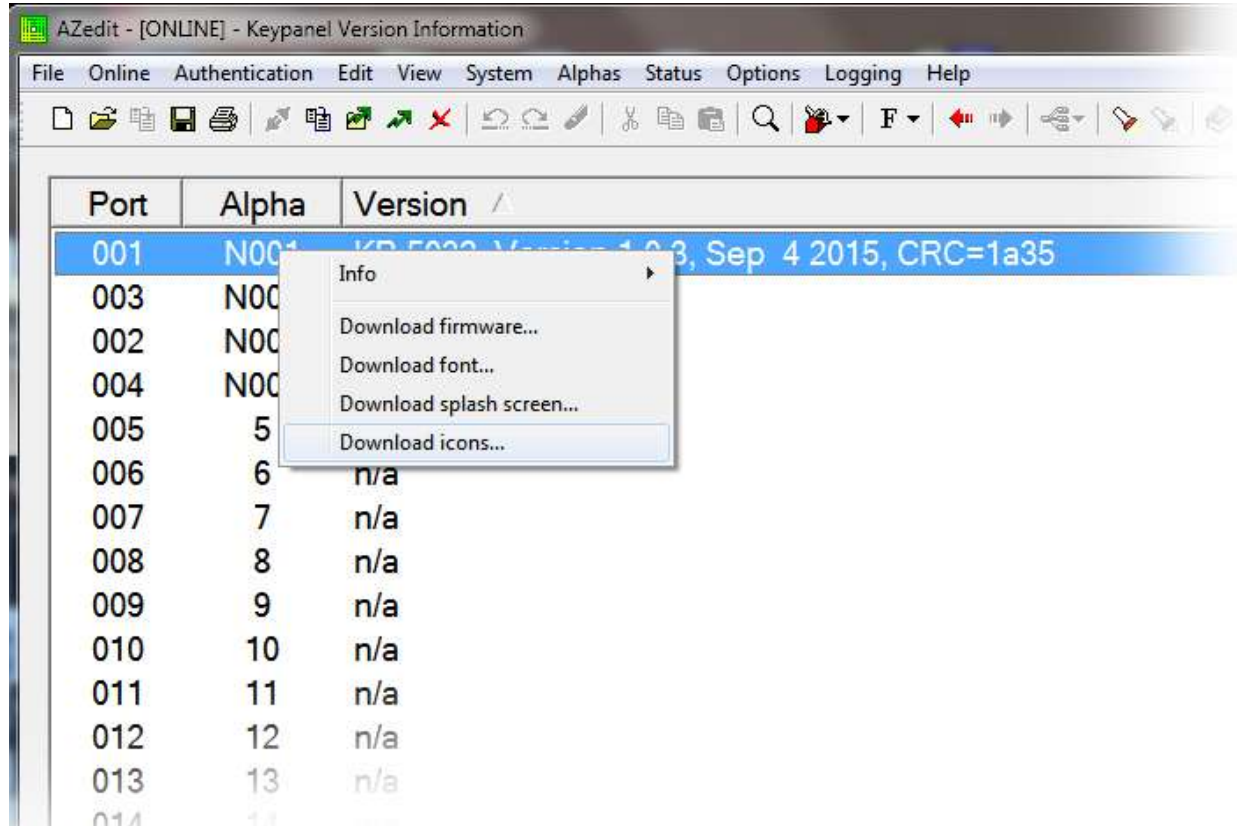

- Select **Download icons...**  
*The Icon Download window appears.*
- Navigate to the **icon file (.bmp or .jpg)** you want to use.
- Click **Open**.  
*The Download Keypanel Font window appears.*

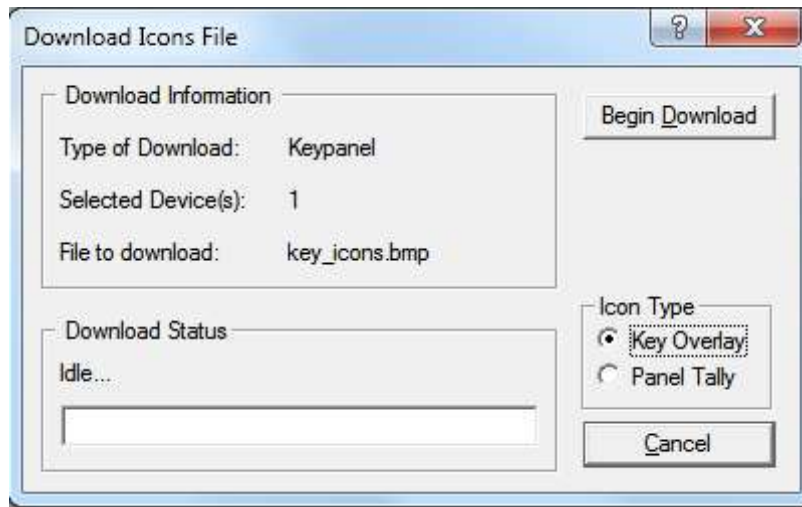

- Verify the correct **Icon Type radio button** is selected - Key Overlay or Panel Tally radio button.
- Click **Begin Download**.  
*The download begins. A progress bar appears to show the progress of the download. Once the download is complete the Download Keypanel Font window closes.*



- Verify the Keypanel Version Information window is displaying the **numbers of chunks (of data) transferred to the keypanel**.

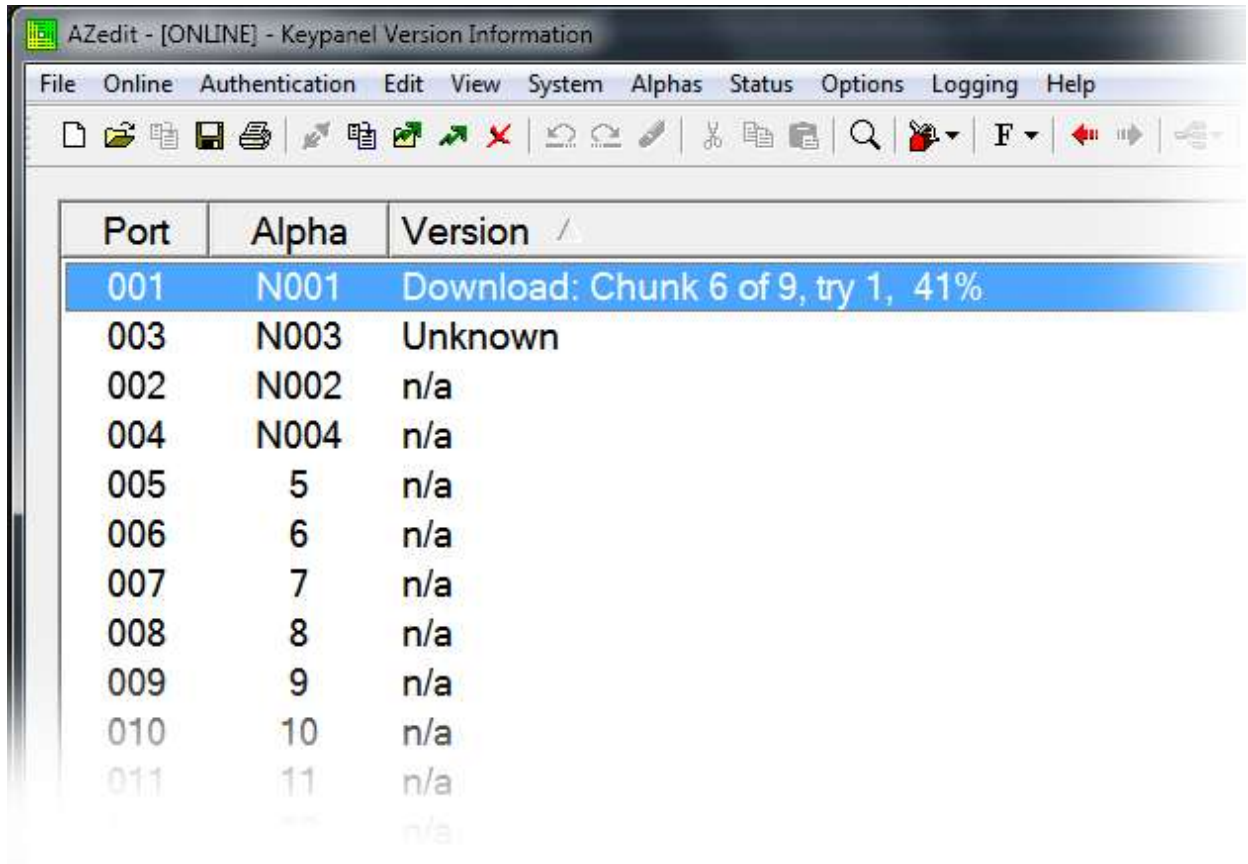

- Verify the keypanel displays the **ICON Downloading icon with progression bar**.

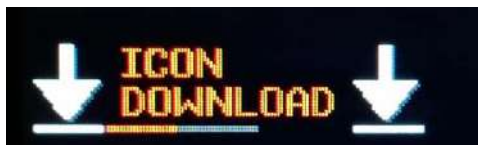

- Once the keypanel is finished downloading the icon file, the keypanel begins to **reprogram**.  
*The keypanel flashes a Reprogramming: Do Not Turn Off icon in the display panel. This can take several minutes.*



- Once the reprogramming is complete, the keypanel **reboots**.



## *KP-3016/3016A Menu System*

---

**NOTE:** A menu system quick reference chart is located at “Keypanel Menu Quick Reference” on page 141.

---

### *Main Menu Access*

---

**IMPORTANT:** For more detailed information on Basic Key operation, see “Menu Navigation and Shaft Encoder Knobs” on page 35.

---

The **Main Menu** is the top most level of the menu structure.

Available selections for this menu are:

*Audio Options*

*Display*

*Key Assign*

*Key Options*

*OMNEO Offers (Only available on KP-3016)*

*Save Config*

*Service*

To **access the main menu structure**, do the following:

1. On the keypad, press the **MENU button**.  
*The Main menu structure displays across the top of the panel display.*
2. Using the AUX Vol (MENU on the KP-3016A) encoder knob, navigate through the **menu options**.
3. Press the **SEL button**.  
OR  
Tap the **AUX Vol (MENU on the KP-3016A) encoder knob** to make a selection.  
*The submenu for the selection appears.*

---

## *Menu System, Audio Options*

Available options for this menu are:

*Advanced*  
*Chime*  
*Dim*  
*Headset Mic*  
*Headset Spkr*  
*Inputs*  
*Key Volumes*  
*Matrix Out*  
*Max Volume*  
*Mic Gain*  
*Mic Mute*  
*Min Volume*  
*Output Lev*  
*Panel Mic*  
*Sidetone*  
*Speaker*  
*Tone Gen*

## Audio Options Menu, Advanced

- AGC
- Compression
- Filters
- Gating
- Metering
- Mixing
- Mix Mode
- Noise Gate

### AGC

The **AGC** (Automatic Gain Control) menu is used to set the speed at which a microphone becomes active and the speed at which a sustainable level is achieved through the use of the Attack menu and the Decay menu. You can set these levels for the panel microphone and the headset microphones used with the keypanel.

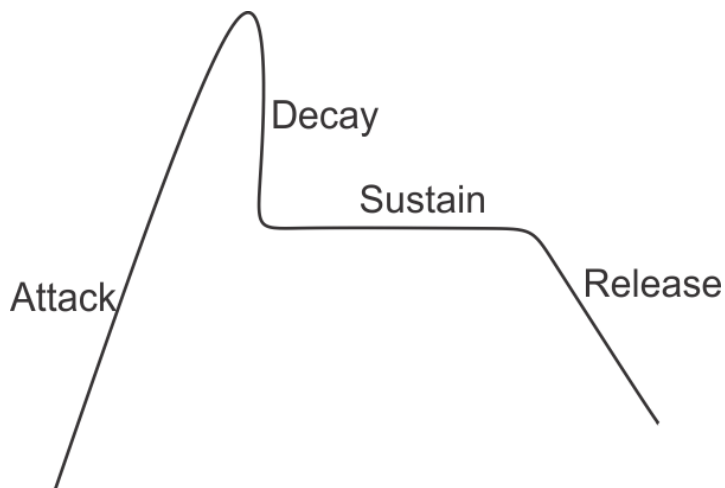

**FIGURE 22.** Automatic Gain Control Example

#### **Attack**

The **Attack** menu item is used to set the speed at which the microphone gets to the activation threshold, the point where the circuit determines if the noise is a voice. The smaller the attack time, the faster the mic turns on.

Available options for this menu are:

*0.5ms*

*1ms (d)*

*2ms*

#### **Decay**

The **Decay** menu item is used to set the speed at which the gain transitions to silence during release.

Available options for this menu are:

*500ms*

*750ms (d)*

*1000ms*

To **configure the attack speed for a microphone source**, do the following:

1. Starting at the Audio Options|Advanced|AGC menu, select **Attack**.
2. Press the **SEL button**.  
*Hdst Mic and Panel Mic appear in the panel display.*
3. Using the AUX/MENU shaft encoder, select **Hdst Mic** or **Panel Mic**.
4. Press the **SEL button**.  
*The Fast Attack Speed scroll box appears in the panel display.*
5. Using the AUX/MENU shaft encoder, select the **Attack speed** you desire.

To **configure the decay speed for a microphone source**, do the following:

1. Starting at the Audio Options|Advanced|AGC menu, select **Decay**.
2. Press the **SEL button**.  
*Hdst Mic and Panel Mic appear in the panel display.*
3. Using the AUX/MENU shaft encoder, select **Hdst Mic** or **Panel Mic**.
4. Press the **SEL button**.  
*The Decay scroll box appears in the panel display.*
5. Using the AUX/MENU shaft encoder, select the **Decay speed** you desire.

### **Compression**

The **Compression** menu item is used change the audio's gain, meaning audio above the threshold is changed according to the compression selected. The compression is used to reduce the output level.

Compression can be applied to the following:

- Headset
- Panel Mic

Available options are:

- 1:1*
- 2:1*
- 3:1(d)*

To **configure compression on a microphone**, do the following:

1. Starting at the Audio Options|Advance menu, select **Compression**.
2. Press the **SEL button**.  
*Hdst Mic and Panel Mic appear in the panel display.*
3. Using the AUX/MENU shaft encoder, select the **microphone source**.
4. Press the **SEL button**.  
*The Compression Ratio scroll box appears in the panel display.*
5. Using the AUX/MENU shaft encoder, select the **compression ratio** you want to apply to the microphone source.

## Filters

**Filters** allow you to add a bandpass filter, a preset frequency response (equalization) filter or a notch filter to one (1) or more audio sources.

### **Bandpass**

The **Bandpass** menu is used to enable using bandpass filters as well as set a low and high frequency range where frequencies within the two (2) frequency points are passed and anything outside of the range is rejected.

---

**IMPORTANT:** OMNEO outputs are not available for the KP-3016A.

---

To **configure a bandpass range for Inputs**, do the following:

1. Starting at the Audio Options|Advanced|Filters menu, select **Bandpass**.
2. Press the **SEL button**.  
*Outputs appears in the panel display.*
3. Using the AUX/MENU shaft encoder, select **Input**.
4. Press the **SEL button**.  
*OMNEO 1, and OMNEO 2 appear in the panel display.*

**NOTE:** OMNEO 1 is only available if it is not the matrix connection.

5. Using the AUX/MENU shaft encoder, select either **OMNEO 1** or **OMNEO 2**.
6. Press the **SEL button**.  
*Frequencies and Mode appear in the panel display.*
7. Using the AUX/MENU shaft encoder, select **Mode**.  
*Disabled and Enabled appear in the panel display.*
8. Using the AUX/MENU shaft encoder, select **Enabled**.
9. Press the **SEL button**.  
*An arrow appears next to the selected option.*
10. Press the **CLR button**.  
*Frequencies and Mode appear in the panel display.*
11. Using the AUX/MENU shaft encoder, select **Frequencies**.
12. Press the **SEL button**.  
*The Low Freq scroll box and the High Freq scroll box appear in the panel display.*
13. Using the AUX/MENU encoder knob, select the **low frequency** you desire.
14. Using the AUX/MENU shaft encoder, select the **high frequency scroll box**.
15. Using the AUX/MENU encoder knob, select the **high frequency** you desire.

To **configure a bandpass range for Outputs**, do the following:

1. Starting at the Audio Options|Advanced|Filters menu, select **Bandpass**.  
*Inputs and Outputs appears in the panel display.*
2. Using the AUX/MENU shaft encoder, select **Output**.
3. Press the **SEL button**.  
*Headset, Matrix Out, OMNEO 1, and OMNEO 2 appear in the panel display.*

**NOTE:** OMNEO 1 is only available if it is not the matrix connection. OMNEO is not available on the KP-3016A.

4. Using the AUX/MENU shaft encoder, select the **output** you desire to modify.

If Headset is chosen:

- a. Press the **SEL button**.  
*Both, Left Chan, and Right Chan appear in the panel display.*
- b. Using the AUX/MENU shaft encoder, select either **Both**, **Left Chan**, or **Right Chan**.
5. Press the **SEL button**.  
*Frequencies and Mode appear in the panel display.*
6. Using the AUX/MENU shaft encoder, select **Mode**.  
*Disabled and Enabled appear in the panel display.*
7. Using the AUX/MENU shaft encoder, select **Enabled**.
8. Press the **SEL button**.  
*An arrow appears next to the selected option.*
9. Press the **CLR button**.  
*Frequencies and Mode appear in the panel display.*
10. Using the AUX/MENU shaft encoder, select **Frequencies**.
11. Press the **SEL button**.  
*The Low Freq scroll box and the High Freq scroll box appear in the panel display.*
12. Using the AUX/MENU encoder knob, select the **low frequency** you desire.
13. Using the AUX/MENU shaft encoder, select the **high frequency scroll box**.
14. Using the AUX/MENU encoder knob, select the **high frequency** you desire.

### **Equalization**

**Equalization** allows the user to select predefined settings that modify the frequency envelope of an audio channel. This is a 5-band equalizer. Each preset provides a different EQ to be applied to the audio.

Available selections for this menu are:

<i>Default</i>	0 dB (15Hz–20kHz)
<i>Hiss Reduction</i>	0 dB (15Hz–2kHz) -6dB (2kHz–12.6kHz)
<i>Rumble Reduction</i>	0 dB (50Hz–20kHz)

To **configure a preset frequency response for an input**, do the following:

1. Starting at the Audio Options|Advanced|Filters menu, select **Equalization**.  
*Inputs and Outputs appears in the panel display.*
2. Using the AUX/MENU shaft encoder, select either **Input**.
3. Press the **SEL button**.  
*Hdst Mic, Matrix In, and Panel Mic appear in the panel display.*
4. Using the AUX/MENU shaft encoder, select either **Hdst Mic**, **Matrix In**, or **Panel Mic**.
5. Press the **SEL button**.  
*Mode and Presets appear in the panel display.*
6. Using the AUX/MENU shaft encoder, select **Mode**.  
*Disabled and Enabled appear in the panel display.*
7. Using the AUX/MENU shaft encoder, select **Enabled**.
8. Press the **SEL button**.  
*An arrow appears next to the selected option.*
9. Press the **CLR button**.  
*Mode and Presets appear in the panel display.*



10. Using the AUX/MENU shaft encoder, select **Presets**.
11. Press the **SEL button**.  
*Default, Hiss Reduction, and Rumble Reduction appear in the panel display.*
12. Using the AUX/MENU shaft encoder, select **Default, Hiss Reduction, or Rumble Reduction**.
13. Press the **SEL button**.  
*An arrow appears next to preset selected.*

To **configure a preset frequency response for an output**, do the following:

1. Starting at the Audio Options|Advanced|Filters menu, select **Equalization**.  
*Inputs and Outputs appears in the panel display.*
2. Using the AUX/MENU shaft encoder, select **Output**.
3. Press the **SEL button**.  
*Speaker appears in the panel display.*
4. Press the **SEL button**.  
*Mode and Presets appear in the panel display.*
5. Using the AUX/MENU shaft encoder, select **Mode**.  
*Disabled and Enabled appear in the panel display.*
6. Using the AUX/MENU shaft encoder, select **Enabled**.
7. Press the **SEL button**.  
*An arrow appears next to the selected option.*
8. Press the **CLR button**.  
*Mode and Presets appear in the panel display.*
9. Using the AUX/MENU shaft encoder, select **Presets**.
10. Press the **SEL button**.  
*Default, Hiss Reduction, and Rumble Reduction appear in the panel display.*
11. Using the AUX/MENU shaft encoder, select **Default, Hiss Reduction, or Rumble Reduction**.
12. Press the **SEL button**.  
*An arrow appears next to preset selected.*

### **Notch**

The **Notch** menu allows you to add a notch filter to matrix input. This can be useful when the keypad data port signal is being heard in the audio line due to cable routing problems.

By default, the notch filter is set to *Disabled*.

Available options for this menu are:

#### *Disabled*

*Narrow*                      9500hz–9700Hz (200Hz band)

*Default*                     9450hz–9750Hz (300Hz band)

*Wide*                        9400hz–9800Hz (400Hz band)

## Gating

**Gating** (also called VOX) allows you to minimize or eliminate background noise problems by shutting off an audio source when the audio level drops below a certain threshold.

Gating can be applied to the following:

*Hdst Mic*

*Matrix In*

*OMNEO 1 (only present if connected via the AIO, not available in the KP-3016A)*

*OMNEO 2 (not available in the KP-3016A)*

*Panel Mic*

The range for the gating threshold is *-17dB* to *+18dB*, and *Disabled*.

By default, the gating threshold is set to *Disabled*.

**NOTE:** 0dB threshold is 12dB below nominal. Nominal inputs are as follows:

*Headset Mics*                    *-50dBu*

*Matrix In*                        *8dBu*

*Panel Mics*                      *-42.5dBu*

*OMNEO 1-2*                      *8dBu*

To **configure gating on the keypad**, do the following:

1. Starting at the Audio Options|Advanced menu, select **Gating**.
2. Press the **SEL button**.  
*Hdst Mic, Matrix In, OMNEO 1, OMNEO 2, and Panel Mic appear in the panel display.*

**NOTE:** OMNEO 1 is only available if it is not the matrix connection. OMNEO is not available on the KP-3016A.

3. Using the AUX/MENU shaft encoder, select **Hdst Mic, Matrix In, OMNEO 1, OMNEO 2, or Panel Mic**.
4. Press the **SEL button**.  
*The Threshold scroll menu appears.*
5. Using the AUX/MENU shaft encoder, select the **threshold** you desire.
6. Press **CLR** to go to the previous menu item  
OR  
Press and hold **CLR** to exit the menu structure.

### *Metering*

**Metering** allows you to monitor an audio source connected to the keypanel. The energy of the incoming audio is split into five (5) bands and displayed on the left side of the keypanel when enabled.

The decibels display range is from 28dB below nominal to 8dB above nominal  
The bands are defined as:

<i>Band 1</i>	<i>100 Hz to 400 Hz</i>
<i>Band 2</i>	<i>400 Hz to 800 Hz</i>
<i>Band 3</i>	<i>800 Hz to 1.6 kHz</i>
<i>Band 4</i>	<i>1.6 kHz to 3.2 kHz</i>
<i>Band 5</i>	<i>3.2 kHz to 15 kHz</i>

**NOTE:** Only one (1) channel can be metered at a time.

You can enable metering on:

*Hdst Mic*

*Matrix In*

*None (d)*

*OMNEO 1 (only present if connected via the AIO, not available in the KP-3016A)*

*OMNEO 2 (not available in the KP-3016A)*

*Panel Mic*

To **enable metering**, do the following:

1. Starting at the Audio Options|Advanced menu, select **Metering**.
2. Press the **SEL button**.  
*Hdst Mic, Matrix In, None, OMNEO 1, OMNEO 2, and Panel Mic appear in the panel display.*

**NOTE:** OMNEO 1 is only available in AIO mode. OMNEO 1 and 2 are not available on the KP-3016A.

3. Using the AUX/MENU shaft encoder, select **Hdst Mic, Matrix In, None, OMNEO 1, OMNEO 2, or Panel Mic**.
4. Press the **SEL button**.  
*An arrow appears next to the selected option.*

**Mixing**

**Mixing** allows you to route selected audio signals to the following destinations:

- To Matrix
- Headset
- Speaker
- OMNEO 1 (only present if connected via the AIO, not available in the KP-3016A)
- OMNEO 2 (not available in the KP-3016A)

---

**IMPORTANT:** If OMNEO is enabled, OMNEO 1 is not available because it is acting as the To Matrix. On the other hand, if AIO is enabled, OMNEO 1 and OMNEO 2 are both available as auxiliary channels, except on the KP-3016A.

---

By default, the microphone signals are routed to the matrix. The matrix signal is routed to the speaker and to the left and right channels of the headphones. These defaults can be changed via the Audio Options sub-menus for Panel Mic, Headset Mic, Speaker, and Headset Speaker.

Available options for this menu are:

*Headset*

*OMNEO 1 (only present if connected via the AIO, not available in the KP-3016A)*

*OMNEO 2 (not available in the KP-3016A)*

*Speaker*

*To Matrix*

**TABLE 9.** Resources Table

<b>Destination</b>	<b>Source</b>	<b>Panel Mic</b>	<b>Matrix In</b>	<b>Hdst Mic</b>	<b>OMNEO 1</b>	<b>OMNEO 2</b>
<b>To Matrix</b>		a	X	a	X	X
<b>Headset</b>		X	b	X	X	X
<b>Speaker</b>		X	b	X	X	X
<b>Mic OUT</b>		a	X	a	X	X
<b>OMNEO Ch 1</b>		X	X	X	X	X
<b>OMNEO Ch 2</b>		X	X	X	X	X

- a. Mic inputs cannot be mixed to the Matrix using this menu. To mix mic inputs to the matrix output use the Panel Mic and Headset Mic menus
- b. The Matrix input cannot be mixed to speaker or headset outputs using the menu. To mix Matrix In to speakers or headset, use the Speaker and Headset Spkr menus.

To **configure mixing**, do the following:

1. Starting at the Audio Options|Advanced menu, select **Mixing**.
2. Press the **SEL button**.  
*Headset, OMNEO 1, OMNEO 2, Speaker, and To Matrix appear in the panel display.*

**NOTE:** OMNEO 1 is only available in AIO mode. OMNEO 1 and 2 are not available on the KP-3016A.

3. Using the AUX/MENU shaft encoder, select a the **destination** to mix to (or the destination to which the sources are mixed).

**NOTE:** If Headset is chosen, an additional step of choosing Both, Left Chan, or Right Chan is required.

4. Press the **SEL button**.  
*A list of available inputs appear in the panel display.*
5. Using the AUX/MENU shaft encoder, select the **input** to mix to the selected output.
6. Press the **SEL button**.  
*An arrow appears next to the selection.*

**NOTE:** Repeat steps 5 and 6 to select additional inputs to mix to the selected output.

### **Mix Mode**

The **Mix Mode** menu is used to control whether mixes made to the speakers and headsets are muted when they are not active.

Available options for this menu are:

- |  |  |
|--|--|
| <i>Mixes to Spkr/Hdst Switched (d)</i> | Aux inputs mixed to speakers or headsets are only heard when the panel is in the appropriate headset or speaker mode.    |
| <i>Mixes always active</i>             | Aux inputs mixed to speakers or headset are always heard, regardless of whether the panel is in headset or speaker mode. |

To **configure Mix Mode**, do the following:

1. Starting at the Audio Options|Advanced menu, select **Mix Mode**.
2. Press the **SEL button**.  
*Mixes to Spkr/Hdst Switched and Mixes Always Active appear in the panel display.*
3. Using the AUX/MENU shaft encoder, select the **mix mode** you desire.
4. Press the **SEL button**.  
*An arrow appears next to the selection.*

### **Noise Gate**

The **Noise Gate** menu is used to enable or disable the audio level (-72dBu) at which the mic turns on. When noise gate is enabled, microphone noise gate is set to -72dBu; when the noise gate is disabled, the microphone is always on.

To **enable/disable noise gate**, do the following:

1. Stating at the Audio Options|Advanced menu, select **Noise Gate**.
2. Press the **SEL button**.  
*Hdst Mic and Panel Mic appear in the panel display.*
3. Using the AUX/MENU encoder knob, select the **Hdst Mic** or **Panel Mic**.
4. Press the **SEL button**.  
*Disable and Enable appear in the panel display.*
5. Using the AUX/MENU encoder knob, select **Disable** or **Enable**.

## Audio Options Menu, Chime

The **Chime** menu is used to set the volume for each of the built-in chimes, as well as to enable or disable preview of chimes during chime selection in this menu and others that reference chimes.

Available configurable options for this menu are:

<i>Preview</i>	When enabled, a preview of the chime is played each time a new chime is selected or while the volume is being adjusted, so you can listen to what it sounds like.
<i>Chime</i>	Allows the user to select between 12 system chimes.
<i>Volume</i>	Controls the volume of the chime. This field ranges from <i>-60dB to 10dB</i> . The default for this field is <i>-20dB</i> .

To **configure Chime Volumes on the keypad**, do the following:

1. Starting at the Audio Options menu, select **Chime**.
2. Press the **SEL button**.  
*The Preview, Chime, and Volume scroll boxes appear in the panel display.*
3. Using the AUX/MENU encoder knob, select **Yes** or **No** for Preview.
4. Using the AUX/MENU shaft encoder, select **Chime**.
5. Using the AUX/MENU encoder knob, select the **desired chime**.
6. Using the AUX/MENU shaft encoder, select **Volume**.
7. Using the AUX/MENU encoder knob, select the **volume** you want the chime to sound.

## Audio Options Menu, Dim

To **configure Dim on the keypad**, do the following:

1. Starting at Audio Options, select **Dim**.
2. Press the **SEL button**.  
*Headset and Speaker appear in the panel display.*
3. Using the AUX/MENU shaft encoder, select **Headset** or **Speaker**.
4. Press the **SEL button**.  
*The Dim Amount scroll box appears.*
5. Using the AUX/MENU shaft encoder, select the **Dim Amount** you desire.

## Audio Options Menu, Headset Mic

The **Headset Mic** option allows the user to configure where audio is coming from and the type of microphone being used.

By default, if no headset is detected, the headset mic input is muted to avoid allowing noise to get to the system. This feature can be disabled.

### *Auto-Mute*

The **Auto-Mute** option is used to automatically mute the Mic Input when a headset mic is not detected.

Available selections for the Auto-mute menu are:

*Disabled*

*Enabled*

### *Mode*

Available selections for the Mode menu are:

*Disabled*

*Enabled*

*Switched*

When set to Switched, the state of the Headset Mic is controlled by the Mic Sel key.

### *Type*

Available selections for the Type menu are:

*Auto-Detect (d)*

The keypanel automatically detects the type of microphone connected.

*Dynamic*

*Electret*

To **configure the Headset Mic Auto-mute**, do the following:

1. Starting at the Audio Options menu, select **Headset Mic**.
2. Press the **SEL button**.  
*Auto-Mute, Mode and Type appear in the panel display.*
3. Using the AUX/MENU shaft encoder, select **Auto-Mute**.
4. Press the **SEL button**.  
*Disabled and Enabled appear in the panel display.*
5. Using the buttons, select **Disabled** or **Enabled**.
6. Press the **SEL button**.  
*An arrow appears next to the selected option.*

To **configure the Headset Mic Mode**, do the following:

1. Starting at the Audio Options menu, select **Headset Mic**.
2. Press the **SEL button**.  
*Auto-Mute, Mode and Type appear in the panel display.*
3. Using the AUX/MENU shaft encoder, select **Mode**.
4. Press the **SEL button**.  
*Disabled, Enabled, and Switched appear in the panel display.*
5. Using the AUX/MENU shaft encoder, select **Disabled, Enabled, or Switched**.
6. Press the **SEL button**.  
*An arrow appears next to the selected option.*

To **configure the Headset Mic Type**, do the following:

1. Starting at the Audio Options menu, select **Headset Mic**.
2. Press the **SEL button**.  
*Auto-Mute, Mode and Type appear in the panel display.*
3. Using the AUX/MENU shaft encoder, select **Type**.
4. Press the **SEL button**.  
*Auto-Detect, Dynamic, and Electret appear in the panel display.*
5. Using the AUX/MENU shaft encoder, select **Auto-Detect, Dynamic, or Electret**.
6. Press the **SEL button**.  
*An arrow appears next to the selected option.*

### Audio Options Menu, Headset Speaker

The **Headset Spkr** menu option is used to control the headset detection functions: auto-transfer, which is used to detect if a headset is present and mode, which determines when and where audio is heard.

#### *Auto-Transfer*

Available selections for the Auto-transfer menu are:

*Disabled*

*Enabled*                      When enabled, the keypanel automatically enters or leaves headset mode when a headset is plugged in or removed.

To **configure the Headset Auto-Transfer function**, do the following:

1. Starting at the Audio Options|Headset Spkr menu, select **Auto-Transfer**.
2. Press the **SEL button**.  
*Disabled and Enabled appear in the panel display.*
3. Using the AUX/MENU shaft encoder, select **Disabled or Enabled**.
4. Press the **SEL button**.  
*An arrow appears next to the selected option.*



## Mode

Available selections for the Mode menu are:

*Always On (d)*

*Disabled*

*Switched*

When set to Switched, the state of the Headset is controlled by the Mic Sel key.

To **configure the Headset Spkr Mode**, do the following:

1. Starting at the Audio Options|Headset Spkr menu, select **Mode**.
2. Press the **SEL button**.  
*Both, Left Chan, and Right Chan appear in the panel display.*
3. Using the AUX/MENU shaft encoder, select the **mode** you want.
4. Press the **SEL button**.  
*Always On, Disabled, and Switched appear in the panel display.*
5. Using the AUX/MENU shaft encoder, select the **mode**.
6. Press the **SEL button**.  
*An arrow appears next to the selected option.*

## Audio Options Menu, Inputs

The **Inputs** menu is used to enable or disable volume control for audio inputs through the front panel shaft encoder. By default, all inputs are enabled. This means the inputs are visible as inputs in the Mixing menu and (if mixed somewhere) can be selected for volume control.

If disabled, the inputs are not visible in the mixing menu and cannot be selected for volume control.

**NOTE:** Disabling an input does not undo any of the mixes you had previously established in the Mixing menu; however, it hides access to volume control of this input. This is useful if you want to set the matrix input volume, and then want to disable the volume control so users cannot adjust the Matrix volume.

To **enable or disable an input**, do the following:

1. Starting at the Audio Options|Inputs menu, select **Matrix In, OMNEO1** or **OMNEO2**.

**NOTE:** OMNEO 1 is only available in AIO mode. OMNEO 1 and 2 are not available on the KP-3016A.

2. Press the **SEL button**.  
*Disabled and Enabled appear in the panel display.*
3. Using the AUX/MENU shaft encoder, select **Enabled** to enable the selected Input.  
OR  
Using the AUX/MENU shaft encoder, select **Disabled** to disable the selected Input

## Audio Options Menu, Key Volumes

The **Key Volumes** menu is used to enable or disable the adjusting of crosspoint listen gains. If key volumes are enabled, the user can adjust the list gains for Matrix crosspoints from the keypanels. Alternatively, you can reset key gains back to their default settings.

Available options for this menu are: *Adjust*, *Minimum*, and *Reset*.

### **Minimum**

The **Minimum** menu item is used to allow an administrator to set a minimum crosspoint volume for individual keys. This prevents users from lowering the crosspoint volume to an inaudible or muted level.

Available options for the minimum volume levels are: *-80dB to +6dB*, and *Mute*.

**NOTE:** Key Volumes are either enabled for the entire keypanel or disabled for the entire keypanel. This setting cannot be set on a per key basis.

To **enable key volumes**, do the following:

1. Starting at the Audio Options|Key Volumes menu, select **Adjust**.
2. Press the **SEL button**.  
*Disabled and Enabled appear in the panel display.*
3. Using the AUX/MENU shaft encoder, select **Enabled**.
4. Press the **SEL button**.  
*Key volume adjustments are allowed by users.*

To **set the minimum volume on every key**, do the following:

1. Starting at the Audio Options|Key Volumes menu, select **Minimum**.
2. Press the **SEL button**.  
*Adjust Minimum Key Volumes appears in the panel display and the individual keys become active to change the minimum volume.*
3. Using the lever associated with the keypanel key, press **the lever key up** and turn the **AUX Vol. encoder knob to the left or right** to decrease or increase the volume.

**NOTE:** A listen assignment must be present to be able to adjust the key volume.

To **reset all key gains to their default value**, do the following:

1. Starting at the Audio Options|Key Volumes menu, select **Reset**.
2. Press the **SEL button**.  
*Cancel and Do Reset appear in the panel display.*
3. Using the AUX/MENU shaft encoder, select **Do Reset**.
4. Press the **SEL button**.  
*Volumes reset appears in the panel display.*

### Audio Options Menu, Matrix Out

**Matrix Out** allows the user to select between Normal or Hot Mic. In Normal setting, audio from the selected active mic (based on the mic select feature, see “Audio Options Menu, Panel Mic” on page 103) goes out to the Matrix when any talk key is active. In the Hot Mic setting, audio from the mic goes out to the Matrix without regard to the talk key state.

By default, Matrix Out is set to *Normal* operation.

To **configure Matrix Out**, do the following:

1. Starting at the Audio Options|Matrix Out menu, select **Hot Mic** or **Normal**.
2. Press the **SEL button**.  
*An arrow appears next to the selected option.*

**NOTE:** When Hot Mic is enabled, the Hot Mic icon appears in the panel display.

### Audio Options Menu, Max Volume

The **Max Volume** menu is used to set the maximum level, in dB, of the volume the user can configure for a headset or a speaker. This feature prevents incoming audio from being too loud.

The range for this field is *-48dB* to *10dB*, and *Mute*.

The default setting is *10dB*.

To **set the maximum volume for headsets or speakers**, do the following:

1. Starting at the Audio Options|Max Volume menu, select **Headset** or **Speaker**.
2. Press the **SEL button**.  
*The Max Volume: scroll box appears in the panel display.*
3. Using the AUX/MENU shaft encoder, scroll to the **maximum volume** you desire.

### Audio Options Menu, Mic Gain

**Mic Gain** allows the user to adjust the mic gain level. For more information, see “Keypanel Volume Adjustments” on page 38, “Keypanel Volume Adjustments” on page 38, and “Aux Volume Adjustments (KP-3016 Only)” on page 39.

The range for this field is *-20dB* to *10dB*.

By default, this field is set to *0dB*.

To **set the Mic Gain level**, do the following:

1. Starting at the Audio Options|Mic Gain menu, select **Hdst Mic** or **Panel Mic**.
2. Press the **SEL button**.  
*The Mic Gain scroll box appears in the panel display.*
3. Using the AUX/MENU shaft encoder, scroll to the **mic gain level** you desire.

## Audio Options Menu, Mic Mute

The **Mic Mute** menu is used to configure the actions of the Mic Mute key.

Available options are:

- Disabled* – By disabling the mic mute key, users are not able to mute the microphone from the front panel.
- Momentary* – The mic is muted for only as long as the mic mute key is held on.
- Toggle* – The mic mute key is enabled. In this mode, pressing the mic mute key toggles the mic mute state on and off.

By default, the Mic Mute menu is set to *toggle*.

To **disable Mic Mute**, do the following:

1. Starting at the Audio Options menu, select **Mic Mute**.
2. Press the **SEL button**.  
*Disable, Momentary and Toggle appear in the panel display.*
3. Using the AUX/MENU shaft encoder, select **Disabled, Momentary, or Toggle**.
4. Press the **SEL button**.  
*An arrow appears next to the selected option.*

## Audio Options Menu, Min Volume

The **Min Volume** menu item is used to set the minimum volume level, in dB, for different inputs and outputs on the keypad. This is the minimum volume level available when using the Main Volume and Aux Volume control knob, located on the front of the keypad.

Available sources are: *Headset, Speaker, Matrix In, OMNEO 1, and OMNEO 2*.

**NOTE:** OMNEO 1 is only available in AIO mode. OMNEO 1 and 2 are not available on the KP-3016A.

The range for this field is *-48dB to 10dB*, and *Mute*.

By default, this field is set to *Mute*.

To **set the min volume**, do the following,

1. Starting at the Audio Options|Min Volume menu, select the **source** to set the minimum volume on.
2. Press the **SEL button**.  
*The Min Volume: scroll box appears in the panel display.*
3. Using the AUX/MENU shaft encoder, scroll to the **minimum volume** you desire.

## Audio Options Menu, Output Level

The **Output Level** menu is used to adjust the nominal audio output level to the matrix.

The range for this field is *0dB to 8dB*.

By default, the output level is set to *8dB*.

## Audio Options Menu, Panel Mic

The **Panel Mic** menu option is used to configure how the panel mic operates.

Available options for this field are:

*Disabled*

*Enabled*

*Switched*

When enabled, the state of the Panel Mic is controlled by the Mic Sel key.

By default Panel Mic is configured to *switched*.

To **configure the panel mic**, do the following:

1. Starting at the Audio Options, select Panel Mic.
2. Press the **SEL button**.  
*Disabled, Enabled, and Switched appear in the panel display.*
3. Using the AUX/MENU shaft encoder, select the **mode**.
4. Press the **SEL button**.  
*An arrow appears next to the selected option.*

## Audio Options Menu, Sidetone

The **Sidetone** menu is used to configure the level, in dB, at which the user hears their own voice. Most people prefer some amount of sidetone to overcome the muffled sensation when talking, especially when wearing a dual-sided headset. You can also configure the mode sidetone operates.

The range for this field is *-65dB to 0dB*.

By default, the sidetone level is set at *-20dB*.

The available options for the sidetone mode are:

*Always On*

*Disabled*

*Switched (d)*

When set to Switched, the user's voice is heard only when a talk key is activated.

To **set the sidetone level**, do the following:

1. Starting at the Audio Options|Sidetone menu, select **Level**.
2. Press the **SEL button**.  
*The Sidetone Level scroll menu appears in the panel display. By default, sidetone is set to -20dB.*
3. Using the AUX/MENU shaft encoder, adjust the **sidetone level**.

To **set the sidetone mode**, do the following:

1. Starting at the Audio Options|Sidetone menu, select **Mode**.
2. Press the **SEL button**.  
*Always On, Disabled, and Switched appear in the panel display.*
3. Using the AUX/MENU shaft encoder, select the **mode** to operate sidetone.
4. Press the **SEL button**.

## Audio Options Menu, Speaker

The **Speaker** menu option is used to configure how the speaker operates.

Available selections are:

*Always On*

*Disabled*

*Switched*                      When set to Switched, the state of the speaker is controlled by the Mic Sel key.

To **configure the speaker**, do the following:

1. Starting at the Audio Options menu, select **Speaker**.
2. Press the **SEL button**.  
*Always On, Disabled and Switched appear in the panel display.*
3. Using the AUX/MENU shaft encoder, select the **option** you want configured.
4. Press the **SEL button**.  
*An arrow appears next to the selected option.*

## Audio Options Menu, Tone Gen

**Tone Gen** (tone generation) allows the user to turn the tone generator on or off. The tone generator is used to check the audio path from the keypanel to the matrix.

Available selections for this menu are:

*500Hz Tone (d)*

*1kHz Tone*

To **enable/disable the tone generator**, do the following:

- > Starting at the Audio Options|Tone Gen menu, select **Tone Off** to disable the tone generator.  
OR  
Using the AUX/MENU shaft encoder, select **Tone On** to enable the tone generator.  
*An arrow appears next to the selected option.*

To **set the frequency level for the tone**, do the following:

1. Starting at the Audio Options|Tone Gen menu, select **Frequency**.
2. Press the **SEL button**.  
*1kHz Tone and 500Hz Tone appears in the panel display.*
3. Using the AUX/MENU shaft encoder, select **1kHz Tone** or **500Hz Tone**.  
*An arrow appears next to the selected option. If tone is enabled, an icon indicating 500Hz or 1kHz displays once the menu is exited.*

---

## *Menu System, Display*

Use this menu to display information about the keypanel configuration.

The information available for display is as follows:

*Assign Type*  
*Chans On*  
*Chime*  
*Exclusive*  
*Key Groups*  
*Key List*  
*Level 2 (Key Assignments)*  
*Listen (Assignments)*  
*Matrix*  
*Panel ID*  
*Solo Key*  
*(Keypanel Firmware) Version*

### **Display Menu, Assign Type**

**Assign Type** displays the talk level 1 assignment types for all keys.

To **display the types of key assignments assigned to the KP-3016/3016A**, do the following:

1. On the keypanel, press **MENU**.  
*The Information menu appears.*
2. Using the AUX/MENU shaft encoder, select **Display**.
3. Press the **SEL button**.  
*The Display submenu appears.*
4. Using the AUX/MENU shaft encoder, select **Assign Type**.
5. Press the **SEL button**.  
*The assignment types appear on the appropriate key displays.*

### **Display Menu, Chans On**

**Chans On** displays a scroll list of all intercom ports with crosspoints currently closed to this keypanel. Chans On is typically used to locate an open mic or other open audio source that needs to be shut off. The most likely cause is a talk key that has been left on at some keypanel. In this case, use the arrow buttons to quickly page-scroll through the list of names. Press the call waiting window key to ask the person at the other end of the connection to turn off the talk key.

To **display the Chans On information**, do the following:

1. Starting at the Display menu, select **Chans On**.
2. Press the **SEL button**.  
*The Chans On display appears showing the active channels.*

## Display Menu, Chime

**Chime** displays all keys with the chime option enabled on them in red. For more information, see “Key Options Menu, Chime” on page 114.

To **display keys with Chime enabled**, do the following:

1. Starting at the Display menu, select **Chime**.
2. Press the **SEL button**.  
*The Chime display appears showing chime enabled keys in red.*

## Display Menu, Exclusive

**Exclusive** displays all keys with the exclusive key assignment. For more information, see “Key Options Menu, Exclusive” on page 115.

To **display the Exclusive Keys information**, do the following:

1. Starting at the Display menu, select **Exclusive**.
2. Press the **SEL button**.  
*The Exclusive display appears showing exclusive keys in red.*

**NOTE:** You can assign more than one (1) Exclusive key. Only one (1) key marked as an Exclusive key can be turned on at any time. Pressing an Exclusive key turns off any other Exclusive key already active.

## Display Menu, Key Groups

**Key Groups** displays a scroll list of groups available on the keypad.

To **display the different groups available**, do the following:

1. Starting at the Display menu, select **Key Groups**.
2. Press the **SEL button**.  
*Group 1, Group 2, Group 3, and Group 4 appear in the panel display.*
3. Using the AUX/MENU shaft encoder, select the **Group** you want to display.
4. Press the **SEL button**.  
*The Master key appears in red, while the slave keys appear in green.*



## Display Menu, Key List

**Key List** displays and allows users to see all the other assignments on other keypanel pages not currently showing in the keypanel display.

To **display the Key List information**, do the following:

1. Starting at the Display menu, select **Key List**.
2. Press the **SEL button**.  
*The Key List displays all the assignments not currently displayed on the keypanel.*

## Display Menu, Level 2

**Level 2** displays the talk level 2 assignments for any key that has them assigned. Talk level 2 assignments are used to call two (2) users at one (1) time, activated when the Level 1 assignment is used.

To **display the Listen information**, do the following:

1. Starting at the Display menu, select **Level 2**.
2. Press the **SEL button**.  
*The Level 2 display appears showing the level 2 talk assignments.*

## Display Menu, Listen

**Listen** displays the listen assignments for all keys, if applicable.

To **display the Level 2 Talk information**, do the following:

1. Starting at the Display menu, select **Listen**.
2. Press the **SEL button**.  
*The Listen display appears showing the listen assignments for all keys (if assigned).*

## Display Menu, Matrix

**Matrix** displays the intercom system name for all talk level 1 key assignments. The local intercom is represented by a green key, while a remote intercom is represented by a red key. If a key assignment is not present on a key, an unassigned key displays.

In non-trunked intercom systems, the intercom system name is always LOCL (local). In trunked systems, intercom system names are created in TrunkEdit (*Intercoms/Names*).

To **display the matrix intercom system name**, do the following:

1. Starting at the Display menu, select **Matrix**.
2. Press the **SEL button**.  
*The Matrix display appears showing the matrix intercom system.*

## Display Menu, Panel ID

**Panel ID** displays the port number to which the keypanel is connected.

**NOTE:** When the keypanel is not scroll enabled, the Panel ID displays only the port number in the panel display. When the keypanel is scroll enabled, the port number and port alpha are displayed.

To **display the panel ID**, do the following:

1. Starting at the Display menu, select **Panel ID**.
2. Press the **SEL button**.  
*The Panel ID display appears showing the port number and alpha (if applicable) for the keypanel.*

## Display Menu, Solo

**Solo** displays the key with the solo assignment. For more information, see “Key Options Menu, Latching” on page 117.

To **display the Solo Key information**, do the following:

1. Starting at the Display menu, select **Solo**.
2. Press the **SEL button**.  
*The Solo display appears showing solo keys in red.*

**NOTE:** You may only assign one (1) solo key at a time.

## Display Menu, Version

**Version** displays the firmware version currently running on the keypanel.

**NOTE:** For firmware upgrades, contact customer service. The keypanel firmware can be upgraded through AZedit.

To **display the firmware version currently loaded on the keypanel**, do the following:

1. Starting at the Display menu, select **Version**.
2. Press the **SEL button**.  
*The Version display appears showing firmware version for the keypanel.*

---

## *Menu System, Key Assign Menu*

The **Key Assign** menu is used to assign intercom key assignments and auto functions to keypad keys.

Available options for this menu are:

*Matrix (only in trunked systems)*

*Pt-to-Pt*

*Party Line*

*IFB*

*Special List*

*Sys Relay*

*Camera ISO*

*UPL*

*IFSL*

*Auto Func*

To **access the key assign menu options**, do the following:

1. Starting at the Key Assign menu, select the **key assignment type** you want to assign.
2. Press the **SEL button**.  
*A scroll list of available assignments appears.*

### **Key Assign Menu, Matrix (Trunked System Only)**

**Matrix** only appears for trunked intercom systems. You must select a remote intercom matrix before assigning intercom keys to destinations in that matrix. You do not need to select matrix to assign keys to destinations in your own matrix. Also, you do not need to select matrix when assigning an auto function key to a matrix.

To **assign a remote assignment to the KP-3016/3016A**, do the following:

1. Starting at the KeyAssign|Matrix menu, select a **remote intercom**.
2. Press the **SEL button**.  
*A scroll list of available assignments appears.*
3. Using the AUX/MENU shaft encoder, select the **assignment** you want to assign to the keypad key.
4. Press the **SEL button**.  
*A list of auto-functions appear.*
5. Using the AUX/MENU shaft encoder, select the **auto-function** you want to assign to the assignment, if applicable.
6. Press the **SEL button**.  
*Tap Key appears in the panel display.*
7. Press down on the **keypanel key position** where you want the assignment to appear.  
*The alpha name appears on the key.*

## Key Assign Menu, Pt-to-Pt

**Pt-to-Pt** assigns a key that talks or listens to another intercom port.

**NOTE:** Some Pt-to-Pt destinations may be non-keypanel devices that cannot activate talk and listen paths. Therefore, if you want full communication, you may need to assign both talk and listen on the key. For more information, see “Key Assign Menu, Auto Func” on page 113.

To **assign Pt-to-Pt to the keypanel key**, do the following:

1. Starting at the Key Assign|Pt-to-Pt menu, select the **port** you want to assign to the keypanel key.
2. Press the **SEL button**.  
*A list of auto-functions appear.*
3. Using the AUX/MENU shaft encoder, select the **auto-function** you want to assign to the Pt-to-Pt assignment, if applicable.
4. Press the **SEL button**.  
*Tap Key appears in the panel display.*
5. Press down on the **keypanel key position** where you want the Pt-to-Pt assignment to appear.  
*The key color changes and the alpha appears on the key.*

## Key Assign Menu, Party Line

**Party Line** assigns a key that talks and/or listens to a party line. Party Lines are defined in AZedit.

**NOTE:** Party Line members are usually non-keypanel devices that cannot activate talk and listen paths. Therefore, if you want full communication, you need to assign both talk and listen on the key. If all communications are normally 2-way, you may wish to assign the key as Talk+Auto Listen.

To **assign a Party Line to the keypanel key**, do the following:

1. Starting at the KeyAssign|Party Line menu, select the **party line** you want to assign to the keypanel key.
2. Press the **SEL button**.  
*A list of auto-functions appear.*
3. Using the AUX/MENU shaft encoder, select the **auto-function** you want to assign to the Party Line assignment, if applicable.
4. Press the **SEL button**.  
*Tap Key appears in the panel display.*
5. Press down on the **keypanel key position** where you want the Party Line assignment to appear.  
*The key color changes and the alpha appears on the key.*

## Key Assign Menu, IFB

**IFB** assigns the IFB assignment type to a key. By default, all IFBs are restricted. You must select the appropriate scroll enable check box in AZedit, to see IFBs.

To **assign an IFB to the keypanel key**, do the following:

1. Starting at the KeyAssign|IFB menu, select the **IFB assignment** you want to assign to the keypanel key.
2. Press the **SEL button**.  
*A list of auto-functions appear.*
3. Using the AUX/MENU shaft encoder, select the **auto-function** you want to assign to the IFB assignment, if applicable.
4. Press the **SEL button**.  
*Tap Key appears in the panel display.*
5. Press down on the **keypanel key position** where you want the IFB assignment to appear.  
*The key color changes and the alpha appears on the key.*

## Key Assign Menu, Spcl List

**Spcl List** assigns a key that talks and/or listens to a special list. The key is not available until members have been assigned to the special list in AZedit.

**NOTE:** Special List members can be non-keypanel devices that cannot activate talk and listen paths. Therefore, if you want full communication with all members of the special list, you may need to assign both talk and listen on the key.

To **assign a Special List to the keypanel key**, do the following:

1. Starting at the KeyAssign|Special List menu, select the **Special List** you want to assign to the keypanel key.
2. Press the **SEL button**.  
*A list of auto-functions appear.*
3. Using the AUX/MENU shaft encoder, select the **auto-function** you want to assign to the Special List assignment, if applicable.
4. Press the **SEL button**.  
*Tap Key appears in the panel display.*
5. Press **down** on the keypanel key position where you want the Special List assignment to appear.  
*The key color changes and the alpha appears on the key.*

## Key Assign Menu, Sys Relay

**Sys Relay** refers to any of several types of control devices that can exist in the intercom system, including:

- The 8 GPI outputs from an ADAM Frame (J11 on the XCP-ADAM-MC Breakout Panel).
- The 8 GPI outputs from an ADAM CS Frame (J903 on the ADAM CS back panel).
- The relay outputs of an FR9528 Relay Frame (RELAY OUTPUTS connector on the FR9528 back panel).
- The 16 GPI outputs of a UIO-256 or GPIO-16 Frame (J5 on the UIO-256/GPIO-16 back panel).

To **assign a Relay to the keypanel key**, do the following:

1. Starting at the KeyAssign|Sys Relay menu, select the **relay** you want to assign to the keypanel key.
2. Press the **SEL button**.  
*A list of auto-functions appear.*

**NOTE:** You will not hear anything if you listen to a Relay, but you can activate the relay with either a talk or listen key.

3. Using the AUX/MENU shaft encoder, select the **auto-function** you want to assign to the relay assignment, if applicable.
4. Press the **SEL button**.  
*Tap Key appears in the panel display.*
5. Press down on the **keypanel key position** where you want the Relay assignment to appear.  
*The key color changes and the alpha appears on the key.*

## Key Assign Menu, Camera ISO

**Camera ISO** assigns an **ISO** (isolate) assignment type to the key. By default, all ISOs are restricted. You must select the appropriate scroll enable check box in AZedit, to see ISOs.

To **assign a Camera ISO to the keypad key**, do the following:

1. Starting at the KeyAssign|Camera ISO menu, select the **ISO** you want to assign to the keypad key.
2. Press the **SEL button**.  
*A list of auto-functions appear.*
3. Using the AUX/MENU shaft encoder, select the **auto-function** you want to assign to the Camera ISO assignment, if applicable.
4. Press the **SEL button**.  
*Tap Key appears in the panel display.*
5. Press down on the **keypanel key position** where you want the Camera ISO assignment to appear.  
*The key color changes and the alpha appears on the key.*

## Key Assign Menu, UPL Resources

**UPL Resources** assigns a key the UPL resource assignment type to the key. By default, all UPL resources are restricted. You must select the appropriate scroll enable check box in AZedit, to see UPLs.

To **assign a UPL to the keypad key**, do the following:

1. Starting at the KeyAssign|UPL menu, select the **UPL** you want to assign to the keypad key.
2. Press the **SEL button**.  
*A list of auto-functions appear.*

**NOTE:** You will not hear anything if you listen to a UPL Resource, but you can activate the UPL with either a talk or listen key.

3. Using the AUX/MENU shaft encoder, select the **auto-function** you want to assign to the UPL assignment, if applicable.
4. Press the **SEL button**.  
*Tap Key appears in the panel display.*
5. Press down on the **keypanel key position** where you want the UPL assignment to appear.  
*The key color changes and the alpha appears on the key.*

## Key Assign Menu, IFB SL

**IFB SL** (IFB Special List) is similar to a special list, except the members of these special lists are IFB assignments. IFB SLs are useful when a producer of a news program needs to talk to all the talent at the same time (most talent assignments are IFB assignments).

To **assign an IFSL to the keypad key**, do the following:

1. Starting at the KeyAssign|IFSL menu, select the **IFSL** you want to assign to the keypad key.
2. Press the **SEL button**.  
*A list of auto-functions appear.*
3. Using the AUX/MENU shaft encoder, select the **auto-function** you want to assign to the IFSL assignment, if applicable.
4. Press the **SEL button**.  
*Tap Key appears in the panel display.*
5. Press down on the **keypanel key position** where you want the IFSL assignment to appear.  
*The key color changes and the alpha appears on the key.*

## Key Assign Menu, Auto Func

**Auto Func** assigns an auto function to the key.

Available options for this menu are:

<i>AF</i>	Auto Follow for listen keys only.	Listens to what is assigned on the Talk key.
<i>AL</i>	Auto Listen for listen keys only.	When Talk is pressed, the Listen turns on.
<i>AM</i>	Auto Mute for listen keys only.	If Listen is active and Talk is pressed, Listen turns off.
<i>AR</i>	Auto Recip for listen keys only.	Listen is always on.
<i>AC</i>	All Call for talk level 1 only.	Turns all Talk keys on to the left of the AC key, up to the next AC key or the end of the row.
<i>Dim</i>	Dim Table function, for talk level 2 on point-to-point keys only.	

To **assign an Auto Function**, do the following:

1. Starting at the KeyAssign|Auto Funcs menu, select the **auto function** you want to assign to the keypad key.
2. Press the **SEL button**.  
*Tap Key appears in the panel display.*
3. Press the **keypanel key** to which you want to assign the auto function.

---

## *Menu System, Key Options Menu*

The **Key Options Menu** is used to configure many of the keypanel operation options, such as auto dial functions, chime keys and duration, exclusive keys, key group assignments, solo key configuration, latching options, button lock, and tally operation.

Available options for this menu are:

*Chime*

*Clear*

*Exclusive*

*Icons*

*Key Groups*

*Latching*

*Lock*

*Solo*

*Tallies*

*Turn Off*

### **Key Options Menu, Chime**

**Chime** indicates a chime tone sounds for incoming call announcements (on specified keys). You can configure the chime tone to activate for a specified amount of time after a call is received.

The range for this field is one (1) second to five (5) minutes, and one-shot.

**NOTE:** Keys that have the currently selected Chime and Duration are shown with a red talk bar. Keys with a different chime or duration are shown with a green talk bar. Keys with no chime do not show a talk bar.

To **add a chime tone to keypanel keys**, do the following:

1. Starting at the Key Options, select **Chime**.
2. Press the **SEL button**.  
*A Chime scroll box and a Duration scroll box appear in the panel display.*
3. Using the AUX/MENU shaft encoder, select the **system chime** you desire (for example, System #1, System #2, System #3, and System #4).
4. Using the AUX/MENU shaft encoder, select the **Duration scroll box**.
5. Press the **SEL button**.
6. Using the AUX/MENU shaft encoder, select the **duration of the chime**.
7. Tap **down** on each keypanel key to which you want to add Chime.

**NOTE:** Assigning <none> clears the chime from the key. When you change chime types, if Preview is enabled, you hear the chime play. Also, if you lift the listen key for any key showing it has a chime assigned, you hear the chime associated with that key.



## Key Options Menu, Clear

The **Clear** menu option is used to clear any key options or clear UPG key programming that have been assigned to a specific key.

To **clear a key's key options**, do the following:

1. Starting at the Key Options menu, select **Clear**.
2. Press the **SEL button**.  
*Tap Key appears in the panel display.*
3. Tap the **key** you want to clear the key options from.  
*The key options are removed from the keypad key.*
4. Press the **CLR button** to exit the menu structure.

To **clear UPG key programming**, do the following:

1. Starting at the Key Options menu, select **Clear**.
2. Press the **SEL button**.  
*Tap Key appears in the panel display.*
3. Press the **UPG key you want to clear** the UPG programming from.  
*The key options are removed from the keypad key.*
4. Press the **CLR button** to exit the menu structure.

## Key Options Menu, Exclusive

**Exclusive** allows the user to set up keys that cause any other exclusive keys to turn off when activated. Unlike the solo option, when the exclusive option is deactivated, the other exclusive key turns off and does not turn back on. You can assign multiple exclusive keys.

To **create an exclusive key assignment**, do the following:

1. Starting at the Key Options menu, select **Exclusive**.
2. Press the **SEL button**.  
*Tap Key appears in the panel display.*
3. Tap **down** on any keypad key you want to assign the exclusive key option.  
*The key display turns red.*

To **remove an exclusive key assignment**, do the following:







1. Starting at the Key Options menu, select **Exclusive**.
2. Press the **SEL button**.  
*Tap Key appears in the panel display.*
3. Tap **down** on each red keypad key from which you want to remove the exclusive key option.  
*The selected keys return to the unassigned state (light blue color).*

## Key Options Menu, Icons

The **Icons** menu option is used to enable icon overlays for various key states. There are seven (7) key states that can be indicated using an icon.

By default, icons are enabled, which means they are displayed.

The icons available are:

	Gold Star	Key is Solo Key
	Black Phone	Key has TIF Assignment
	Globe	Key has Remote/Trunk assignment
	Bell	Key has Chime
	Plus	Key is Group Master
	Minus	Key is Exclusive

To **enable/disable icon overlays**, do the following:

1. Starting at the Key Options menu, select **Icons**.
2. Press the **SEL button**.  
*An Icon scroll box and a Display scroll box appear in the panel display.*
3. Using the AUX/MENU shaft encoder, select the **key state** you want from the Icon scroll box.
4. Using the AUX/MENU shaft encoder, select **Display**.
5. Press the **SEL button**.
6. Using the AUX/MENU shaft encoder, select **Enable** to display the icon.  
OR  
Using the AUX/MENU shaft encoder, select **Disable** to hide the icon.
7. Repeat **steps 3 through 5** until you are finished.

## Key Options Menu, Key Groups

**Key Groups** is used to create a key group. A key group allows the user to activate a group of keys by activating one (1) key (the master key). When the master key is activated, all keys in the group become active.

You can create *up to four (4) key groups*.

To **create a key group**, do the following:

1. Starting at the Key Options|Key Groups menu, select the **Group** (1–4) you want to create.
2. Press the **SEL button**.  
*Tap Master Key appears in the panel display.*
3. Tap **down on the keypad key** you want to act as the master key.  
OR  
Press **SEL** to skip creating a Master key  
*The selected key displays a red talk bar and Tap Slave Key(s) appears in the panel display.*

**NOTE:** A group without a master key cannot be activated by a key press, but may still be activated by a GPI Input.

4. Tap **down on the keypad keys** you want to be activated when the master key is selected.  
*The selected keys displays a green talk or listen bar*

To **delete a key group**, do the following:

1. Starting at the Key Options|Key Groups menu, select the **Group** (1-4) you want to delete.
2. Press the **SEL button**.  
*Tap the Master Key appears in the panel display.*
3. Press the **SEL key**.  
*The selected key loses its red talk bar and Tap Slave Key(s) appears in the panel display.*
4. Tap **down on the green keypad keys** you want to remove from the group.  
*The selected keys lose their green talk or listen bar.*

## Key Options Menu, Latching

**Latching** is used to enable or disable the keypad key to stay on when pressed. When Latching is enabled, the talk function stays on after the talk key is pressed briefly. Otherwise, the talk function only works when the button is pressed. You configure globally across all keys, or on a per key basis.

**NOTE:** A key only latches if it is pressed and released within 0.5 seconds. Otherwise, the key always turns off when released.

By default, latching is *enabled*.

To **set latching on a keypad key**, do the following:

1. Starting at the Key Options menu, select **Latching**.
2. Press the **SEL button**.  
*Global and Per Key appear in the panel display.*
3. Using the AUX/MENU shaft encoder, select either **Global** or **Per Key**.

**NOTE:** When Per Key is selected, you need to tap each key to change the latch enable state.

4. Press the **SEL button**.  
*Disabled and Enabled appear in the panel display.*
5. Using the AUX/MENU shaft encoder, select **Enabled** or **Disabled**.  
*An arrow appears next to the selected option.*

## Key Options Menu, Lock (Button Lock)

**Lock** is used to lock keypad keys in the on or off position. Each key may be independently locked on or off.

To **lock a button on**, do the following:

1. Starting at the Key Options| menu, select **Lock**.
2. Press the **SEL button**.  
*Tap Key appears in the panel display.*
3. Tap a **key** once to lock it on.  
*A green indicator appears. This indicates the key is locked on.*  
OR  
Tap the **key again** to lock it off.  
*A red indicator appears indicating the key is locked off, meaning the user cannot turn the key on or off.*  
OR  
Tap the **key again** to release the lock.

## Key Options Menu, Solo

**Solo** allows the user to set up a key that causes all other keys to turn off when activated. However, when the solo key is released, the keys that were turned off by the solo key turn back on.

You can assign only one (1) solo key.

To **create a solo key**, do the following:

1. Starting at the Key Options menu, select **Solo**.
2. Press the **SEL button**.  
*Tap Key appears in the panel display.*
3. Tap **down on the keypad key** you want to configure as solo.  
*The selected talk key indicator turns red.*

To **remove a solo key**, do the following:

1. Starting at the Key Options menu, select **Solo**.
2. Press the **SEL button**.  
*Tap Key appears in the panel display.*
3. Tap **down on the red solo keypad key** you want to remove the solo assignment.  
*The selected talk key indicator turns red.*

## Key Options Menu, Tallies

**Tallies** are used to indicate incoming calls with blinking alpha assignments. You can configure tally time as 5, 10, or 15 seconds or set it as indefinite.

If indefinite is selected, when a caller presses and releases the talk key, a tally with a minimum duration appears. If the call is answered before the minimum duration is met, the tally is cancelled. However, if indefinite is selected and a caller presses and holds (or latches) the talk key, the tally continues until the caller releases the key. This means the tally continues through the call if the caller does not release the key.

**NOTE:** When KP-3016/3016A keypanels are connected to legacy intercoms (for example, intercoms that do not support Enhanced Tallies, the available options for this menu are relevant.

When KP-3016/3016A keypanels are connected to intercoms that support Enhanced Tallies, the Enhanced Tallies view allows you to globally configure how the tally behaves. (the options in the Tally menu in the keypanel are not relevant). For more information, see “Enhanced Tallies” on page 56.

By default, tallies are set to *15 seconds*.

To **set the tally time on an incoming call**, do the following:

1. Starting at the Key Options|Tallies menu, select **Min Duration**.
2. Press the **SEL button**.  
*A Min Duration scroll box appears in the panel display.*
3. Using the AUX/MENU shaft encoder, select the **duration** you desire.

To **set the tally time to indefinite on an incoming call**, do the following:

1. Starting at the Key Options|Tallies menu, select **Indefinite**.
2. Press the **SEL button**.  
*Disabled and Enabled appear in the panel display.*
3. Using the AUX/MENU shaft encoder, select **Disable** or **Enable**.

## Key Options Menu, Turn Off

The **Turn Off** menu item allows the user to quickly turn off all keys, all talk keys, or all listen keys.

To **turn off keys on the keypanel using the menu**, do the following:

1. Starting at the Key Options|Turn Off menu, select **All Keys**, **Talk Keys**, or **Listen Keys**.
2. Press the **SEL button**.  
*Turn Keys Off? appears in the keypanel panel display.*
3. Press the **SEL button**.  
*Keys Turned Off appears in the keypanel panel display.*

---

## *Menu System, OMNEO Offers (Only available for KP-3016)*

The **OMNEO Offers** menu item is used to configure the keypanel to communicate with the matrix via an OMNEO or AIO connection. From this menu, you can also configure the OMNEO channels to be used for AUX Inputs.

### **OMNEO Matrix Connection Configuration**

To **configure an available OMNEO device connection port**, do the following:

1. Starting at the OMNEO Offers|Keypanel menu, select **OKP**.
2. Press the **SEL button**.  
*A list of available OMNEO devices appears.*
3. Using the AUX/MENU shaft encoder, select the **OMNEO device** you want to use.  
*An arrow appears next to the device.*
4. Press **CLR** to exit menu mode.

### **OMNEO Aux Port Configuration**

To **configure the OMNEO channels as Aux Inputs**, do the following:

1. Starting at the OMNEO Offers|Keypanel menu, select **Aux Input**.
2. Press the **SEL button**.  
*OMNEO 1 and OMNEO 2 appears in the panel display.*
3. Using the AUX/MENU shaft encoder, select **OMNEO 1** or **OMNEO 2**.
4. Press the **SEL button**.  
*A list of available OMNEO offers appears in the panel display.*
5. Using the AUX/MENU shaft encoder, select the **OMNEO offer** you want to configure as an Aux Input.
6. Press the **SEL button**.  
*The OMNEO Aux Input is configured.*

---

## *Menu System, RVON Offers (Only available when an RVON-I/O is detected)*

The **RVON Offers** menu item is used to configure the matrix connection when an RVON-I/O is attached to the AIO port on the back of the keypanel.

### **RVON-I/O Matrix Connection**

*RVON-I/O* RVON-16, RVON-8, RVON-C, and RVON-I/O (in local mode). Use the Frame connection on the back panel of the keypanel.

**NOTE:** For more information about RVON-I/O configuration, see the RVON-I/O user manual (F.01U.193.280).

To **configure the Matrix connection port**, do the following:

1. Starting at the RVON Offers|Keypanel menu, select the **Matrix connection type** you want to use.

**NOTE:** If an RVON-I/O is connected to the keypanel, RVON-I/O replaces the AIO menu option.

2. Using the AUX/MENU shaft encoder, select the **port** you want to use.  
*An arrow appears next to the port.*

---

## *Menu System, Save Config*

The **Save Config** menu option is used to save custom settings made in the Audio Options, Key Options or Service menus. Once you have made modifications via these menus, run Save Cfg to store the custom settings in non-volatile memory. This ensures your custom settings are saved when the keypad is powered down. You can run Reset Config (see “Service Menu, Reset Cfg” on page 131), to erase all custom settings.

To **run a save config**, do the following:

1. On the keypad, press **MENU**.  
*The main menu appears.*
2. Using the AUX/MENU shaft encoder, select **Save Config**.
3. Press the **SEL button**.  
*Configuration Saved appears in the panel display.*

---

## Menu System, Service

The information available for key assign is as follows:

*Alphas*  
*Display*  
*Intercom Mode*  
*Key View*  
*Keypad*  
*LCD Backlight*  
*OMNEO Setup (only available for KP-3016)*  
*Page Change*  
*Reset Cfg*  
*RVON Setup*  
*Scrn Saver*  
*Set Address*  
*Snoop Tally*  
*Test Panel*

### Service Menu, Alphas

The **Alphas** menu is used to select the alpha size (length) and type to be displayed for key assignments.

**NOTE:** When a Reset Cfg is performed, the Alpha Size and Poll ID do not get reset.

Available options are:

*4 Chars*  
*6 Chars*  
*8 Chars*  
*8 Chars (Unicode)*

**IMPORTANT:** Keypanel on the same AIO-8, or on the same group of eight (8) on an AIO-16, Zeus I/II (but not III), or ADAM CS must have the same alpha size selected. But each group of eight (8) can support a different alpha size.

To **set the alpha size**, do the following:

1. Starting at the Service|Alphas menu, select **4 Chars, 6 Chars, 8 Char, or 8 Chars (Unicode)**.
2. Press the **SEL button**.  
*Cancel and Save and Restart appear in the panel display.*
3. Using the AUX/MENU shaft encoder, select **Save and Restart**.
4. Press the **SEL button**.  
*The keypad restarts itself with the new alpha size.*



## Service Menu, Display

The **Display** menu is used to enable the menu context, display speaker volume and to switch the display to emulate a KP-32 keypanel.

### *Display Volume*

The **Display Volume** feature is used to enable always-on display of the volume bar for Headset, Matrix, or Speaker, depending on what is selected from the encoder knobs.

### *KP32 Emulation*

The **KP32 Emulation** is used to switch the display alphas and background to emulate the KP32 with the black background and green lettering.

**IMPORTANT:** Only the display of key and key assignment changes, the menu structure and other display elements do not revert to the KP32 display.

To **activate KP32 Emulation**, do the following:

1. Starting at the Service|Display menu, select **KP32 Emulation**.
2. Press the **SEL button**.  
*Disabled and Enabled appear in the panel display.*
3. Using the AUX/MENU shaft encoder, select **Enabled**.
4. Press the **SEL button**.  
*The display panel changes to the KP32 Emulation mode.*

## Service Menu, Intercom Mode

The **Intercom Mode** menu is used to select the type of firmware you have in your intercom so the keypanel can display alphas in the correct font/language and modify the behavior of some functions to match the intercom behavior.

Available options are *Alternate* and *Standard*.

**NOTE:** Standard mode is the default and should be used in most cases. Alternate mode is primarily used for intercoms running Japanese firmware.

To **select the intercom mode**, do the following:

1. Starting at the Service|Intercom Mode menu, select **Alternate** or **Standard**.  
*An arrow appears next to selected option.*
2. Press the **SEL button**.  
*The selections Cancel and Save and Restart appear.*
3. Using the AUX/MENU shaft encoder, select **Cancel** to cancel out of the action.  
OR  
Using the AUX/MENU shaft encoder, select **Save and Restart** to save the changes.
4. Press the **SEL button**.

## Service Menu, Key View

The **Key View** menu is used to configure the keypad keys to show key crosspoint gains, show listen assignments, or show the matrix for each key assignment.

**NOTE:** Show Lstn and Show Mtx are mutually exclusive options. Only one (1) of these options may be enabled at a time.

Available options for this menu are:

<i>Show Gain</i>	The crosspoint gain bar graph for each key is shown below the talk assignment.
<i>Show Lstn</i>	The listen assignment for each key is shown above the talk assignment.
<i>Show Mtx</i>	The matrix name for each key assignment is shown above the talk assignment.

---

**IMPORTANT:** When the keypad is configured for 8 Char or 8 Char (Unicode), none of these options are available.

---

To **configure the Key View**, do the following:

1. Starting at the Service menu, select **Key View**.
2. Press the **SEL button**.  
*Show Gain, Show Lstn, and Show Mtx appear in the panel display.*
3. Using the AUX/MENU shaft encoder, select **Show Gain** to show gain on the key display.  
OR  
Using the AUX/MENU shaft encoder, select **Show Lstn** to show listen assignments on the key display.  
OR  
Using the AUX/MENU shaft encoder, select **Show Mtx** to show the matrix assignments on the key display.
4. Press the **SEL button**.  
*Disabled and Enabled appear in the panel display.*
5. Using the AUX/MENU shaft encoder, select **Enabled** or **Disabled**.
6. Press the **SEL button**.  
*An arrow appears next the selected option.*

## Service Menu, Keypad

The **Keypad** menu is used to configure the look and behavior of the keypad.

### *Backlight*

The **Backlight** menu is used to select the color and brightness of the keypad backlight LEDs at various usage states and to configure the keypad mode.

#### *Setup*

The **Setup** menu allows you to configure the color and brightness of the keypad backlight LEDs various actions are performed on the keypad.

Brightness ranges from 0% to 100%.

By default, brightness is set to 30% for the Inactive state; and 100% for the Active and Shift states.

Available options for this menu are:

<i>Inactive</i>	Set the color and brightness of the keypad backlight LEDs when the keypad is in the inactive state.
<i>Active</i>	Set the color and brightness of the keypad backlight LEDs when the keypad is in the active state.
<i>Shift State</i>	Set the color and brightness of the keypad backlight LEDs when the keypad is in the SHIFT state. For more information, see “INFO button” on page 34.

#### *Activation*

The **Activation** menu is used to configure how and when the keypad backlights. When Activate is selected, the backlight activates when the user presses any keypad key on the keypad. Within the Activate menu, you can select whether the first key is processed or swallowed.

Available selections for this field are:

<i>On Keypress (swallowed)</i> –	The first keypad key pushed when the keypad is Inactive is only used to activate the keypad, the actual keypad key push event is not acted upon.  Note, this action activates the keypad (so the next key is processed), but it may not do anything to the backlight.
<i>On Keypress (processed)</i> –	The first keypad key pushed when the keypad is Inactive activates the keypad and then is processed.
<i>Always</i>	The keypad backlight is always in the active state.
<i>Never</i>	The keypad backlight is always in the inactive state.

**NOTE:** When the keypad menu is not active, the backlight stays lit for five (5) seconds of inactivity before returning to the inactive state. However, when the keypad menu is active, the backlight stays lit for one (1) minute before exiting the menu system and returning to the inactive state.

To **configure the Keypad Setup option**, do the following:

1. Starting at the Service| menu, select **Backlight**.
2. Press the **SEL button**.  
*Activation and Setup appear in the panel display.*
3. Using the AUX/MENU shaft encoder, select **Setup**.
4. Press the **SEL button**.  
*Inactive, Active, and Shift State appear in the panel display.*
5. Using the AUX/MENU shaft encoder, select **Inactive**, **Active**, or **Shift State**.
6. Press the **SEL button**.  
*The Brightness scroll box and the Color scroll box appear in the panel display.*
7. Using the AUX/MENU shaft encoder, select the **brightness** you desire.
8. Press the **SEL button**.
9. Using the AUX/MENU shaft encoder, select the **color scroll box**.
10. Press the **SEL button**.
11. Using the AUX/MENU encoder knob, select the **color** you desire.
12. Press the **SEL button**.

To **set the keypad Activation option**, do the following:

1. Starting at the Service| menu, select **Backlight**.
2. Press the **SEL button**.  
*Activation and Setup appear in the panel display.*
3. Using the AUX/MENU shaft encoder, select **Activation**.
4. Press the **SEL button**.  
*Activated (d), Always Inactive, and Always Active appear in the panel display.*
5. Using the AUX/MENU shaft encoder, select **Always Active** to have the keypad backlight always on.  
OR  
Using the AUX/MENU shaft encoder, select **Always Inactive** to have the keypad backlight never on.  
OR  
Using the AUX/MENU shaft encoder, select **Activated** to have the keypad turn on when the keypad is pressed.

If **Activated** is selected, do the following

- a. Press the **SEL button**.  
*Processed First Press and Swallow First Press appear in the panel display.*
  - b. Using the AUX/MENU shaft encoder, select **Processed First Press** or **Swallow First Press**.
6. Press the **SEL button**.  
*An arrow appears next the selected option.*

### **SEL Key**

The **SEL Key** menu allows the user to choose what function the SEL key performs when not in menu mode. This menu allows you to set up the SEL key functionality.

Available selections for this field are:

<i>Auto (d)</i>	The key function is automatically selected based on whether you are in Standard or Alternate intercom mode. In Standard mode, the SEL key is assigned Assignment Group functionality, while in Alternate mode, the SEL key is assigned Quick Assign functionality.
<i>Assignment Groups</i>	The key function is given Assignment Groups. This displays the scroll lists of a collection of user-selectable key assignments. When you select a group, a scroll list of the members of the group appear, which then can be called or programmed onto a key. For more information see, "Assignment Groups Page" on page 53.
<i>Quick Assign</i>	The key function is given Quick Assign. When you configure the SEL key with Quick Assign, you are actually selecting your most used key type, for example, P-P with AL. When the SEL key is pressed with a quick assign configured to it, a menu appears with Assign or Clear. The user can then quickly configure a key with a pre-configured assignment by selecting Assign, or clear the key assignment by selecting Clear.

### **Service Menu, LCD Backlight**

The **LCD Backlight** menu option allows you to set the brightness of the panel display of all keypanels, just the main panel or an expansion panel connected to the main keypanel.

The range for this field is 35–100%.

The default is 65%.

To **configure the LCD backlight**, do the following:

1. Starting at the Service| menu, select **Backlight**.
2. Press the **SEL button**.  
*All Panels, Main Panel, EKP appears in the panel display.*
3. Using the AUX/MENU shaft encoder, select the **panel** you want to adjust the brightness.  
If you select All Panels, continue to **step 4**.  
If you select Main Panel or EKP, do the following:
  - a. Press the **SEL button**.  
*Both, Left and Right appear in the panel display.*
  - b. Using the AUX/MENU shaft encoder, select **Both, Left or Right**.  
*Continue to step 4.*
4. Press the **SEL button**.  
*The Brightness scroll box appears in the panel display.*
5. Using the AUX/MENU shaft encoder, select the **brightness** you want to display.

## Service Menu, OMNEO Setup (KP-3016 Only)

The **OMNEO Setup** menu option is used to configure the OMNEO device name, enable DHCP, address the OMNEO device for the keypanel and set up the static IP configuration, if DHCP is disabled.

---

**IMPORTANT:** If you change the device name on the keypanel, you must change how other device are configured, so they can continue to make connection offers to this keypanel.

---

To **enable DHCP from the keypanel**, do the following:

1. Starting at the Service|OMNEO Setup menu, select **OKP**.

**NOTE:** OKP refers to the OMNEO keypanel using the OMNEO connection; however, if an OEI-2 is also attached to the AIO port, you see both OKP and OEI-2 options for selection.

2. Press the **SEL button**.  
*Device Name, DHCP, and IP Parameters appear in the panel display.*
3. Using the AUX/MENU shaft encoder, select **DHCP**.
4. Press the **SEL button**.  
*Disabled and Enabled appear in the panel display.*
5. Using the AUX/MENU shaft encoder, select **Enabled**.
6. Press the **SEL button**.
7. Press the **CLR** button to exit the menu.

To **configure the OKP's device name**, do the following:

1. Starting at the Service|OMNEO Setup menu, select **OKP**.
2. Press the **SEL button**.  
*Device Name, DHCP, and IP Parameters appear in the panel display.*
3. Using the AUX/MENU shaft encoder, select **Device Name**.  
*The name of the OKP card appears in the panel display with the first character of its name blinking.*
4. Using the AUX/MENU shaft encoder, select a **new character at the current position**.
5. Using the MAIN shaft encoder, move to the **next or previous character position**.
6. Press **SHIFT** to insert a character at the current position.
7. Press the **SEL button**.  
OR  
Press the **AUX** shaft encoder to move to the next character.

**NOTE:** Press the MAIN shaft encoder to cancel editing. A confirmation is required.

8. Repeat **steps 4** and **7** until you have modified the device name.
9. Move to the end of the name and press the **SEL button** (or the AUX shaft encoder) to save changes.  
*The message Save Name? appears on the panel display.*
10. Press the **SEL button**.

To **configure the OKP IP parameters**, do the following:

1. Starting at the Service|OMNEO Setup menu, select **OKP**.
2. Press the **SEL button**.  
*Device Name, DHCP, and IP Parameters appear in the panel display.*
3. Using the AUX/MENU shaft encoder, select **DHCP**.
4. Press the **SEL button**.  
*Disabled and Enabled appear in the panel display.*

5. Verify **DHCP is disabled**.

**NOTE:** When making changes to the OKP IP parameters, DHCP must be disabled before changing the Domain name or IP Address. If DHCP is enabled, you can still view the IP Parameters, but you cannot make changes to them.

6. Press **CLR**.
7. Using the AUX/MENU shaft encoder, select **IP Parameters**.

**NOTE:**

- Pressing the SEL key or a single-tap to the AUX/MENU shaft encoder moves the focus to the next octet, unless already on the last octet, in which case it saves the current IP Address.
  - Pressing the CLR key, double-tapping the AUX/MENU shaft encoder, or single-tapping the MAIN shaft encoder moves the focus to the previous octet, unless already on the first octet, in which case it cancels editing of the IP Address.
8. Press the **SEL button**.  
*IP Address, Gateway, Netmask, Domain, and DNS Server appear in the panel display.*
  9. Press the **SEL button**.  
*The IP Address appears with the first octet blinking in the panel display.*
  10. Using the AUX/MENU shaft encoder, enter the **first octet number** in the IP Address.
  11. Press the **SEL button**.  
*The focus shifts to the second octet.*
  12. Using the AUX/MENU shaft encoder, enter the **second octet number** in the IP Address.
  13. Press the **SEL button**.  
*The focus shifts to the third octet.*
  14. Using the AUX/MENU shaft encoder, enter the **third octet number** in the IP Address.
  15. Press the **SEL button**.  
*The focus shifts to the last octet.*
  16. Using the AUX/MENU shaft encoder, enter the **last octet number** in the IP Address.
  17. Press the **SEL button**.  
*The OMNEO Setup menu options appear in the panel display.*

To **configure the Gateway Address**, do the following:

1. Using the AUX/MENU shaft encoder, select **Gateway**.
2. Press the **SEL button**.  
*The Gateway Address appears with the first octet blinking in the panel display.*
3. Using the AUX/MENU shaft encoder, enter the **first octet number** in the Gateway Address.
4. Press the **SEL button**.  
*The focus shifts to the second octet.*
5. Using the AUX/MENU shaft encoder, enter the **second octet number** in the Gateway Address.
6. Press the **SEL button**.  
*The focus shifts to the third octet.*
7. Using the AUX/MENU shaft encoder, enter the **third octet number** in the Gateway Address.
8. Press the **SEL button**.  
*The focus shifts to the last octet.*
9. Using the AUX/MENU shaft encoder, enter the **last octet number** in the Gateway Address.
10. Press the **SEL button**.  
*The OKP Setup menu options appear in the panel display.*

To **configure the Netmask Address**, do the following:

1. Using the AUX/MENU shaft encoder, select **Netmask**.
2. Press the **SEL button**.  
*The Netmask Address appears with the first octet blinking in the panel display.*
3. Using the AUX/MENU shaft encoder, enter the **first octet number** in the Netmask Address.
4. Press the **SEL button**.  
*The focus shifts to the second octet.*
5. Using the AUX/MENU shaft encoder, enter the **second octet number** in the Netmask Address.
6. Press the **SEL button**.  
*The focus shifts to the third octet.*
7. Using the AUX/MENU shaft encoder, enter the **third octet number** in the Netmask Address.
8. Press the **SEL button**.  
*The focus shifts to the last octet.*
9. Using the AUX/MENU shaft encoder, enter the **last octet number** in the Netmask Address.
10. Press the **SEL button**.  
*The RVON Setup menu options appear in the panel display.*
11. Press **CLR** to exit menu mode.

To **configure the Domain name**, do the following:

1. Using the AUX/MENU shaft encoder, select **Domain**.
2. Press the **SEL button**.  
*The domain name appears with the first character blinking in the panel display.*
3. Using the AUX/MENU shaft encoder, select a **new character at the current position**.
4. Press the **SEL button**.
5. Using the AUX/MENU shaft encoder, move to the **next or previous character position**.
6. Press **SHIFT** to insert a character at the current position.
7. Press the **SEL button**  
OR  
Press the **AUX** shaft encoder to move to the next character.

**NOTE:** Press the MAIN shaft encoder to cancel editing. A confirmation is required.

8. Repeat **steps 3 to 6** until the domain is named.
9. Once finished, press the **SEL button**.  
*Save Name? appears in the panel display.*
10. Press the **SEL button**.

To **configure DNS Server**, do the following:

1. Using the AUX/MENU shaft encoder, select **DNS Server**.
2. Press the **SEL button**.  
*The DNS Server Address appears with the first octet blinking in the panel display.*
3. Using the AUX/MENU shaft encoder, enter the **first octet number** in the DNS Address.
4. Press the **SEL button**.  
*The focus shifts to the second octet.*
5. Using the AUX/MENU shaft encoder, enter the **second octet number** in the DNS Address.
6. Press the **SEL button**.  
*The focus shifts to the third octet.*
7. Using the AUX/MENU shaft encoder, enter the **third octet number** in the DNS Address.
8. Press the **SEL button**.  
*The focus shifts to the last octet.*



9. Using the AUX/MENU shaft encoder, enter the **last octet number** in the DNS Address.
10. Press the **SEL button**.  
*The OMNEO Setup menu options appear in the panel display.*
11. Press **CLR** to exit menu mode.

### Service Menu, Page Change

**Page Change** is used to select whether you are allowed to change setup pages while talk keys are active. By default, in Standard Intercom Mode, page changes are allowed when talk keys are active. However, the default in Alternate Intercom Mode does not allow page changes to occur when talk keys are active.

Available options:

<i>Auto</i>	The default is followed depending on the Intercom Mode: Standard or Alternate.
<i>Always Allow</i>	Page changes are allowed while Talk Keys are active.
<i>No Talk Keys</i>	Page changes are not allowed while Talk Keys are active. A red bar appears above/below the keys signifying page changes are not allowed. If the talk key is turned off, the red bar turns blue and page changes can be done.

To **configure page change operation**, do the following:

1. Starting at the Service|Page Change menu, select **Page Change**.
2. Press the **SEL button**.  
*Auto, Always Allow, and No Talk Keys appear.*
3. Using the AUX/MENU shaft encoder, select the **page change option** you desire.
4. Press the **SEL button**.  
*An arrow appears next to the selected option.*

### Service Menu, Reset Cfg

**Reset Cfg** restores almost all custom settings to the defaults and erases all stored autodial numbers. Reset Cfg does not change the selected alpha size, intercom mode, poll ID, or headset transfer state.

To **reset the keypanel configuration**, do the following:

1. Starting at the Service|Reset Cfg menu, select **Do Reset**.
2. Press the **SEL button**.  
*Configuration Reset appears in the panel display.*

## Service Menu, Scrn Saver

**Scr Saver** allows the user to configure the way the screen saver feature operates.

Available selections for this menu are:

<i>Activate</i>	Allows the user to activate the screen saver immediately (used to test current display settings).
<i>Delay</i>	Allows the user to set the delay for Display Dim (for example, when the display will dim) and to set the delay for Activation (for example, when the screen saver becomes active). Both features can be set from 30 minutes, up to 12 hours, or disabled.
<i>Display Dim</i>	Allows the user to set the brightness of the panel display from 0-100%. This setting is a percentage of the current LCD brightness. For example, if you configured your backlight for 60%, then in this menu, 100% is equal to 60% and 0% is equal to 35%.
<i>Mode</i>	Can be set to Bitmap, Display Off (sleep mode), or Text.

The default setting for this option is:

<i>Delay</i>	<i>One (1) hour for both display dim and screen-saver activation</i>
<i>Display Dim</i>	<i>25%</i>
<i>Mode</i>	<i>Text</i>

**NOTE:** Activating any lever key, button, or shaft encoder deactivates the screen-saver, as will an incoming call.

To **manually activate the screen saver**, do the following:

1. Starting at the Service|Scrn Saver menu, select **Activate**.
2. Press the **SEL button**.  
*The screen saver is activated on the keypad panel display.*

To **set the delay option for the keypad screen saver**, do the following:

1. Starting at the Service|Scrn Saver menu, select **Delay**.
2. Press the **SEL button**.  
*Display Dim and Activation appear in panel display.*
3. Using the AUX/MENU shaft encoder, select **Display Dim**.
4. Press the **SEL button**.  
*The Delay Time: scroll box appears in the panel display.*
5. Using the AUX/MENU shaft encoder, select the **amount of time** you want to expire before the display dims.
6. Press **CLR**.  
*Display Dim and Activation appear in panel display.*
7. Using the AUX/MENU shaft encoder, select **Activation**.
8. Press the **SEL button**.  
*The Delay Time: scroll box appears in the panel display.*
9. Using the AUX/MENU shaft encoder, select the **amount of time** you want to expire before the screen saver becomes active.

To **set the brightness of the display**, do the following:

1. Starting at the Service|Scrn Saver menu, select **Display Dim**.
2. Press the **SEL button**.  
*The Brightness scroll box appears in the panel display.*
3. Using the AUX/MENU shaft encoder, scroll to the **display brightness** you desire.

To **set the screen saver mode (type)**, do the following:

1. Starting at the Service|Scrn Saver menu, select **Mode**.
2. Press the **SEL button**.  
*Bitmap, Display Off and Text appear in the panel display.*
3. Using the AUX/MENU shaft encoder, select **Bitmap** to have a bitmap image display when the screen saver activates.  
OR  
Using the AUX/MENU shaft encoder, select **Display Off** to put the display into sleep mode when the screen saver activates.  
OR  
Using the AUX/MENU shaft encoder, select **Text** to have a text message display when the screen saver activates.
4. Press the **SEL button**.  
*If Bitmap or Text is selected, the options Bounce or Scroll appear.*
5. Using the AUX/MENU shaft encoder, select **Bounce** to have the bitmap or text bounce across the display.  
OR  
Using the AUX/MENU shaft encoder, select **Scroll** to have the bitmap or text scroll across the display.

### Service Menu, Set Address

**Set Address** is used to indicate the poll ID of the keypanel. See “KP-3016/3016A Addressing” on page 22 to determine if you need to set the keypanel address. The poll ID is the number (or address) at which an AIO card or intercom attempts to communicate with the keypanel. The Poll ID number is directly related to the connection port on the breakout panel.

Available options for the Poll ID are 1–8.

To **set the address**, do the following:

1. Starting at the Service|Set Address menu, select the **poll ID** for the keypanel.
2. Press the **SEL button**.  
*Cancel or Save and Restart appear in the panel display.*
3. Using the AUX/MENU shaft encoder, scroll to **Save and Restart**.
4. Press the **SEL button**.  
*Restarting.... appears. The keypanel resets. Once the restart is complete, the Poll ID is enabled.*

## Service Menu, Snoop Tally

**Snoop Tally**, when enabled, indicates to keypanel users somebody is listening to them. For example, snoop tallies are displayed on keypanel 1, if there is another keypanel (2) which is listening to keypanel 1 via a point-to-point or a special list, but is not talking to keypanel 1. Snoop tallies are suppressed if keypanel 1 has any talk keys turned on, or if the hot mic is not enabled.

From this menu, you can set the type of chime indication you want and the duration of the tally.

Available Tally durations available are: *One-shot* and *1 second to 5 minutes*.

**NOTE:** Hot Mic must be activated on the keypanel for snoop tally to work. For more information, see “Audio Options Menu, Matrix Out” on page 101.

By default, snoop tally is *disabled* (no chime).



To **enable snoop tallies on the keypanel**, do the following:

1. Starting at the Service menu, select **Snoop Tally**.
2. Press the **SEL button**.  
*The Chime scroll box and the Duration scroll appear in the panel display.*
3. Using the AUX/MENU shaft encoder, select the **type of chime** you desire.
4. Press the **SEL button**.
5. Using the AUX/MENU shaft encoder, select **Duration**.
6. Press the **SEL button**.
7. Using the AUX/MENU encoder knob, select the **duration** of the tally.

## Service Menu, Test Panel

**Test Panel** allows the user to check the operation of all keys and displays on the keypad.

**TABLE 10.** Test Panel Key Descriptions

Display	Action
	All alpha numeric displays show a % symbol when in Test Panel mode.
	Press down on any key.
	Press up on any key.
<MENU>	Single tap the Aux Volume encoder knob
<-MENU>	Rotate the Aux Volume encoder knob counterclockwise.
<+MENU>	Rotate the Aux Volume encoder knob clockwise.
<MENU-DBL>	Double tap the Aux Volume encoder knob
<MENU- HELD>	Press and Hold the Aux Volume encoder knob
<MAIN>	Single tap the Aux Volume encoder knob
<-MAIN>	Rotate the Main Volume encoder knob counterclockwise.
<+MAIN>	Rotate the Main Volume encoder knob clockwise.
<MAIN-DBL>	Double tap the Main Volume encoder knob
<MAIN- HELD>	Press and Hold the Main Volume encoder knob
<MUTE>	Press up on the MIC MUTE/MIC SEL. key.
<MIC>	Press down on the MIC MUTE/MIC SEL. key.
<CLR>	Press up on the CLR/CWW key.
<CWW>	Press down on the CLR/CWW key.

To **enable the test panel**, do the following:

1. On the keypad, press **MENU**.  
*The Information menu appears in the panel display.*
2. Using the AUX/MENU shaft encoder, select **Service**.
3. Press the **SEL button**.  
*The Service submenu appears in the panel display.*
4. Using the AUX/MENU shaft encoder, select **Test Panel**.
5. Press the **SEL button**.  
*The Test Panel display appears.*
6. Using Table 10 on page 135, test the **keypanel keys**.



## *Centralized Auto-Dialing*

---

**IMPORTANT:** Telephone operation requires an optional **TIF** (Telephone Interface). You must assign an intercom key to talk/listen to the TIF. We recommend a talk + auto follow assignment. See the TIF User Manual (PN F01U193285) for specific TIF configuration options.

---

---

### *Centralized Auto Dials*

The **Centralized Auto Dials** allows up to 999 phone numbers to be stored in the intercom as a scrollable list from the keypanels. Auto dials are telephone numbers frequently dialed and are maintained using the AZedit Intercom Configuration Software. Customizing auto dial numbers in AZedit is as easy as entering the telephone number and selecting whether or not it is scroll enabled.

The following firmware versions must be loaded to utilize centralized auto dials in your intercom system:

- AZedit Intercom Software V3.6.1 or later
- MCII-e V2.0.4 or later
- PeriphII-e (Ethernet) V1.20.0 or later
- Periph Controller (Standard) V10.20.0 or later
- DBX V1.20.0 or later
- Cronus Firmware V1.5 or later
- Zeus II Firmware V3.4.0 or later
- Zeus III Firmware V1.0.0 or later
- KP 32 CLD Firmware V1.3.0 or later
- KP-3016/3016A Firmware V1.1.0 or later

## Centralized Auto Dial

The **Centralized Auto Dial** can be used with TIF assignments. You can also configure locally stored auto dial numbers on the keypanel.

To **access the Auto Dials window**, do the following:

- > From the System menu in AZedit, select **Auto Dial**.  
*The Auto Dials window appears.*

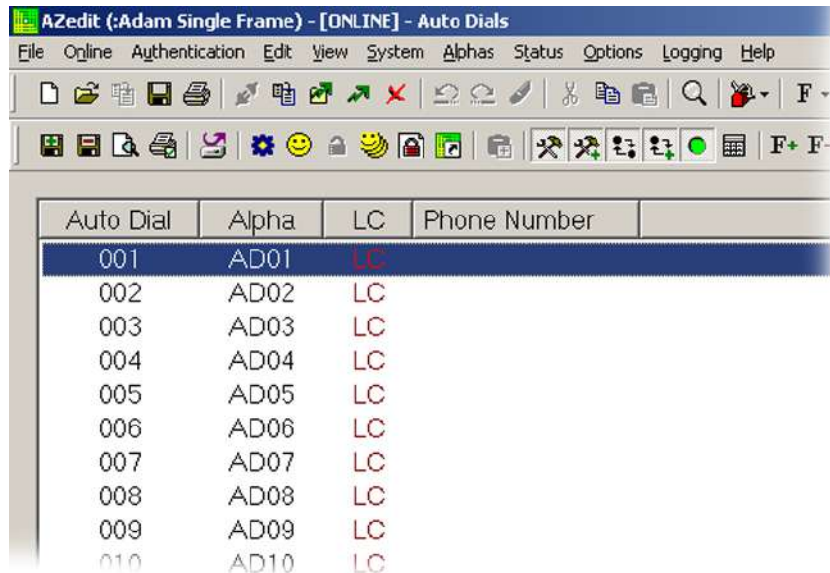

Auto Dial	Alpha	LC	Phone Number
001	AD01	LC	
002	AD02	LC	
003	AD03	LC	
004	AD04	LC	
005	AD05	LC	
006	AD06	LC	
007	AD07	LC	
008	AD08	LC	
009	AD09	LC	
010	AD10	LC	

To **add a telephone number to the Auto Dial database**, do the following:

1. From the System menu in AZedit, select **Auto Dial**.  
*The Auto Dial window appears.*
2. From the Auto Dial column, double-click an **auto dial number**.  
*The Edit Auto Dial window appears.*

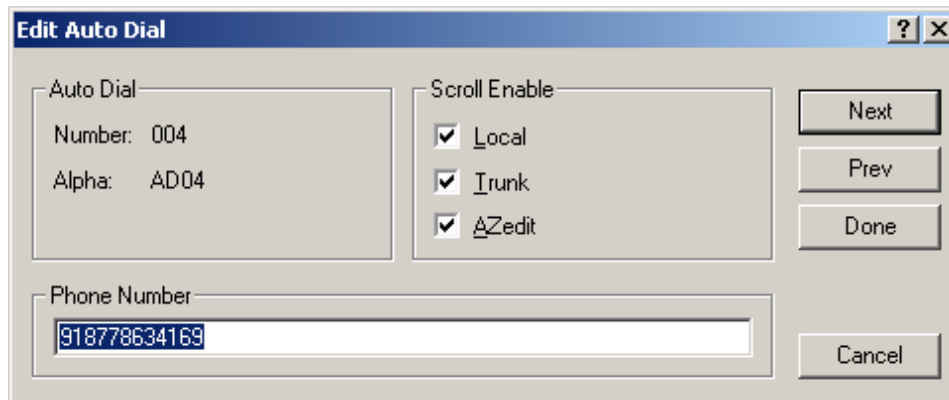

**Edit Auto Dial**

Auto Dial

Number: 004

Alpha: AD04

Scroll Enable

Local

Trunk

AZedit

Next

Prev

Done

Phone Number

918778634169

Cancel

3. From the Scroll Enable group box, select the **scroll enable check boxes** you want to configure for the auto dial number.
4. In the Phone Number field, enter the **telephone number** you want to have for that auto dial sequence.

**NOTE:** Entering \*99 creates a pause in dialing. This is used to dial extensions or select preset options.



5. Click **Next** to enter another number.  
*The next blank Edit Auto Dials window appears.*  
 OR  
 Click **Done** to close the Edit Auto Dial window.  
*The Auto Dials window appears with the new number in the list.*

To **add a description to the telephone number you added to the Auto Dial database**, do the following:

1. From the Alphas menu in AZedit, select **Auto Dial**.  
*The Auto Dial Alphas window appears.*
2. Double-click the **AD resource number** to which you want to add the description.  
*The Edit Alpha/Description window appears.*

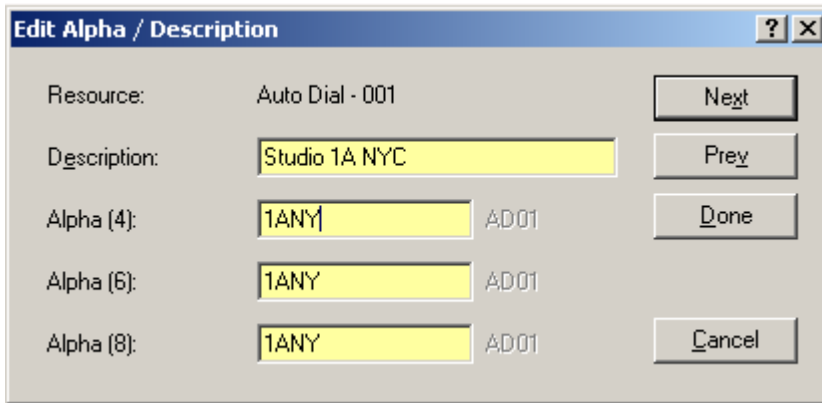

3. In the Description field, enter a **unique description** for the auto dial number. For example, Studio 1A NYC.
4. In the Alpha 4, Alpha 6, or Alpha 8 field, enter a **recognizable 4-, 6- or 8-character Alpha**. For example, 1ANY.
5. Click **Done** when you are finished.  
 OR  
 Click **Next** to enter another Alpha Description.

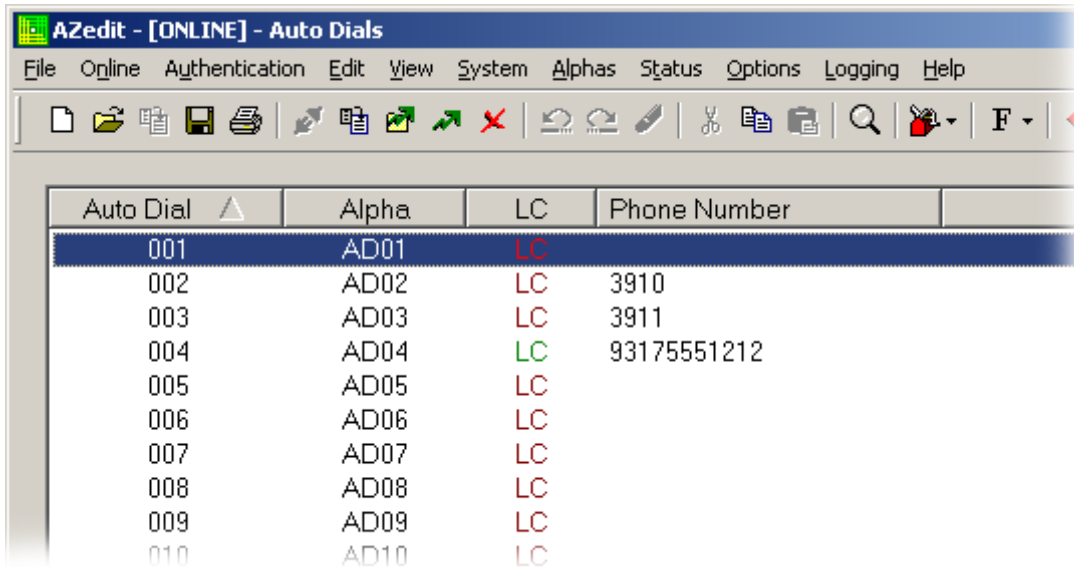

6. From the Online menu in AZedit, select **Send Changes**.  
*The Send Changes window appears.*
7. Click **OK**.  
*The changes are sent to the intercom and the telephone number is added to the intercom system auto dial table.*

To **use centralized auto dial numbers**, do the following:

1. On the keypanel, press the **TIF assignment key**.  
*Hang Up, Icom ADial, and Redial appear in the panel display.*
2. Using the AUX/MENU shaft encoder, scroll to **Icom ADial**.
3. Press the **SEL button**.  
*You enter the centralized auto dial list. A scrollable list of available Auto Dial numbers appear in the panel display.*
4. Using the AUX/MENU shaft encoder, scroll to the desired **auto dial number**.
5. Press the **SEL button**.  
*The number connects.*

---

## Receiving A Phone Call

When there is an incoming telephone call, the TIF alpha begins to tally.

To **receive a phone call**, do the following:

- > Press the **key** to answer the call.

**NOTE:** TIF assignments tally when the phone is ringing. By default, the assignments also tally while the phone is off-hook. This operation can be disabled by selecting the *Don't generate tallies for off-hook TIF assignments* check box in AZedit (Options|Intercom Configuration|Options page) or by editing the Enhanced Tally definitions for the TIF Off-hook and TIF ringing tally types.

---

## Hanging Up

### Keypanel Hang Up

To **hang up the telephone**, do the following:

1. On the keypanel, press the **TIF key** down to turn it on.  
*Icom ADial, Hang Up, and Redial appear in the panel display.*
2. Using the AUX/MENU shaft encoder, select **Hang Up**.
3. Press the **SEL button**.  
*The call is disconnected.*

To **redial a phone number**, do the following:

1. On the keypanel, press the **TIF listen key** on.
2. On the keypanel, press the **TIF talk key** on.  
*Icom ADial, Hang Up, and Redial appear in the panel display.*
3. Using the AUX/MENU shaft encoder, select **Redial**.
4. Press the **SEL button**.  
*The last dialed number is connected. The TIF key alpha flashes and Hang Up appears in the panel display.*
5. Press the **SEL button** to disconnect the call.  
*The call is ended.*

# Keypanel Menu Quick Reference

## Audio Options

Advanced			
AGC			
Attack			
	Hdst Mic Panel Mic	Fast Attack Speed	0.5ms 1ms (default) 2ms
Decay			
	Hdst Mic Panel Mic	Decay	500ms (default) 750ms 1000ms
Compression			
	Hdst Mic Panel Mic	Compression Ratio:	1:1 2:1 3:1 (default)
Filters			
Bandpass			
Inputs (KP-3016 Only)			
OMNEO 1 - Only when KP-3016 is used and has an AIO connection. OMNEO 2 - KP-3016 only			
Frequencies			
	Low Freq		0 Hz (default) 15.6Hz 31.5Hz 50Hz
	High Freq		22kHz (default) 16kHz 8KHz 4KHz
Mode			
Disabled (default)			
Enabled			

Outputs			
Headset	Both		
	Left Chan Right Chan		
Frequencies			
Low Freq			
			0 Hz (default) 15.6Hz 31.5Hz 50Hz
High Freq			
			22kHz (default) 16kHz 8kHz 4kHz
Mode			
			Disabled (default) Enabled
Matrix Out			
OMNEO 1 - Only when KP-3016 is used and has an AIO connection. OMNEO 2 - KP-3016 only			
Frequencies			
Low Freq			
			0 Hz (default) 15.6Hz 31.5Hz 50Hz
High Freq			
			22kHz (default) 16kHz 8kHz 4kHz
Mode			
			Disabled (default) Enabled
Equalization			
Inputs			
Hdst Mic Matrix In Panel Mic	Modes	Disabled (default) Enabled	
	Presets	Default (default) Hiss Reduction Rumble Reduction	
Outputs			
Speaker	Modes	Disabled (default) Enabled	
	Presets	Default (default) Hiss Reduction Rumble Reduction	
Notch			
Notch Filter			
			Disabled (default) Narrow Default Wide

<b>Gating</b>		
Hdst Mic Matrix In OMNEO 1 - Only when KP-3016 is used and has an AIO connection. OMNEO 2 - KP-3016 only Panel Mic		
Threshold		Disabled (default) -17dB – 18dB
<b>Metering</b>		
Hdst Mic Matrix In None (default) OMNEO 1 - Only when KP-3016 is used and has an AIO connection. OMNEO 2 - KP-3016 only Panel Mic		
<b>Mixing</b>		
Headset	Both Left Chan Right Chan	Hdst Mic OMNEO 1 - Only when KP-3016 is used and has an AIO connection. OMNEO 2 - KP-3016 only Panel Mic
OMNEO 1 - Only when KP-3016 is used and has an AIO connection. OMNEO 2 - KP-3016 only Speaker	Hdst Mic Matrix In OMNEO 1 - Only when KP-3016 is used and has an AIO connection. OMNEO 2 - KP-3016 only Panel Mic	
To Matrix	Matrix In OMNEO 1 - Only when KP-3016 is used and has an AIO connection. OMNEO 2 - KP-3016 only	
<b>Mix Mode</b>		
Mixes to Spkr/Hdst Switched (default)		
Mixes Always Active		
<b>Noise Gate</b>		
Hdst Mic Panel Mic	Disabled (default) Enabled	
<b>Chime</b>		
<b>Preview</b>		
Yes (default) No		
<b>Chime</b>		
System #1-12		
<b>Volume</b>		
-20dB (default) -60dB – 10dB		
<b>Dim</b>		
<b>Headset</b>		
	Dim Amount:	0dB (default) -32dB – 0dB

Speaker			
	Dim Amount:	-8dB (default) -48dB – 0dB Mute	
Headset Mic			
	Auto-Mute	Disabled Enabled (default)	
	Mode	Disabled Enabled Switched (default)	
	Type	Auto-Detect (default) Dynamic Electret	
Headset Spkr			
	Auto-Transfer	Disabled Enabled (default)	
	Mode	Both, Left Chan Right Chan	Always On (default) Disabled Switched
Inputs			
Matrix In			
	Disabled Enabled (default)		
OMNEO 1 - Only when KP-3016 is used and has an AIO connection.			
	Disabled Enabled (default)		
OMNEO 2 - KP-3016 only			
	Disabled Enabled (default) Ganged		
Key Volumes			
Adjust			
	Disabled Enabled (default)		
Minimum			
	Adjust Minimum Key Volumes		
Reset			
	Cancel Do Reset		
	Volumes Reset		
Matrix Out			
	Hot Mic Normal (default)		
Max Volume			
	Headset Speaker	Max Volume: -48dB – 10dB (default), Mute	

<b>Mic Gain</b>	
Hdst Mic	
Panel Mic	
	Mic Gain: 0dB (default) -20dB – 10dB
<b>Mic Mute</b>	
	Disabled
	Momentary
	Toggle (default)
<b>Min Volume</b>	
Headset	
Speaker	
Matrix In	
OMNEO 1 - Only when KP-3016 is used and has an AIO connection.	Min Volume: Mute (default) -48dB – 10dB
OMNEO 2 - KP-3016 only	
<b>Output Level</b>	
Output Level:	8dB (default) – 0dB
<b>Panel Mic</b>	
	Disabled
	Enabled
	Switched (default)
<b>Sidetone</b>	
Level	
	Sidetone Level: -20dB (default), -65dB to 0dB
Mode	
	Always On
	Disabled
	Switched (default)
<b>Speaker</b>	
	Always On
	Disabled
	Switched (default)
<b>Tone Gen</b>	
Frequency	1KHz Tone 500Hz Tone (default)
	Tone Off (default)
	Tone On

## Display Menu

Assign Type	Shows key's assignment types
Chans On	Shows scroll list of current callers
Chime	Shows keys with Chime assigned
Exclusive	Shows which keys are Exclusive keys
Key Groups	Group 1 - shows which key is Master, and which keys are Group Slaves Group 2 - shows which key is Master, and which keys are Group Slaves Group 3 - shows which key is Master, and which keys are Group Slaves Group 4 - shows which key is Master, and which keys are Group Slaves
Key List	Shows scroll list of hidden key assignments assigned to virtual keys
Level 2	Level 2 Assignments - Shows the talk level 2 assignment for each key assignment
Listen	Listen Assignments - Shows the listen assignment for each key assignment
Matrix	Key Assignment Matrices - Shows the matrix for each key assignment
Panel ID	<Panel ID> - Shows the port number and alpha for this keypanel
Solo Key	Solo Key - Shows which key is the solo key
Version	Version X.X.X - shows the keypanel firmware version



*Key Assign Menu*

Matrix (only displays if there are remote matrices. Selecting Matrix displays a list of remote intercoms.)	<Ports/Assignments>	Listen Talk Lvl1 Talk Lvl2 Talk+AF Talk+AL Talk+AM Talk+AR Talk+AT	Tap Key
Pt-to-Pt			
Party Line			
IFB			
Special List			
Sys Relay			
Camera ISO			
UPL Resource			
IFB Spcl List			
Auto Funcs			

*Key Options Menu*

Chime	
Chime	<none> System #1 System #2 System #3 System #4 System #5 System #6 System #7 System #8 System #9 System #10 System #11 System #12
Duration	
	One-shot (default) 1 second 2 seconds 3 seconds 4 seconds 5 seconds 10 seconds 15 seconds 20 seconds 30 seconds 60 seconds 90 seconds 2 minutes 3 minutes 4 minutes 5 minutes
Clear	
	Tap Key
Exclusive	
	Tap Key
Icons	
Icon	Key has TIF Asgn Key is Solo Key Key is Exclusive Key Key has Auto-Dial Key is Group Master Key has Chime Key has Trunk Asgn
Display	
	Disabled Enabled (default)

Key Groups		
Group 1	Tap Master Key	Tap Slave Key
Group 2		
Group 3		
Group 4		
Latching		
Global		
Disabled		
Enabled (default)		
Per Key		
Tap Key		
Lock		
Tap Key		
Solo		
Tap Key		
Tallies		
Indefinite		
Disabled (default)		
Enabled		
Min Duration		
Min Duration:		
5 seconds		
10 seconds		
15 seconds (default)		
Turn Off		
All Keys		
Turn Keys Off?		
Keys Turned Off		
Talk Keys		
Turn Keys Off?		
Keys Turned Off		
Listen Keys		
Turn Keys Off?		
Keys Turned Off		

---

### *OMNEO Offers Menu (KP-3016 Only)*

Keypanel	
OKP	
	<Port #> - Shows currently selected connection offer, alternative offers, or <none>
AIO - If an RVON-IO or an OEI-2 is connected, it shows that device instead	
	Disabled
	Enabled (default)
Aux Input	
OMNEO 1 - Only when KP-3016 is used and has an AIO connection.	
	<Port #> - shows currently selected connection offer, or <none>
OMNEO 2	
	<Port #> - shows currently selected connection offer, or <none>

---

### *Save Config Menu*

Configuration Saved
---------------------

*Service Menu*

Alphas			
	4 Chars (default)		
	6 Chars		
	8 Chars		
	8 Chars (Unicode)		
Display			
Menu Context			
	Disabled		
	Enabled (default)		
Show Volume			
	Disabled (default)		
	Enabled		
KP32 Emulation			
	Disabled (default)		
	Enabled		
Intercom Mode			
Alternate			
	Standard (default)		
Key View			
Show Gain			
	Disabled (default)		
	Enabled		
Show Lstn			
	Disabled (default)		
	Enabled		
	Enabled (Suppress Auto)		
Show Mtx			
	Disabled (default)		
	Enabled		
	Enabled (Suppress Local)		
Keypad			
Backlight			
Activation			
	Activate		
		On Keypress (swallowed) (default)	
		On Keypress (processed)	
		Always	
		Never	
	Setup		
	Inactive		
		Brightness: ##% (default is 30%)	
		Color:	
		Blue (default)	
		White	
	Active		
		Brightness: ##% (default is 100%)	
		Color:	
		Blue (default)	
		White	

Shift State	
Brightness: ##% (default is 100%)	
Color:	
Blue	
White (default)	
SEL Key	
Auto (default)	
Assign Groups	
Quick Assign	
LCD Backlight	
All Panels	
Brightness:	
65% (default)	
35% – 100%	
Main Panel	
Both, Left, Right	
Brightness:	
65% (default)	
35% – 100%	
EKP	
Both, Left, Right	
Brightness:	
65% (default)	
35% – 100%	
OMNEO Setup (KP-3016 Only)	
OKP	
OEI-2 (if attached)	
Device Name	
<displays device name and allows editing>	
DHCP	
Disabled (default)	
Enabled	
IP Parameters	
IP Address <displays IP Address and allows editing>	
Netmask <displays Netmask and allows editing>	
Gateway <displays Gateway and allows editing>	
DNS Server 1 <displays DNS Server and allows editing>	
Domain <displays Domain Name and allows editing>	
Page Change	
Auto (default)	
Always Allow	
No Talk Keys	
Reset Cfg	
Cancel	
Do Reset	
Configuration Reset	
Scrn Saver	
Activate	
Delay	
Display Dim	
Delay Time:	1 hour (default) (30 min, 1 – 12 hours, and Disabled)
Activation	
Delay Time:	1 hour (default) (30 min, 1 – 12 hours, and Disabled)

Display Dim	
	Brightness: 25% (default) (0% – 100%)
Mode	
	Bitmap
	Bounce Scroll (default)
	Display Off
	Text (default)
	Bounce Scroll (default)
Set Address	
	Poll ID <1–8>
	Cancel
	Save and Restart
Snoop Tally	
	Chime:
	none (default), System #1, System #2, System #3, System #4
	Duration:
	One-shot (default) (1 sec, 2 sec, 3 sec, 4 sec, 5 sec, 10 sec, 15 sec, 20 sec, 30 sec, 60 sec, 90 sec, 2 min, 3 min, 4 min, 5 min)
Test Panel	





# *Unicode Support*

---

## *AZedit and Unicode Support*

Minimum firmware revision requirements for Unicode support are:

- MCII-e v2.4.0 or later
- AIO-8 v10.5.0 or later
- AIO-16 v1.3.0 or later
- Cronus v1.8.0 or later
- Zeus III v1.3.0
- KP 32 CLD v1.3.0 or later
- KP 12 CLD v1.1.0
- RP-1000 v2.0.0
- KP12/4U v1A.0.26 (Cyrillic character set only)
- KP-4016/5032 v1.0.2
- KP-3016/3016A v1.1.0

To **configure the keypanel for Unicode operation**, do the following:

**IMPORTANT:** Before going further, save the setup file. This is needed to restore system configuration after enabling Unicode operation.

1. On the keypanel, select **Service|Alphas|8 Chars (Unicode)|Save and Restart**.

**NOTE:** If using the keypanel with Japanese firmware, you must also configure the correct Intercom Mode. See “Service Menu, Intercom Mode” on page 123.

2. From the Options menu in AZedit, select **Preferences**.  
*The Application Preferences window appears.*
3. Select the **Advanced** tab.  
*The Advanced page appears.*
4. Select the **Allow intercom resizing in ONLINE mode** check box.

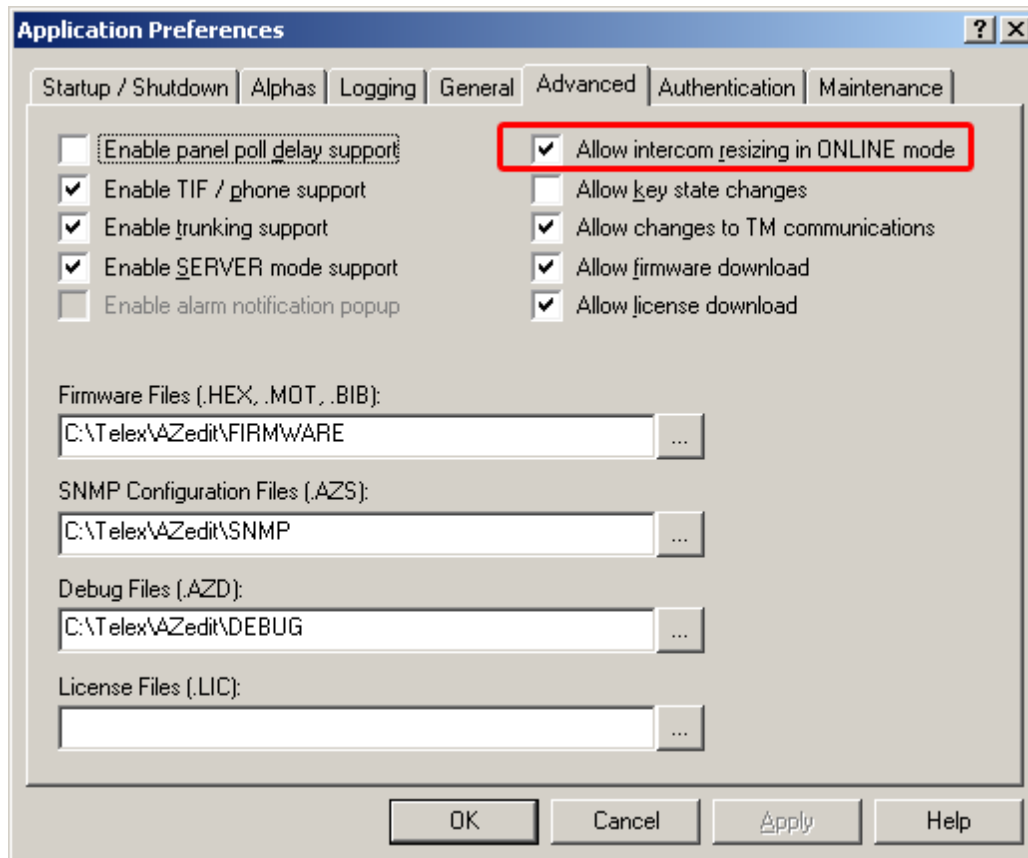

5. Click **Apply**.
6. Click **OK**.  
*The Application Preferences window closes.*

**IMPORTANT:** **You are about to erase the entire intercom setup! Be sure to save your file.**

7. From the Options menu, select **Intercom Configuration**.  
*The Intercom Configuration window appears.*

8. Click the **Options** tab.  
*The Options page appears.*
9. Select the **Enable Unicode Alphas** check box.

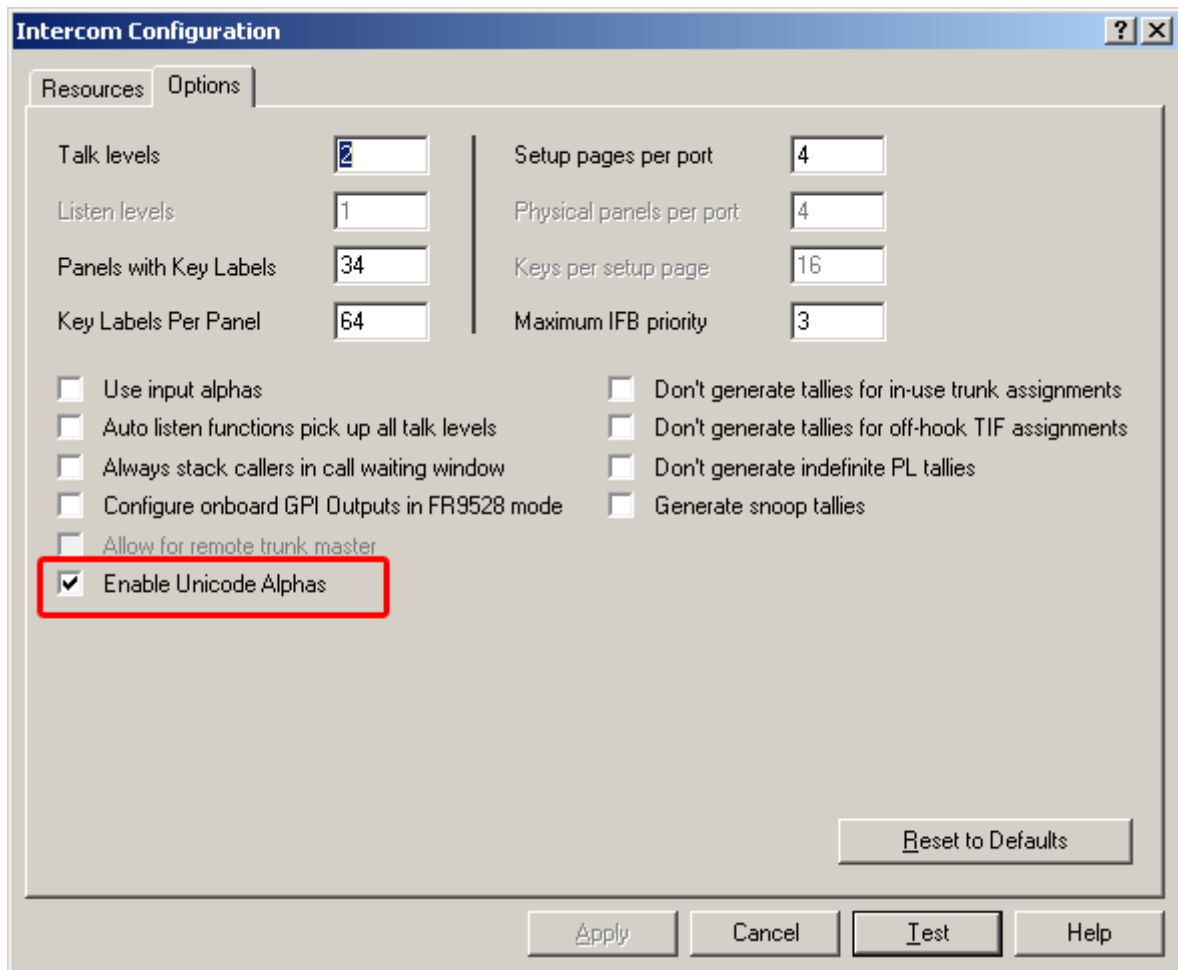

10. Click **Apply**.  
*The Intercom Configuration window closes.*
11. From the Options menu, select **Preferences**.  
*The Application Preferences window appears.*
12. Click the **Alphas** tab.  
*The Alphas window appears.*

- From the Preferred alpha size drop down menu, select **8-UNICODE characters**.

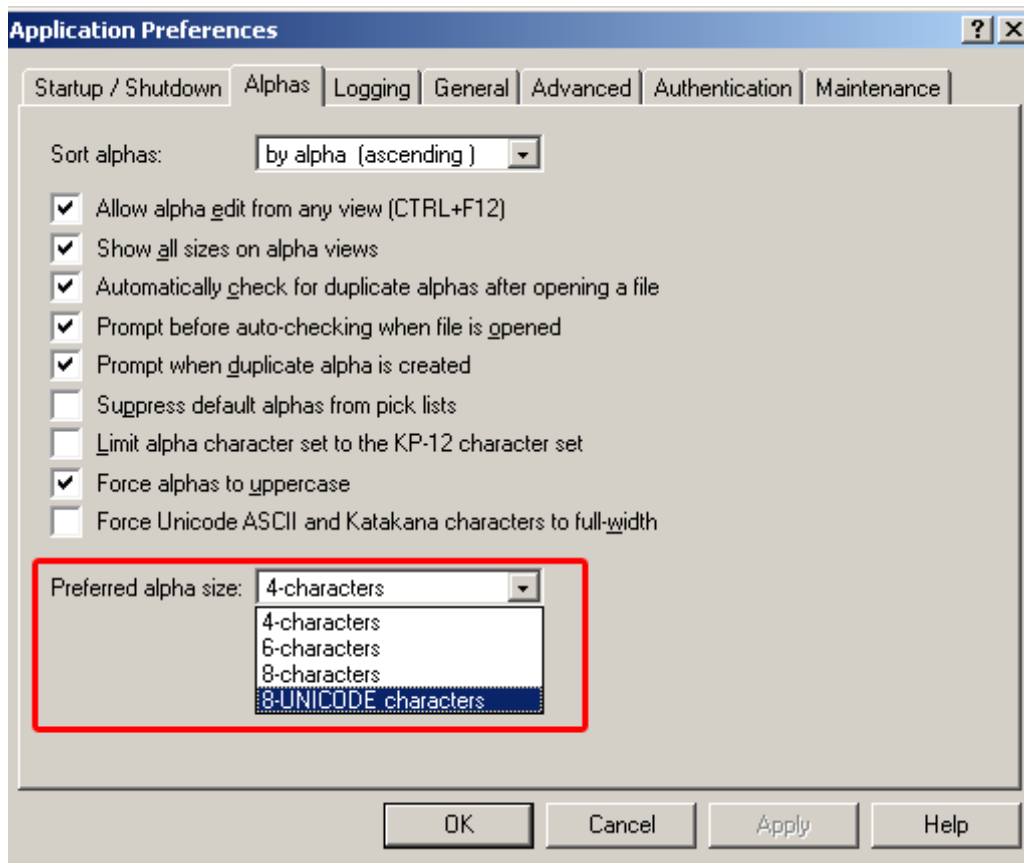

- Click **Apply**.
- Click **OK**.  
*The Application Preference window closes.*

To **restore the system configuration**, do the following:

- From the Online menu, select **Send File**.
- Navigate to the **system configuration file (.adm)** you want to restore.
- Click **OK**.

## *Power Supply Mounting*

---

**IMPORTANT:** The KP-3016/3016A can only be mounted directly into a rack and cannot have the power supply mounted to the unit. However, the power supply can be mounted to the EKP-3016. For more information, see “Mounting the Power Supply to the EKP-3016” on page 163.

---

---

### *Mounting the Power Supply to a Standard Rack*

The **Power Supply Mounting** bracket can be directly attached to a standard rack, horizontally or vertically as shown in Figure 23 and Figure 24.

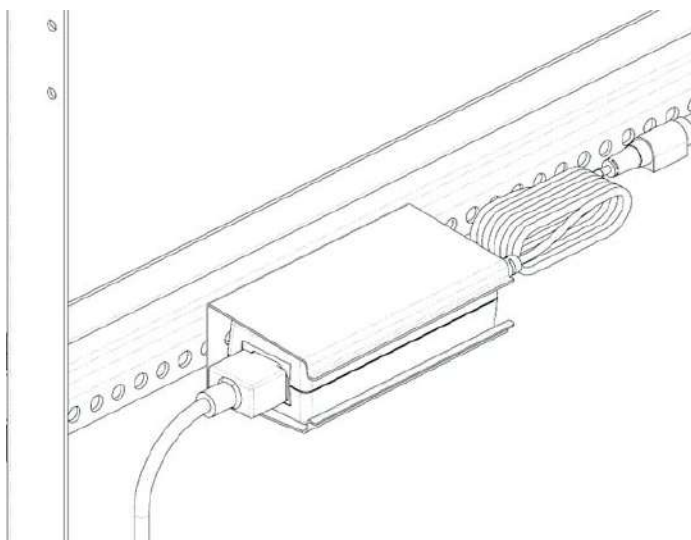

**FIGURE 23.** Mounting Bracket – Horizontal on a Crossbar

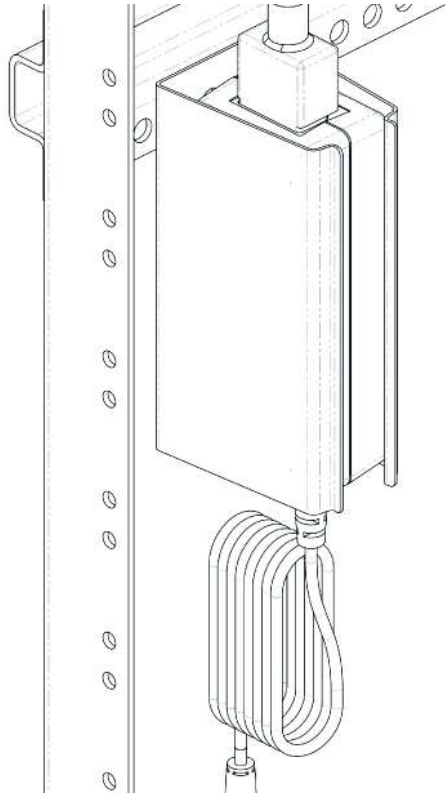

**FIGURE 24.** Mounting Bracket – Vertical from a Crossbar

# *EKP-3016*

---

## *Introduction*

Connecting directly to the KP-3016/3016A color keypad, the EKP-3016 (Expansion Panel) provides an additional 16 keys to your keypad.

---

**IMPORTANT:** The EKP-3016 is not compatible with the KP-5032 or KP-4016 keypanels.

---

---

## *Specifications*

### LCD Display

#### Active Area

120.10mm (wide) x 18.77mm (high)

#### Dot Resolution

576 x 90 dots

#### Color Resolution

16-bit (64K) RGB color

#### View

#### Angle

80 degrees (typical; all directions)

### Connector

EXP IN                      RJ-45

### General

#### EKP-3016

#### Storage Temperature

-40°C to 70°C (-40°F to 158°F)

#### Operating Temperature

0°C to 55°C (32°F to 131°F)

#### Dimensions

17.39”L x 1.72”H x 3.92”D (441.82mm x 43.8mm x 99.5mm)

#### Weight

2.95b (1.34kg)

#### Power Consumption

##### Nominal

6 Watts

##### Maximum

7 Watts  
Maximum Volt Amp  
48 VA  
Input Power  
100~240VAC, 50~60Hz



*EKP-3016 Expansion Panel Reference View*

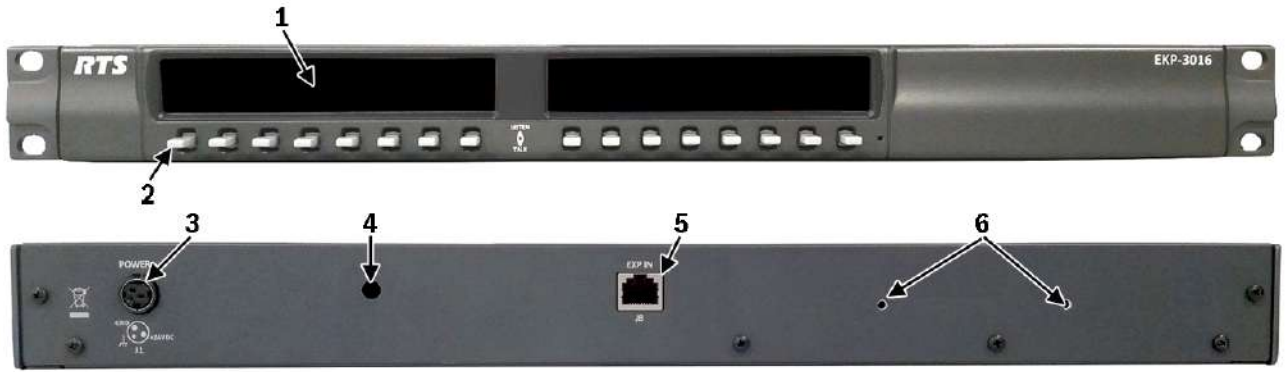

**FIGURE 25.** EKP-3016 Expansion Panel Reference View - Front and Rear

1. Expansion Keys
2. AC/Power
3. Power Supply Bracket Mounting Holes
4. RJ-45 Expansion IN
5. Power Supply Cable Tie Mounting Hole

*Expansion Panel Cabling Reference*

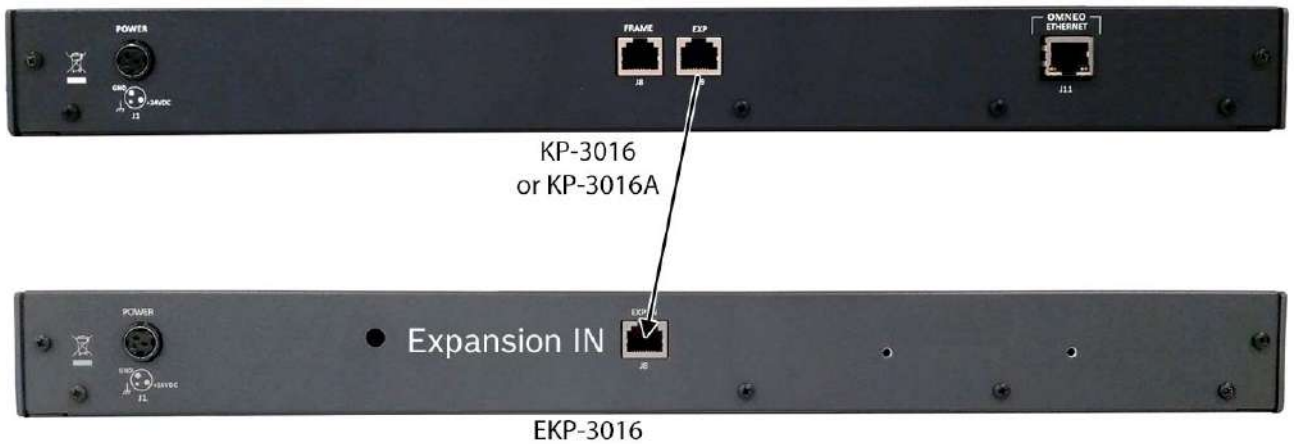

**FIGURE 26.** Expansion Panel Cabling

RJ-45 EXP IN (expansion)			
Pin	Assignment	Pin	Assignment
1	NC	5	NC
2	NC	6	NC
3	NC	7	RS485 +
4	NC	8	RS485 -

## Mounting the Power Supply to the EKP-3016

To mount the power supply mounting bracket to an EKP-3016, do the following:

1. Align the **power supply mounting bracket** screw holes with the appropriate mounting holes on the rear panel of the EKP-3016 unit.
2. Using a screwdriver, attach the **power supply mounting bracket** with the two (2) supplied screws.

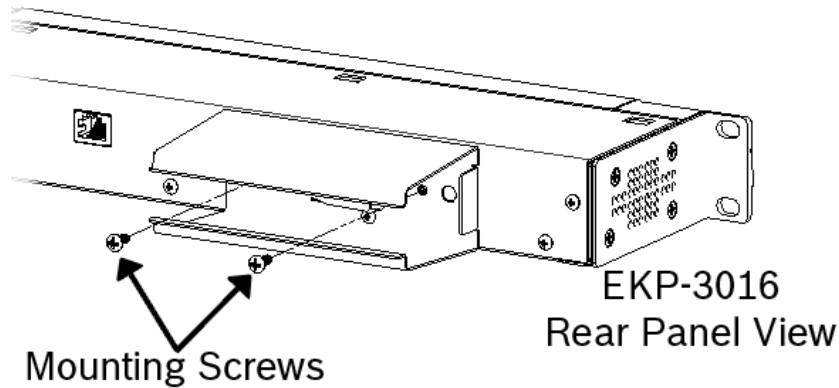

3. Attach the **power supply cable tie clip** to the predefined clip mounting hole on the rear of the keypanel unit.
4. From the left-hand side of the mounting bracket, carefully slide the **power supply** into the bracket.

**NOTE:** The Frame and EXP OUT connections cannot be populated until the power supply mounting bracket is fully installed.

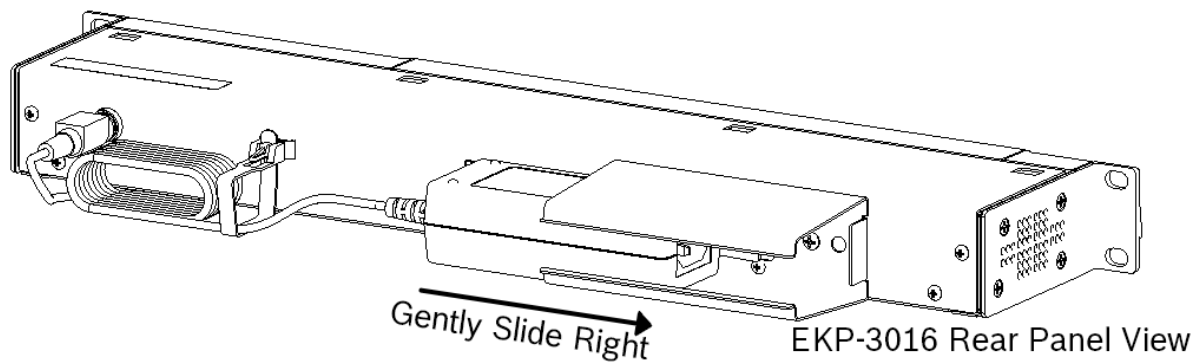

5. Attach the **DC power connector** to the unit.

6. Carefully coil the **power supply cord** and insert it into the cord clip.

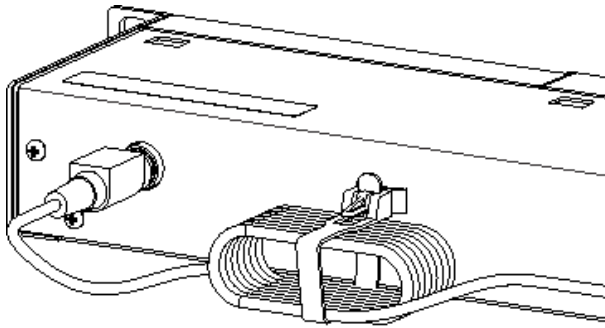

### EKP-3016 Rear Panel View

7. Attach the **AC power connector** to the power outlet on the power supply.

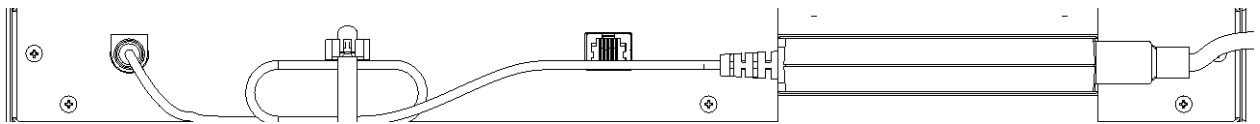

8. Plug the **power cord** into an electrical outlet.

---

*Notes*

---

**Bosch Security Systems, Inc.**

12000 Portland Avenue South

Burnsville, MN 55337 U.S.A.

[www.boschcommunications.com](http://www.boschcommunications.com)