

EK 6042

Instruction manual

Contents

The EK 6042 portable camera receiver	5
Package contents	5
Product overviews	6
Top	6
Functions of the buttons	7
Front	7
Bottom	8
LED indicators	8
Display panel	9
Backpanel adapter	11
Putting the EK 6042 into operating	12
Mounting the EK 6042 into a video camera	12
Connecting the backpanel adapter	13
Connecting the accupack adapter	13
Connecting the EK 6042 to a sound recording device or a mixing console	14
Connecting headphones	14
Using the EK 6042	15
Switching the EK 6042 on or off	15
Calling up the standard display, the CH1 display or the CH2 display	15
Using the operating menu	15
Performing a synchronization (Sync)	17
Performing an automatic configuration (Auto)	18
Performing a frequency scan	19
Changing scenes	19
Configuring the EK 6042 using a web browser	20
Care and maintenance	22
Accessories	22
Specifications	23
Licenses	1
eCos	1
Display Font (Palm OS)	1
DHCP Server (dhcps)	1
The Creative Commons License	2
Pin assignment	1

The EK 6042 portable camera receiver

The EK 6042 is a miniature two-channel true diversity receiver. It can be inserted into the receiver slot of professional video cameras or portable mixing consoles with UniSlot/SuperSlot™ interface (e.g. Panasonic, Ikegami, ARRI, Sound Devices) or Sony interface. Together with a high-performance Sennheiser bodypack, plug-on or handheld transmitter, a highly reliable radio link can be set up.

The EK 6042 has the following features:

- Simultaneous reception from two transmitters
- Compatibility with almost all Sennheiser transmitters and microphones such as e.g.
 - digital transmitters of the Digital 9000 series that are operated in LR mode
 - analog transmitters of the 5000, 3000 and 2000 series that are operated in FM mode and feature the HDX or HiDyn plus companders
- Choice of analog or digital audio output
- Great ease-of-use due to
 - quick and easy One Touch Easy Setup
 - menu-assisted operation via display panel
 - configuration possibility via web browser
- Adapters for professional video cameras with UniSlot/SuperSlot™ interface (e.g. Panasonic, Ikegami, ARRI, Sound Devices) and Sony interface
- Power supply either via the video camera, an external power supply or the Sennheiser GA 6042 BA accupack adapter
- High operational reliability due to true diversity reception
- Wide range of accessories to suit every application (see “Accessories” on page 22)

Package contents

- 1 EK 6042 camera receiver
- 2 antennas
- 1 USB cable
- 1 transport case
- 1 instruction manual

Information on accessories (e.g. power supply, cables and adapters) can be found on page 22.





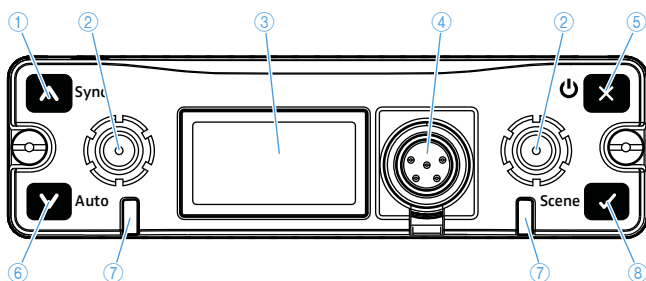



Product overviews

Top



- | | |
|--|--|
| <p>① Button </p> | <p>Short-press: Navigates up in the menu or returns you to the standard display</p> <p>Long-press: See "Performing a synchronization (Sync)" on page 17</p> |
| <p>② SMA sockets</p> | <p>for the detachable antennas (diversity section A and B)</p> |
| <p>③ Display panel</p> | <p>For details, see page 9</p> |
| <p>④ 5-pin mini XLR socket (Top) AUX 1/2</p> | <p>Audio socket of the secondary audio outputs AUX 1 and AUX 2 (underneath a cover) can only output analog audio signals outputs the same audio signal as the audio socket AUX 1/2</p> |
| <p>⑤ Button </p> | <p>Short-press: Exits the menu item</p> <p>Long-press: See "Switching the EK 6042 on or off" on page 15</p> |
| <p>⑥ Button </p> | <p>Short-press: Navigates down in the menu or returns you to the standard display</p> <p>Long-press: See "Performing a synchronization (Sync)" on page 17</p> |
| <p>⑦ LED CH1 and CH2</p> | <p>Status LEDs for receiving channel CH1 or CH2</p> <p>For details, see page 8</p> |
| <p>⑧ Button </p> | <p>Short-press: Confirms the selection</p> <p>Long-press: See "Changing scenes" on page 19</p> |

Functions of the buttons

Button	Function
 Short-press:	<ul style="list-style-type: none"> • Navigates to the next higher level in the menu • Exits the menu item without storing changes to the settings
 Long-press:	<ul style="list-style-type: none"> • Switches the EK 6042 on (see page 15) • Switches the EK 6042 off
 Short-press:	<ul style="list-style-type: none"> • Changes from the current standard display, the CH1 display or the CH2 display to the operating menu • Calls up the selected menu item
 (Scene) Long-press:	<ul style="list-style-type: none"> • Calls up a stored scene (see page 20)
 Short-press:	<ul style="list-style-type: none"> • Switches between the standard display, the CH1 display and the CH2 display • Returns you to the previous menu item • Increases the set value
 (Sync) Long-press:	<ul style="list-style-type: none"> • Synchronizes a transmitter with the EK 6042 (see page 17)
 Short-press:	<ul style="list-style-type: none"> • Switches between the standard display, the CH1 display and the CH2 display • Changes to the next menu item • Reduces the set value
 (Auto) Long-press:	<ul style="list-style-type: none"> • Starts the automatic configuration (see page 17)

Front

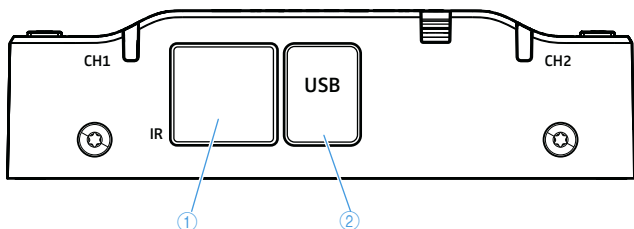

- ① Infra-red interface for synchronization with transmitters (see [Sync](#) on page 17 and [Auto](#) on page 18)
- ② USB port for connecting a computer for configuration via a web browser (see page 20)

Bottom

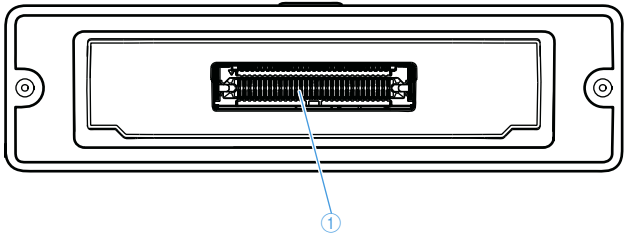

- ① Multi-pin interface for connecting accessories

LED indicators

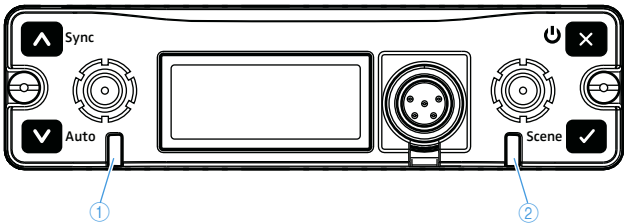

- ① LED CH1 Status LED for receiving channel CH1
- ② LED CH2 Status LED for receiving channel CH2

LED	Meaning
off	The receiving channel is deactivated, e.g. to save battery life. "Inactive" appears on the display panel. For how to activate/deactivate a receiving channel, refer to " Channel Power " on page 16.
green	The receiving channel is activated and receives a transmitter. The accupacks of the transmitter and the receiver are sufficiently charged.
yellow	A status message is shown on the display panel.
red	The receiving channel does not receive a transmitter.

Display panel

The display panel provides various status information and displays the operating menu. For how to call up the following displays, refer to page 15. For information on the operating menu, refer to page 15.

Standard display

The standard display is shown after switch-on.

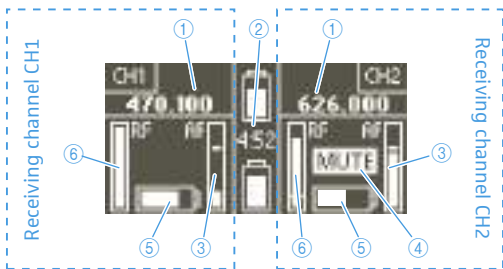

① Receiving frequency

② Source and status of the power supply:



If the GA 6042 BA accupack adapter is used, the charge status and the remaining operating time of the inserted BA 61 accupacks is displayed.



If an external power supply is connected, a plug icon is displayed.



If the EK 6042 is inserted into the receiver slot of a video camera, a video camera icon is displayed.



If the EK 6042 is inserted into a SuperSlot™-compatible receiver slot, the logo shown on the left is displayed.

③ Audio level of the transmitter with peak hold function

④ Mute display: Either the EK 6042 has muted the audio output due to too weak or noisy signal or the received transmitter has been muted via its MUTE switch.

⑤ Battery charge status of the received transmitter

⑥ Signal strength of the received signal on the receiving channel

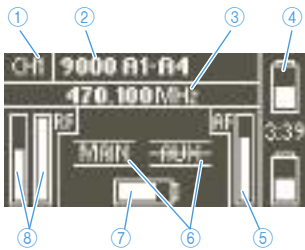

CH1 and CH2 display

Digital reception

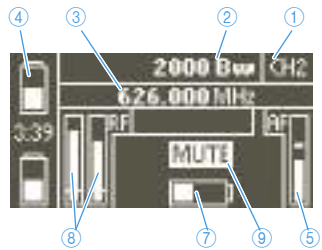

Analog reception



- ① Receiving channel
- ② Name of the received transmitter
- ③ Receiving frequency
- ④ Source and status of the power supply (see also ② on page 9)
- ⑤ Audio level of the transmitter (deviation/modulation) with peak hold function
- ⑥ Audio output display
 -  If an audio output is active, its icon appears as shown on the left.
 -  If an audio output is muted via the command function, its icon is crossed out.
 - inactive** If the receiving channel has been deactivated via the **Channel Power** menu, "inactive" is displayed.
- ⑦ Battery charge status of the received transmitter
- ⑧ Signal strength of the received signal of both diversity sections with display of the squelch threshold
- ⑨ Mute display (see also ④ on page 9)

Backpanel adapter

The GA 6042 BP backpanel adapter is available as an accessory. The backpanel adapter is required if you want to use the EK 6042 remotely from the video camera.

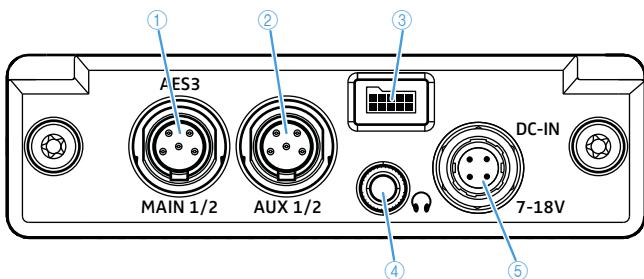

- | | |
|--|--|
| ① 5-pin mini XLR socket
AES3 MAIN 1/2 | Audio socket of the primary audio outputs can output analog or digital audio signal |
| ② 5-pin mini XLR socket
AUX 1/2 | Audio socket of the secondary audio outputs AUX 1 and AUX 2 can only output analog audio signals outputs the same audio signal as the audio socket (Top) AUX 1/2 |
| ③ Socket for accupack | for connecting the GA 6042 BA accupack adapter |
| ④ 3,5 mm jack socket
PHONES | for connecting a pair of headphones |
| ⑤ DC-IN socket | for connecting an external power supply |

Putting the EK 6042 into operating

Mounting the EK 6042 into a video camera

You can mount the EK 6042 into the receiver slot of a video camera. In order to mount the EK 6042 into video cameras with UniSlot/SuperSlot™ interface (e.g. Panasonic, Ikegami, ARRI, Sound Devices), you require the GA 6042-25 mounting kit. In order to mount the receiver into Sony video cameras, you require the GA 6042-15 mounting kit. Each mounting kit consists of an adapter plate (4) and a D-sub adapter (5).

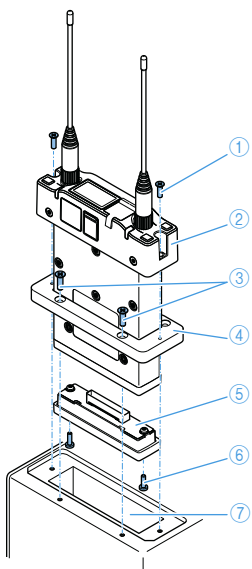

- ▶ Secure the adapter plate onto the receiver slot (7) of your video camera using the four supplied screws (3).
- ▶ Carefully connect the D-sub adapter to the multi-pin interface of the EK 6042 (2). Secure the D-sub adapter to the EK 6042 using the two supplied screws (6).
- ▶ Slide the EK 6042 with the mounted D-sub adapter through the adapter plate into the receiver slot.
- ▶ Secure the EK 6042 to the video camera using the two supplied screws (1). The EK 6042 is connected via its multi-pin interface to the video camera and is powered via the video camera's rechargeable battery.



If you use the EK 6042 in the receiver slot of a video camera with UniSlot/SuperSlot™ interface (e.g. Panasonic, Ikegami, ARRI), the audio signals of both receiving channels are transmitted to the camera via the receiver's multi-pin interface.

If you use the EK 6042 in the receiver slot of a Sony video camera, it might be that the camera only accepts the audio signal of receiving channel CH1. If you also want to transmit receiving channel CH2 to the video camera:

- ▶ Use the Y-adaptor cable to connect the 5-pin mini XLR socket (Top) AUX 1/2 to a second audio input of your Sony video camera.

Connecting the backpanel adapter

In order to use the EK 6042 remotely from your video camera (e.g. on a portable mixing console), you require the GA 6042 BP backpanel adapter as well as an external power supply.

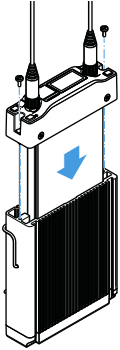

- ▶ Carefully slide the EK 6042 completely into the back-panel adapter.
- ▶ Secure the EK 6042 to the backpanel adapter using the two supplied screws.
- ▶ Use two Y-adaptor cables to connect the primary and – if desired – the secondary audio outputs to your mixing console (see page 14).
- ▶ Use the CA 6042 DC DC-IN cable to connect an external power supply to the **DC-IN** socket or mount the GA 6042 BA accupack adapter (see below).

i You can remove the belt clip of the backpanel adapter.

Connecting the accupack adapter

In order to power the EK 6042 with accupacks, you require the GA 6042 BA accupack adapter, two BA 61 accupacks and the L 60 charger:

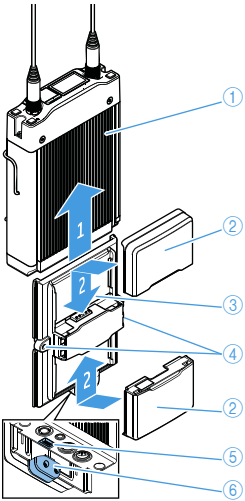

- ▶ Mount the backpanel adapter ① (see above).
- ▶ Slide the accupack adapter ③ to the correct side of the backpanel adapter so that the connector of the accupack adapter ⑥ connects to the socket for accupack ⑤.
- ▶ Secure the accupack adapter to the back-panel adapter using the two supplied screws ④.
- ▶ Slide the two BA 61 ② onto the accupack adapter until they lock into place with an audible click.

i You can replace one of the accupacks at any time, even during operation. If one accupack is replaced, the second accupack takes over the power supply.

Connecting the EK 6042 to a sound recording device or a mixing console

The EK 6042 can receive two transmitters simultaneously. In order to connect the EK 6042 to the sound recording device or the mixing console, you require at least one Y-adapter cable.

- ▶ Connect a Y-adapter cable to each of the desired audio outputs ([MAIN 1/2](#) and/or [AUX 1/2](#)).
- ▶ Set the desired audio format via the **MAIN Format** menu item: **digital AES-3** or **analog**.

The primary audio outputs [MAIN 1/2](#) can output the audio signals of both receiving channels either in analog form or digitally. The secondary audio outputs [AUX 1/2](#) and [\(Top\) AUX 1/2](#) can only output analog audio signals.

Connecting headphones

CAUTION

Hearing damage due to high volumes



The headphones connected to the headphone output are capable of producing high sound pressure levels. Higher volumes or longer durations can damage your hearing.

- ▶ Set the volume to a medium level.
 - ▶ Reduce the volume level before changing a transmitter or a frequency.
-

- ▶ Mount the backpanel adapter (see page 13).
- ▶ Connect the headphones to the 3.5 mm jack socket [PHONES](#) of the back-panel adapter.

Using the EK 6042

Switching the EK 6042 on or off

To switch the EK 6042 on:

- ▶ Long-press the **ⓧ** button.

The standard display appears. The volume of the headphone output is automatically adjusted to a low level.

To switch the EK 6042 off:

- ▶ If a submenu is open (see also page 16), press the **ⓧ** button repeatedly until the standard display, the CH1 display or the CH2 display is shown on the display panel.
- ▶ Long-press the **ⓧ** button.
An animation is shown. The EK 6042 then switches off.

Calling up the standard display, the CH1 display or the CH2 display

After switch-on, the standard display ① is shown on the display panel. To change to the CH1 display ② or to the CH2 display ③:

- ▶ Press the **⬆** button or the **⬇** button.

To change from the operating menu (see page 16) back to the standard display:

- ▶ Press the **ⓧ** button repeatedly until the standard display is shown.

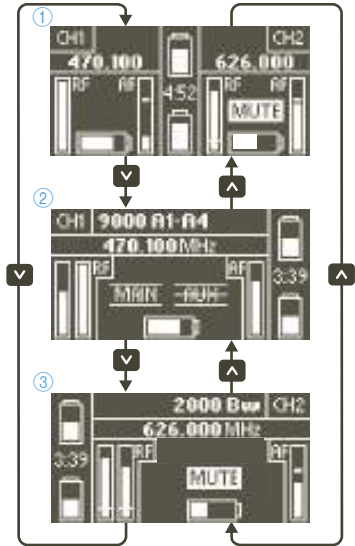

Using the operating menu

Calling up the operating menu

- ▶ Short-press the **⬇** button when the standard display, the CH1 display or the CH2 display is shown.

- If you call up the operating menu from the standard display, the **MAIN Format** menu item is displayed.
- If you call up the operating menu from the CH1 display, the **CH1 Settings** menu item is displayed.
- If you call up the operating menu from the CH2 display, the **CH2 Settings** menu item is displayed.

Overview of the operating menu

Main menu	Submenu	Possible settings
CH1 Settings CH2 Settings	Transmitter	Search via IR: Detects the transmitter via the infra-red interface
		List: Selects a transmitter from the list
	Frequency	Scan to next: Automatically searches a suitable frequency on the basis of the Squelch setting
		Tune: Manually sets the frequency
		License: Selects a frequency preset
	Sync	Transfers the frequency to the transmitter using the infra-red interface; see "Performing a synchronization (Sync)" on page 17
	Pilot Squelch	inactive: Pilot tone evaluation is deactivated
		active: Pilot tone evaluation is activated
		not supported: Transmitter does not support the pilot tone function
	Squelch	Analog reception: Adjusts the squelch threshold
		Digital reception: inactive
	MAIN Out AUX Out	always ON: Audio output is always activated
		ON by command: Audio output can be activated via the command function
		MUTE by command: Audio output can be muted via the command function
Channel Power	inactive: Audio signal is muted at all output sockets and only active at the headphone output	
	active: Audio signal is active at all output sockets	
MAIN Format		digital AES-3 or analog
Level MAIN 1		Digital reception: digital
Level MAIN 2		Analog reception: Adjusts the audio level



Main menu	Submenu	Possible settings
Level AUX 1		Adjusts the audio level
Level AUX 2		
Test tone		on or off
PHONES Volume		Adjusts the headphone volume
PHONES Listen to		Routes the signal of the receiving channel CH1 or CH2 or CH1+CH2 to the headphone output
Store Scene		Stores the current settings as a scene
Network		Changes the IP address of the receiver
Info		Displays the firmware version and the word clock status
Licence List		Displays licensed frequencies
Spectrum Scan		Performs a frequency scan

Performing a synchronization (Sync)

Suitable settings for the transmitter must have been made in the **Transmitter**, **Frequency** and **Squelch** submenus in the **CH1 Settings** or **CH2 Settings** menu.

There are two options to start a synchronization.

Option one:

- ▶ Long-press the  button.
The receiving channel selection appears.
- ▶ Select the receiving channel (**CH1** or **CH2**) with which the transmitter is to be synchronized and press the  button to start the synchronization.



Option two:

- ▶ Call up the **Sync** submenu (in the **CH1 Settings** or **CH2 Settings** menu) and use the  button to start the synchronization.
By selecting either **CH1 Settings** or **CH2 Settings**, you already pre-select the receiving channel with which the transmitter is to be synchronized. This is why the receiving channel selection does not appear.
Once the synchronization has been started, **Hold to IR** appears on the display panel and the infra-red interface flashes blue.



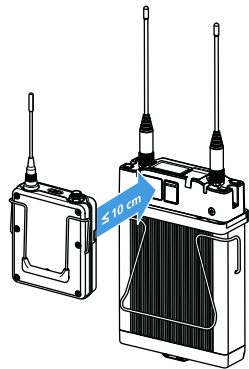

- ▶ Hold the infra-red interface of the switched-on transmitter (see the instruction manual of the transmitter) in front of the infra-red interface of the EK 6042. The frequency set on the EK 6042 is transferred to the transmitter. If the transfer was successful, the status LED of the corresponding receiving channel lights up green – provided that the transmitter is not muted. The radio link is ready for immediate use. If the transfer fails, the message **Failure** appears on the display panel.



Performing an automatic configuration (Auto)

No manual settings are required. The EK 6042 automatically determines suitable settings for the **Transmitter**, **Frequency** and **Squelch** submenus.

- ▶ Long-press the  button. The receiving channel selection appears.
- ▶ Select the receiving channel (**CH1** or **CH2**) for the automatic configuration.
- ▶ Use the  button to start the automatic configuration.



Hold to IR appears on the display panel and the infra-red interface flashes blue.



- ▶ Hold the infra-red interface of the switched-on transmitter (see the instruction manual of the transmitter) in front of the infra-red interface of the EK 6042. The EK 6042 recognizes the transmitter and its frequency range. Subsequently, the infra-red interface stops flashing blue.
- ▶ Now increase the distance between the transmitter and the EK 6042. Depending on the transmitter type, **Increase transmitter distance** may appear on the display panel. In this case, increase the distance even more.

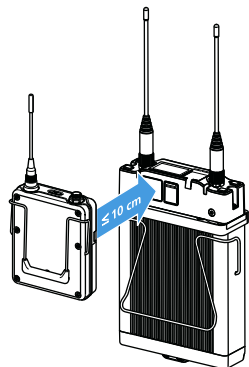

The EK 6042 now automatically determines a suitable frequency as well as the noise level in the environment and makes the corresponding

settings in the **Transmitter**, **Frequency** and **Squelch** submenus.

Then, **Hold to IR** appears again on the display panel and the infra-red interface flashes blue again.



- ▶ Hold the infra-red interface of the transmitter in front of the infra-red interface of the EK 6042.



The determined frequency is transferred to the transmitter. If the transfer was successful, the status LED of the corresponding receiving channel lights up green – provided that the transmitter is not muted. The radio link is ready for immediate use. If the transfer fails, the message **Failure** appears on the display panel.

Performing a frequency scan

You can perform a frequency scan to get an idea of the current frequency situation on site. During a frequency scan, the audio outputs of both receiving channels are muted.

-  To set a receiving frequency, you can use the functions in the **Frequency** submenu of the **CH1 Settings** and **CH2 Settings** menus (see page 16). Alternatively, you can perform an automatic configuration (see page 17).

- ▶ Call up the operating menu (see page 15), select **Spectrum Scan** and confirm the warning message.

The frequency scan starts from the center of the EK 6042 frequency range and scans simultaneously toward the lower and higher frequencies. You can use the  and  buttons to scroll through the entire frequency scan at any time.

- ▶ Press the  button to return to the operating menu.

Changing scenes

If microphones are changed between several takes and there is no time for configuring the devices, you can prepare as follows:

- ▶ Configure the transmitter and the EK 6042 in advance. Store each of the required receiver configurations as a scene (see below). You can store up to 10 scenes.
- ▶ Change to the required configuration without losing time by calling up the stored scene (see page 20).

Storing a scene

- ▶ Set all parameters as desired and synchronize the corresponding transmitters.

- ▶ Call up the operating menu (see page 15) and select **Store Scene**.
The scene selection appears.



- ▶ Select a scene number (**#1 to #10**).
Your configuration is stored under the selected scene number. In doing so, older scenes are overwritten. You can view the configurations of all scenes via a web browser and delete them (see page 20).

Calling up a scene

There are two options to call up a scene.

Option one:

- ▶ Long-press the button.
The scene selection appears. The preset frequencies, the names of the transmitters and the frequency bands of the synchronized transmitters are displayed.



- ▶ Use the or button to select the desired scene number and confirm by pressing the button.
The selected scene becomes effective immediately.

Option two (quick selection):

- ▶ Press and hold the button while simultaneously pressing the button or the button to navigate to the desired scene number.
- ▶ Release the two buttons.
The last selected scene becomes effective and the standard display appears.

Configuring the EK 6042 using a web browser

You can connect the EK 6042 directly to a Windows computer or Mac and configure it using a web browser.

- ▶ When connecting the EK 6042 to a Windows computer, no drivers need to be installed.
- ▶ Install an RNDIS driver on your Mac before connecting the EK 6042. RNDIS drivers for Mac are available free of charge from the Internet.



If you want to connect several EK 6042 simultaneously to your computer, you first have to assign different IP addresses to the receivers via the **Network** menu item.

- ▶ Use the USB cable to connect the EK 6042 to your computer.
The EK 6042 automatically switches on. When connecting to a Windows computer for the first time, the necessary drivers for detecting the EK 6042 are installed. This can take several minutes.
Then, a URL appears on the display panel of the EK 6042.

- ▶ Enter this URL into your web browser.
The web browser displays the following menus:

Licence List

The **Licence List** menu allows you to specify up to 100 freely selectable frequencies which will be selected preferentially during the automatic frequency scan.

Band List

The **Band List** menu allows you to specify up to 25 freely selectable frequency bands which will be selected preferentially during the automatic frequency scan.

If frequencies have been specified in the **Licence List** menu (see above), they will be prioritized over the frequency bands.

Transmitter Profiles

The **Transmitter Profiles** menu contains preset transmitter profiles which are compatible with the EK 6042. These profiles can be viewed via the **Default Profiles** menu item.

The **Custom Profiles** menu item allows you to create custom transmitter profiles and edit them (**Add profile**) or transmitter detection via infra-red interface (**Detect over IR**). Profiles of compatible but unknown transmitters are automatically added.

Scenes

The **Scenes** menu allows you to view the settings of the stored scenes (see also page 19) by clicking on them.

The settings can be deleted by clicking on **X**.

Maintenance

Via this configuration menu, you can, among other things:

- perform a reset of the EK 6042
- import/export configurations
- perform firmware updates

Care and maintenance

ATTENTION

Liquids can damage the electronics of the product.

Liquids entering the housing of the product can cause a short-circuit and damage the electronics.

- ▶ Keep all liquids far away from the product.
- ▶ Do not use any solvents or cleansing agents.

- ▶ Clean the EK 6042 and its accessories with a slightly damp cloth.

Accessories

Product	Cat. No.	Description
EK 6042 A	506210	Portable camera receiver
GA 6042-15	506213	15-pin D-sub adapter for Sony cameras
GA 6042-25	506212	25-pin D-sub adapter for UniSlot/SuperSlot™ cameras
GA 6042 BP	506214	Backpanel adapter
GA 6042 BA	506215	Accupack adapter
CA 6042 XLR	506216	Y-adapter cable (mini-XLR to 2 x XLR)
CA 6042 DC	506217	DC-IN cable
BA 61	504703	Accupack
L 60	504704	Charger for charging the BA 61 accupack

Specifications

RF characteristics

Receiver principle	superheterodyne with digital demodulation
Receiving channels	2
Receiver compatibility	digital modulation: Digital 9000 LR mode wideband FM: HiDyn Plus, HDX
Frequency ranges	470 to 654 MHz
Switching bandwidth	184 MHz
Step width	≥ 5 kHz
Reception diversity	true diversity (2 x 2 receivers)
Sensitivity	LR mode: < -90 dBm FM mode: < -94 dBm @52 dB Audio SNR
Antenna inputs	2 SMA sockets (50 Ω)
Antenna type	2 UHF wideband antennas
Adjacent channel selection	typ. 70 dB (channel spacing ≥ 400 kHz)

Audio characteristics

Audio frequency response	20 Hz to 20 kHz (+/-1.5 dB)
Dynamic range	> 108 dB(A)
THD	LR mode: < 0.03% (at 1 kHz) FM mode: < 0.5% (at 1 kHz)
Latency	LR mode: 3.0 ms (AES3) FM mode: 1.5 ms (AES3)
Audio outputs	5-pin mini XLR (male), balanced
MAIN 1/2	digital: 0 dBFs, AES3, 48 kHz, 24 bit
	analog: -22 dBu to +8 dBu (adjustable)
(Top) AUX 1/2	analog: -22 dBu to +8 dBu (adjustable)

Other characteristics

Dimensions (H x W x D)	approx. 107 x 90 x 26 mm (without antennas)
Weight	approx. 340 g
Configuration interface	micro USB socket, type B
Multi-pin interface	60-pin connector for GA 6042 adapters

Operation with GA 6042 BP backpanel adapter

Power consumption	typ. 3 W at 12 V (7 to 18 V)
Input voltage	4-pin DC IN socket, typ. 12 V (7 to 18 V)
Headphone output	3.5 mm jack socket 2 x 25 mW at 32 Ω
Dimensions (H x W x D)	approx. 135 x 90 x 26 mm
Audio outputs	5-pin mini XLR (male), balanced
MAIN 1/2 digital:	0 dBFs, AES3, 48 kHz, 24 bit
analog:	-22 dBu to +8 dBu (adjustable)
(Top) AUX 1/2 analog:	-22 dBu to +8 dBu (adjustable)

Operation with GA 6042 BA accupack adapter

(requires the GA 6042 BP for operation)

Compatible accupack	Sennheiser BA 61
Operating time	> 4 hours (with 2 x BA 61 accupack)
Dimensions (H x W x D)	approx. 135 x 90 x 44 mm

Operation with D-sub adapters

D-sub adapter	GA 6042-15	GA 6042-25
Camera interface	D-sub-15 (male) (Sony)	D-sub-25 (male) (UniSlot/SuperSlot™)
Dimensions (H x W x D)	approx. 135 x 90 x 26 mm	

Operating conditions

Ambient temperature	-10°C to +55°C
Relative air humidity	max. 90% at 40°C (non-condensing)
Protection against dripping and light splashing of liquids	The product must not be exposed to dripping and splashing (IP2X).

Storage and transport conditions

Ambient temperature	-25°C to +70°C
Relative air humidity	max. 90% at 40°C
Protection against dripping and light splashing of liquids	The product must not be exposed to dripping and splashing (IP2X).
Shock resistance	as per IEC 68 or EN 60068, T2-27

Licenses

This product includes software code developed by third parties. Please find below a list of all used third party files.

eCos

Copyright (c) 2014, eCosCentric Ltd. All rights reserved.

Redistribution and use in source and binary forms, with or without modification, are permitted provided that the following conditions are met:

- Redistributions of source code must retain the above copyright notice, this list of conditions and the following disclaimer.
- Redistributions in binary form must reproduce the above copyright notice, this list of conditions and the following disclaimer in the documentation and/or other materials provided with the distribution.
- Neither the name of the copyright holder nor the names of its contributors may be used to endorse or promote products derived from this software without specific prior written permission.

THIS SOFTWARE IS PROVIDED BY THE COPYRIGHT HOLDERS AND CONTRIBUTORS "AS IS" AND ANY EXPRESS OR IMPLIED WARRANTIES, INCLUDING, BUT NOT LIMITED TO, THE IMPLIED WARRANTIES OF MERCHANTABILITY AND FITNESS FOR A PARTICULAR PURPOSE ARE DISCLAIMED. IN NO EVENT SHALL THE COPYRIGHT HOLDER OR CONTRIBUTORS BE LIABLE FOR ANY DIRECT, INDIRECT, INCIDENTAL, SPECIAL, EXEMPLARY, OR CONSEQUENTIAL DAMAGES (INCLUDING, BUT NOT LIMITED TO, PROCUREMENT OF SUBSTITUTE GOODS OR SERVICES; LOSS OF USE, DATA, OR PROFITS; OR BUSINESS INTERRUPTION) HOWEVER CAUSED AND ON ANY THEORY OF LIABILITY, WHETHER IN CONTRACT, STRICT LIABILITY, OR TORT (INCLUDING NEGLIGENCE OR OTHERWISE) ARISING IN ANY WAY OUT OF THE USE OF THIS SOFTWARE, EVEN IF ADVISED OF THE POSSIBILITY OF SUCH DAMAGE.

Display Font (Palm OS)

Copyright (c) 2012 DamienG

Used under the terms of the Creative Commons License.

http://fontstruct.com/fontstructions/show/palm_os

DHCP Server (dhcps)

Copyright (c) 2010, Valhalla Wireless, Todd Elliott

<http://valhalla-wireless.com/>All rights reserved.

Redistribution and use in source and binary forms, with or without modification, are permitted provided that the following conditions are met:

- Redistributions of source code must retain the above copyright notice, this list of conditions and the following disclaimer.
- Redistributions in binary form must reproduce the above copyright notice, this list of conditions and the following disclaimer in the documentation and/or other materials provided with the distribution.

- Neither the name of the Valhalla Wireless nor the names of its contributors may be used to endorse or promote products derived from this software without specific prior written permission.

THIS SOFTWARE IS PROVIDED BY THE COPYRIGHT HOLDERS AND CONTRIBUTORS "AS IS" AND ANY EXPRESS OR IMPLIED WARRANTIES, INCLUDING, BUT NOT LIMITED TO, THE IMPLIED WARRANTIES OF MERCHANTABILITY AND FITNESS FOR A PARTICULAR PURPOSE ARE DISCLAIMED. IN NO EVENT SHALL Valhalla Wireless BE LIABLE FOR ANY DIRECT, INDIRECT, INCIDENTAL, SPECIAL, EXEMPLARY, OR CONSEQUENTIAL DAMAGES (INCLUDING, BUT NOT LIMITED TO, PROCUREMENT OF SUBSTITUTE GOODS OR SERVICES; LOSS OF USE, DATA, OR PROFITS; OR BUSINESS INTERRUPTION) HOWEVER CAUSED AND ON ANY THEORY OF LIABILITY, WHETHER IN CONTRACT, STRICT LIABILITY, OR TORT (INCLUDING NEGLIGENCE OR OTHERWISE) ARISING IN ANY WAY OUT OF THE USE OF THIS SOFTWARE, EVEN IF ADVISED OF THE POSSIBILITY OF SUCH DAMAGE.

The Creative Commons License

THE WORK (AS DEFINED BELOW) IS PROVIDED UNDER THE TERMS OF THIS CREATIVE COMMONS PUBLIC LICENSE ("CCPL" OR "LICENSE"). THE WORK IS PROTECTED BY COPYRIGHT AND/OR OTHER APPLICABLE LAW. ANY USE OF THE WORK OTHER THAN AS AUTHORIZED UNDER THIS LICENSE OR COPYRIGHT LAW IS PROHIBITED.

BY EXERCISING ANY RIGHTS TO THE WORK PROVIDED HERE, YOU ACCEPT AND AGREE TO BE BOUND BY THE TERMS OF THIS LICENSE. TO THE EXTENT THIS LICENSE MAY BE CONSIDERED TO BE A CONTRACT, THE LICENSOR GRANTS YOU THE RIGHTS CONTAINED HERE IN CONSIDERATION OF YOUR ACCEPTANCE OF SUCH TERMS AND CONDITIONS.

1. Definitions

- a. **"Adaptation"** means a work based upon the Work, or upon the Work and other pre-existing works, such as a translation, adaptation, derivative work, arrangement of music or other alterations of a literary or artistic work, or phonogram or performance and includes cinematographic adaptations or any other form in which the Work may be recast, transformed, or adapted including in any form recognizably derived from the original, except that a work that constitutes a Collection will not be considered an Adaptation for the purpose of this License. For the avoidance of doubt, where the Work is a musical work, performance or phonogram, the synchronization of the Work in timed-relation with a moving image ("synching") will be considered an Adaptation for the purpose of this License.
- b. **"Collection"** means a collection of literary or artistic works, such as encyclopedias and anthologies, or performances, phonograms or broadcasts, or other works or subject matter other than works listed in Section 1(f) below, which, by reason of the selection and arrangement of their contents, constitute intellectual creations, in which the Work is included in its entirety in unmodified form along with one or more other contributions, each constituting separate and independent works in themselves, which together are assembled into a collective whole. A work that constitutes a Collection will not be consid-

ered an Adaptation (as defined below) for the purposes of this License.

- c. **“Creative Commons Compatible License”** means a license that is listed at <https://creativecommons.org/compatiblelicenses> that has been approved by Creative Commons as being essentially equivalent to this License, including, at a minimum, because that license: (i) contains terms that have the same purpose, meaning and effect as the License Elements of this License; and, (ii) explicitly permits the relicensing of adaptations of works made available under that license under this License or a Creative Commons jurisdiction license with the same License Elements as this License.
- d. **“Distribute”** means to make available to the public the original and copies of the Work or Adaptation, as appropriate, through sale or other transfer of ownership.
- e. **“License Elements”** means the following high-level license attributes as selected by Licensor and indicated in the title of this License: Attribution, ShareAlike.
- f. **“Licensor”** means the individual, individuals, entity or entities that offer(s) the Work under the terms of this License.
- g. **“Original Author”** means, in the case of a literary or artistic work, the individual, individuals, entity or entities who created the Work or if no individual or entity can be identified, the publisher; and in addition (i) in the case of a performance the actors, singers, musicians, dancers, and other persons who act, sing, deliver, declaim, play in, interpret or otherwise perform literary or artistic works or expressions of folklore; (ii) in the case of a phonogram the producer being the person or legal entity who first fixes the sounds of a performance or other sounds; and, (iii) in the case of broadcasts, the organization that transmits the broadcast.
- h. **“Work”** means the literary and/or artistic work offered under the terms of this License including without limitation any production in the literary, scientific and artistic domain, whatever may be the mode or form of its expression including digital form, such as a book, pamphlet and other writing; a lecture, address, sermon or other work of the same nature; a dramatic or dramatico-musical work; a choreographic work or entertainment in dumb show; a musical composition with or without words; a cinematographic work to which are assimilated works expressed by a process analogous to cinematography; a work of drawing, painting, architecture, sculpture, engraving or lithography; a photographic work to which are assimilated works expressed by a process analogous to photography; a work of applied art; an illustration, map, plan, sketch or three-dimensional work relative to geography, topography, architecture or science; a performance; a broadcast; a phonogram; a compilation of data to the extent it is protected as a copyrightable work; or a work performed by a variety or circus performer to the extent it is not otherwise considered a literary or artistic work.
- i. **“You”** means an individual or entity exercising rights under this License who has not previously violated the terms of this License with respect to the Work, or who has received express permission from

the Licensor to exercise rights under this License despite a previous violation.

- j. **“Publicly Perform”** means to perform public recitations of the Work and to communicate to the public those public recitations, by any means or process, including by wire or wireless means or public digital performances; to make available to the public Works in such a way that members of the public may access these Works from a place and at a place individually chosen by them; to perform the Work to the public by any means or process and the communication to the public of the performances of the Work, including by public digital performance; to broadcast and rebroadcast the Work by any means including signs, sounds or images.
- k. **“Reproduce”** means to make copies of the Work by any means including without limitation by sound or visual recordings and the right of fixation and reproducing fixations of the Work, including storage of a protected performance or phonogram in digital form or other electronic medium.

2. Fair Dealing Rights. Nothing in this License is intended to reduce, limit, or restrict any uses free from copyright or rights arising from limitations or exceptions that are provided for in connection with the copyright protection under copyright law or other applicable laws.

3. License Grant. Subject to the terms and conditions of this License, Licensor hereby grants You a worldwide, royalty-free, non-exclusive, perpetual (for the duration of the applicable copyright) license to exercise the rights in the Work as stated below:

- a. to Reproduce the Work, to incorporate the Work into one or more Collections, and to Reproduce the Work as incorporated in the Collections;
- b. to create and Reproduce Adaptations provided that any such Adaptation, including any translation in any medium, takes reasonable steps to clearly label, demarcate or otherwise identify that changes were made to the original Work. For example, a translation could be marked “The original work was translated from English to Spanish.” or a modification could indicate “The original work has been modified.”;
- c. to Distribute and Publicly Perform the Work including as incorporated in Collections; and,
- d. to Distribute and Publicly Perform Adaptations.
- e. For the avoidance of doubt:
 - i. **Non-waivable Compulsory License Schemes.** In those jurisdictions in which the right to collect royalties through any statutory or compulsory licensing scheme cannot be waived, the Licensor reserves the exclusive right to collect such royalties for any exercise by You of the rights granted under this License;
 - ii. **Waivable Compulsory License Schemes.** In those jurisdictions in which the right to collect royalties through any statutory or compulsory licensing scheme can be waived, the Licensor waives the exclusive right to collect such royalties for any exercise by You of the rights granted under this License; and,

- iii. Voluntary License Schemes. The Licensor waives the right to collect royalties, whether individually or, in the event that the Licensor is a member of a collecting society that administers voluntary licensing schemes, via that society, from any exercise by You of the rights granted under this License.

The above rights may be exercised in all media and formats whether now known or hereafter devised. The above rights include the right to make such modifications as are technically necessary to exercise the rights in other media and formats. Subject to Section 8(f), all rights not expressly granted by Licensor are hereby reserved.

4. Restrictions. The license granted in Section 3 above is expressly made subject to and limited by the following restrictions:

- a. You may Distribute or Publicly Perform the Work only under the terms of this License. You must include a copy of, or the Uniform Resource Identifier (URI) for, this License with every copy of the Work You Distribute or Publicly Perform. You may not offer or impose any terms on the Work that restrict the terms of this License or the ability of the recipient of the Work to exercise the rights granted to that recipient under the terms of the License. You may not sublicense the Work. You must keep intact all notices that refer to this License and to the disclaimer of warranties with every copy of the Work You Distribute or Publicly Perform. When You Distribute or Publicly Perform the Work, You may not impose any effective technological measures on the Work that restrict the ability of a recipient of the Work from You to exercise the rights granted to that recipient under the terms of the License. This Section 4(a) applies to the Work as incorporated in a Collection, but this does not require the Collection apart from the Work itself to be made subject to the terms of this License. If You create a Collection, upon notice from any Licensor You must, to the extent practicable, remove from the Collection any credit as required by Section 4(c), as requested. If You create an Adaptation, upon notice from any Licensor You must, to the extent practicable, remove from the Adaptation any credit as required by Section 4(c), as requested.
- b. You may Distribute or Publicly Perform an Adaptation only under the terms of: (i) this License; (ii) a later version of this License with the same License Elements as this License; (iii) a Creative Commons jurisdiction license (either this or a later license version) that contains the same License Elements as this License (e.g., Attribution-ShareAlike 3.0 US); (iv) a Creative Commons Compatible License. If you license the Adaptation under one of the licenses mentioned in (iv), you must comply with the terms of that license. If you license the Adaptation under the terms of any of the licenses mentioned in (i), (ii) or (iii) (the "Applicable License"), you must comply with the terms of the Applicable License generally and the following provisions: (I) You must include a copy of, or the URI for, the Applicable License with every copy of each Adaptation You Distribute or Publicly Perform; (II) You may not offer or impose any terms on the Adaptation that restrict the terms of the Applicable License or the ability of the recipient of the Adaptation to exercise the rights granted to that

recipient under the terms of the Applicable License; (III) You must keep intact all notices that refer to the Applicable License and to the disclaimer of warranties with every copy of the Work as included in the Adaptation You Distribute or Publicly Perform; (IV) when You Distribute or Publicly Perform the Adaptation, You may not impose any effective technological measures on the Adaptation that restrict the ability of a recipient of the Adaptation from You to exercise the rights granted to that recipient under the terms of the Applicable License. This Section 4(b) applies to the Adaptation as incorporated in a Collection, but this does not require the Collection apart from the Adaptation itself to be made subject to the terms of the Applicable License.

- c. If You Distribute, or Publicly Perform the Work or any Adaptations or Collections, You must, unless a request has been made pursuant to Section 4(a), keep intact all copyright notices for the Work and provide, reasonable to the medium or means You are utilizing: (i) the name of the Original Author (or pseudonym, if applicable) if supplied, and/or if the Original Author and/or Licensor designate another party or parties (e.g., a sponsor institute, publishing entity, journal) for attribution (“Attribution Parties”) in Licensor’s copyright notice, terms of service or by other reasonable means, the name of such party or parties; (ii) the title of the Work if supplied; (iii) to the extent reasonably practicable, the URI, if any, that Licensor specifies to be associated with the Work, unless such URI does not refer to the copyright notice or licensing information for the Work; and (iv) , consistent with Section 3(b), in the case of an Adaptation, a credit identifying the use of the Work in the Adaptation (e.g., “French translation of the Work by Original Author”, or “Screenplay based on original Work by Original Author”). The credit required by this Section 4(c) may be implemented in any reasonable manner; provided, however, that in the case of a Adaptation or Collection, at a minimum such credit will appear, if a credit for all contributing authors of the Adaptation or Collection appears, then as part of these credits and in a manner at least as prominent as the credits for the other contributing authors. For the avoidance of doubt, You may only use the credit required by this Section for the purpose of attribution in the manner set out above and, by exercising Your rights under this License, You may not implicitly or explicitly assert or imply any connection with, sponsorship or endorsement by the Original Author, Licensor and/or Attribution Parties, as appropriate, of You or Your use of the Work, without the separate, express prior written permission of the Original Author, Licensor and/or Attribution Parties.
- d. Except as otherwise agreed in writing by the Licensor or as may be otherwise permitted by applicable law, if You Reproduce, Distribute or Publicly Perform the Work either by itself or as part of any Adaptations or Collections, You must not distort, mutilate, modify or take other derogatory action in relation to the Work which would be prejudicial to the Original Author’s honor or reputation. Licensor agrees that in those jurisdictions (e.g. Japan), in which any exercise of the right granted in Section 3(b) of this License (the right to make Adaptations) would be deemed to be a distortion, mutilation, modifica-

tion or other derogatory action prejudicial to the Original Author's honor and reputation, the Licensor will waive or not assert, as appropriate, this Section, to the fullest extent permitted by the applicable national law, to enable You to reasonably exercise Your right under Section 3(b) of this License (right to make Adaptations) but not otherwise.

5. Representations, Warranties and Disclaimer. UNLESS OTHERWISE MUTUALLY AGREED TO BY THE PARTIES IN WRITING, LICENSOR OFFERS THE WORK AS-IS AND MAKES NO REPRESENTATIONS OR WARRANTIES OF ANY KIND CONCERNING THE WORK, EXPRESS, IMPLIED, STATUTORY OR OTHERWISE, INCLUDING, WITHOUT LIMITATION, WARRANTIES OF TITLE, MERCHANTABILITY, FITNESS FOR A PARTICULAR PURPOSE, NONINFRINGEMENT, OR THE ABSENCE OF LATENT OR OTHER DEFECTS, ACCURACY, OR THE PRESENCE OF ABSENCE OF ERRORS, WHETHER OR NOT DISCOVERABLE. SOME JURISDICTIONS DO NOT ALLOW THE EXCLUSION OF IMPLIED WARRANTIES, SO SUCH EXCLUSION MAY NOT APPLY TO YOU.

6. Limitation on Liability. EXCEPT TO THE EXTENT REQUIRED BY APPLICABLE LAW, IN NO EVENT WILL LICENSOR BE LIABLE TO YOU ON ANY LEGAL THEORY FOR ANY SPECIAL, INCIDENTAL, CONSEQUENTIAL, PUNITIVE OR EXEMPLARY DAMAGES ARISING OUT OF THIS LICENSE OR THE USE OF THE WORK, EVEN IF LICENSOR HAS BEEN ADVISED OF THE POSSIBILITY OF SUCH DAMAGES.

7. Termination

- a. This License and the rights granted hereunder will terminate automatically upon any breach by You of the terms of this License. Individuals or entities who have received Adaptations or Collections from You under this License, however, will not have their licenses terminated provided such individuals or entities remain in full compliance with those licenses. Sections 1, 2, 5, 6, 7, and 8 will survive any termination of this License.
- b. Subject to the above terms and conditions, the license granted here is perpetual (for the duration of the applicable copyright in the Work). Notwithstanding the above, Licensor reserves the right to release the Work under different license terms or to stop distributing the Work at any time; provided, however that any such election will not serve to withdraw this License (or any other license that has been, or is required to be, granted under the terms of this License), and this License will continue in full force and effect unless terminated as stated above.

8. Miscellaneous

- a. Each time You Distribute or Publicly Perform the Work or a Collection, the Licensor offers to the recipient a license to the Work on the same terms and conditions as the license granted to You under this License.
- b. Each time You Distribute or Publicly Perform an Adaptation, Licensor offers to the recipient a license to the original Work on the same terms and conditions as the license granted to You under this License.

- c. If any provision of this License is invalid or unenforceable under applicable law, it shall not affect the validity or enforceability of the remainder of the terms of this License, and without further action by the parties to this agreement, such provision shall be reformed to the minimum extent necessary to make such provision valid and enforceable.
- d. No term or provision of this License shall be deemed waived and no breach consented to unless such waiver or consent shall be in writing and signed by the party to be charged with such waiver or consent.
- e. This License constitutes the entire agreement between the parties with respect to the Work licensed here. There are no understandings, agreements or representations with respect to the Work not specified here. Licensor shall not be bound by any additional provisions that may appear in any communication from You. This License may not be modified without the mutual written agreement of the Licensor and You.
- f. The rights granted under, and the subject matter referenced, in this License were drafted utilizing the terminology of the Berne Convention for the Protection of Literary and Artistic Works (as amended on September 28, 1979), the Rome Convention of 1961, the WIPO Copyright Treaty of 1996, the WIPO Performances and Phonograms Treaty of 1996 and the Universal Copyright Convention (as revised on July 24, 1971). These rights and subject matter take effect in the relevant jurisdiction in which the License terms are sought to be enforced according to the corresponding provisions of the implementation of those treaty provisions in the applicable national law. If the standard suite of rights granted under applicable copyright law includes additional rights not granted under this License, such additional rights are deemed to be included in the License; this License is not intended to restrict the license of any rights under applicable law.

Pin assignment

5-Pin-Mini-XLR (Male) AES3 MAIN 1/2, AUX 1/2, (Top) AUX

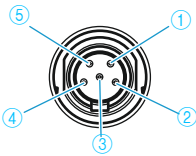

- ① GND
- ② CH 1 (+)
- ③ CH 1 (-)
- ④ CH 2 (+)
- ⑤ CH 2 (-)

DC-IN

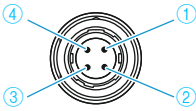

- ① GND
- ② -
- ③ -
- ④ Power

CA 6042 XLR Cable

3-Pin-XLR (Female) MAIN 2/AUX 2	5-Pin-Mini-XLR (Female)	3-Pin-XLR (Female) MAIN 1/AUX 1
<p>① GND</p>	<p>① GND</p>	<p>① GND</p>
	<p>② + (black) ③ - (green)</p>	<p>② + (black) ③ - (green)</p>
<p>④ + (white) ⑤ - (red)</p>	<p>④ + (white) ⑤ - (red)</p>	

D-Sub-15

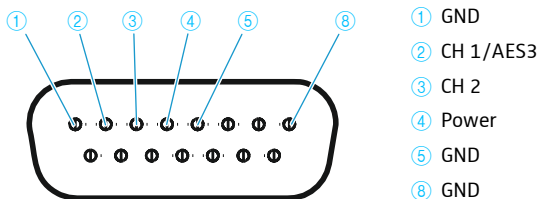

D-Sub-25

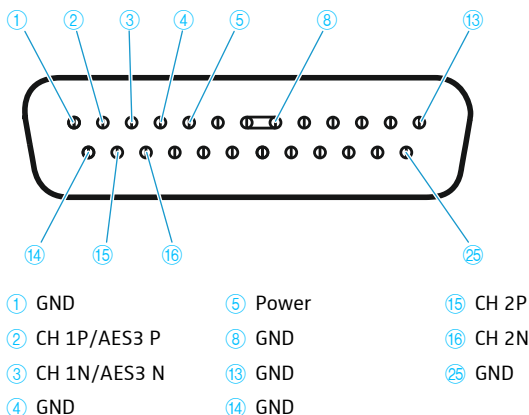

Unbelegte Pins dürfen nicht mit einem Signal belegt werden.

Unassigned pins must not be wired.

Les broches non assignées ne doivent pas être connectées.

I pin liberi non possono essere occupati da un segnale.

Los pines que no estén ocupados no se deben ocupar con una señal.

Os pinos sem ocupação não podem ser ocupados com um sinal.

Niet bezette pins mogen niet op een signaal worden aangesloten.

На неиспользуемые выводы не должны подаваться сигналы.

空闲的针脚不得被分配信号。



Sennheiser electronic GmbH & Co. KG

Am Labor 1, 30900 Wedemark, Germany

www.sennheiser.com

Publ. 06/19, 560088/A05