

BVM-E / BVM-F / PVM Series OLED Monitor

SONY
make.believe



BVM-E250 / BVM-E170

Professional OLED Master Monitor

BVM-F250 / BVM-F170

Professional OLED Master Monitor

PVM-2541 / PVM-1741 / PVM-740

Professional OLED Picture Monitor

TRIMASTER EL

TRIMASTER EL

Sony's OLED – Re-defining the Master Monitor and Picture Monitor

Sony is proud to introduce its much-anticipated Organic Light-Emitting Diode (OLED) monitor line-up: the BVM-E Series BVM-E250^{*1} and BVM-E170^{*2} master monitors, BVM-F Series BVM-F250^{*1} and BVM-F170^{*2} master monitors, and PVM Series PVM-2541^{*1} and PVM-1741^{*2} picture monitors.

Sony is capable of extraordinary innovation in reference monitor development, as the company builds on over 30 continuous years of BVM master monitor experience, and is the world leader in OLED display devices and signal processing engines.

Sony has developed these 24.5-inch and 16.5-inch OLED display panels for critical professional use. The OLED is a self-emitting device, and can deliver deep black, high-contrast, accurate colour reproduction, and quick response with virtually no motion blur. And yet it features a wide colour gamut, meeting ITU-R BT.709, EBU, and SMPTE-C broadcast standards, and conforming to the wider DCI-P3 colour gamut.^{*3}

Furthermore, the newly developed OLED processor with cutting-edge technology offers quality consistency, superb uniformity, and long-term reliability.

Sony optimizes the potential of the OLED panel using unique Super Top Emission OLED technology along with the dedicated OLED processor. The combination of these technological developments elevate the BVM-E, BVM-F, and PVM Series to a new level of next-generation master monitors and picture monitors, re-setting the industry's ultimate reference point.

With Sony's OLED fully unleashed, Sony starts a new and important chapter in professional monitor history.

^{*1} 24.5-inch (623.4 mm), measured diagonally.

^{*2} 16.5-inch (419.7 mm), measured diagonally.

^{*3} The colour gamut described in SMPTE RP 431-2-2007. The chromaticity of the green-red region is not covered in full.

TRIMASTER EL

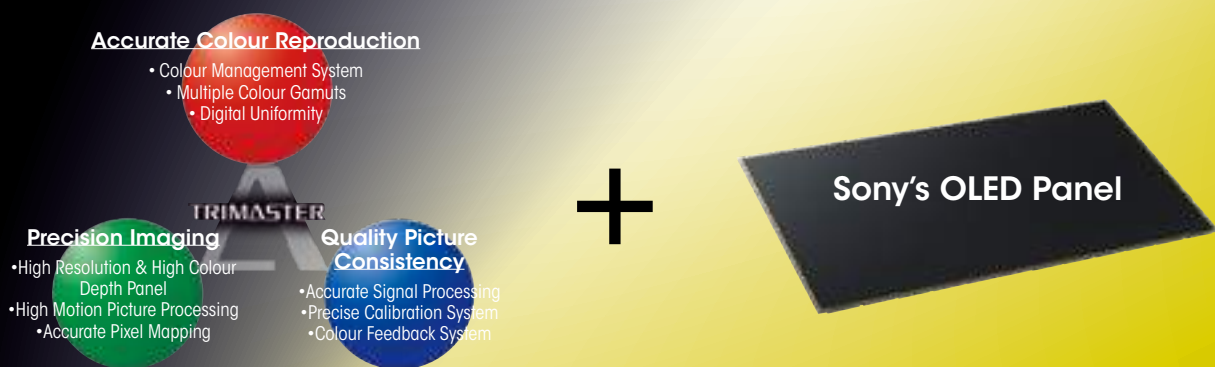

TRIMASTER™ Technology is a design architecture used to elicit the full performance capabilities of professional flat-panel displays. It comprises the core technologies that enable the highest level of colour accuracy, precision imaging, and picture-quality consistency. EL (Electro-Luminescence) is an ideal self-emission display device with a wide dynamic range and high picture quality. By refining TRIMASTER technology with the new EL device, Sony effectively boosts the performance expectations of the professional industry.

Sony's Unique OLED Technology

- 24.5-inch / 16.5-inch "Full HD 10bit"
- Sony's "Super Top Emission"
- High Accuracy OLED Processor

Sony's Super Top Emission OLED Panel

- Accurate black reproduction
- Accurate colour reproduction
- Wide dynamic range
- Fast response time



Sony's Original OLED Processor

- Designed specifically for Sony's OLED panel
- Accurate gamma control of extreme black details
- Superb picture uniformity and reliability



OLED Master Monitor

BVM-E Series



BVM-E250



BVM-E170

The groundbreaking BVM-E250 and BVM-E170 are Sony's OLED reference monitors, incorporating leading-edge technologies to bring out the full performance capabilities required for critical picture evaluation, where accuracy, stability, and consistency are everything.

BVM-F Series

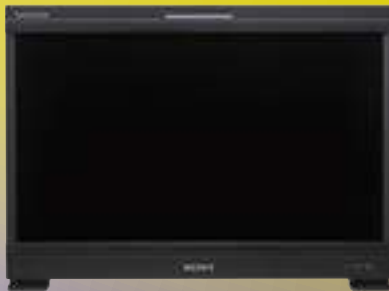

BVM-F250



BVM-F170

The BVM-F250 and BVM-F170 inherit the same technology and performance of BVM-E Series master monitors, and are optimized for TV production and broadcasting applications.

OLED Picture Monitor

PVM Series



PVM-2541



PVM-1741



PVM-740

The PVM-2541 and PVM-1741, as well as the PVM-740, are all-in-one OLED picture monitors for a wide range of applications, delivering unparalleled picture quality with the performance features and functions found in more expensive monitors, all contained in a compact, stylish design.

Picture Monitor

Reference Monitor

Quality / Performance



PVM Series

Standard Panel

- Stunning OLED performance
- Full HD (1920 x 1080) *1
- RGB 10bit Driver

Standard Engine

- 10-bit engine

BVM-F Series

BVM F Panel

Strictly controlled tolerance in addition to the standard panel performance.

Professional Display Engine

- 12-bit engine
- Accurate gamma control of extreme black details
- Cutting-edge I/P conversion with extremely low process delay
- Sophisticated non-linear cubic conversion colour management

BVM-E Series

BVM E Panel

Designed as the highest performance panel. Used for the most critical picture evaluation needs.



• 3G-SDI (x 2)*1 • RGB 4:4:4*1 • HDMI • Auto White Adjustment*2 • Time code*1 • Audio Level Meter*3 • DC operation (17")

PVM Functions

- Waveform
- Audio

Standard Features

BVM Advanced Functions

- Option port x 4 (BKM x 6 selection)
- Dual Link*3
- DisplayPort (x1)
- Interlace display
- Pixel zoom
- HD frame capture
- 24P/PsF@72 Hz display
- 3D analysis*3

Digital Cinema Features

- 2K (2048 x 1080 RGB/XYZ) input
- ASC CDL*2 • User LUT*2
- P&P (Wipe, Butterfly, Blending)

Functionality



*1 Not applicable for PVM-740.

*2 Supported by firmware V1.1 or later.

*3 Option board required for BVM.

Sony's OLED – RGB 10-bit, Full HD

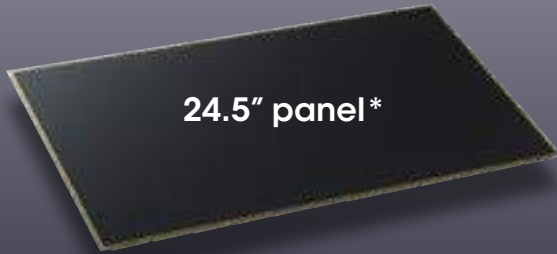

- Sony's unique Super Top Emission technology
- Deep black with wide dynamic range
- Quick response with virtually no motion blur
- Wide colour gamut and accurate colour reproduction

* 623.4 mm, and 419.7 mm (respectively), measured diagonally.

▲ Sony's OLED – Self-emitting Display Device

Sony's OLED creates light by recombining an electron and a hole within certain organic materials. The process of emitting light is extremely efficient when compared to other technologies currently used for display. Its organic materials react to the control of the electrical current immediately, and do not emit light in the absence of an electrical current. In this way, the OLED display panel features superb black performance and quick response to fast-motion pictures. In addition, Sony's OLED display panel delivers a wider colour gamut.

▲ Super Top Emission Technology

Sony's Super Top Emission OLED panel is designed to deliver light emission with the TFT layer on the rear side of the panel. Therefore, the top emission structure offers more efficient light emission than is typical with bottom emission structures where TFT layers are placed on the front side of the panel, limiting the light-emission aperture.

This Super Top Emission technology has a micro-cavity structure which incorporates colour filters. This cavity structure uses an optical resonance effect to enhance colour purity and improve light-emission efficiency. In addition, the colour filter of each RGB also enhances the colour purity of emitted light, and reduces ambient light reflection.

Sony's Super Top Emission OLED panel is completely sealed by a glass substrate, and the electroluminescent layer is fully isolated from outside air and moisture. This contributes to stability and reliability.

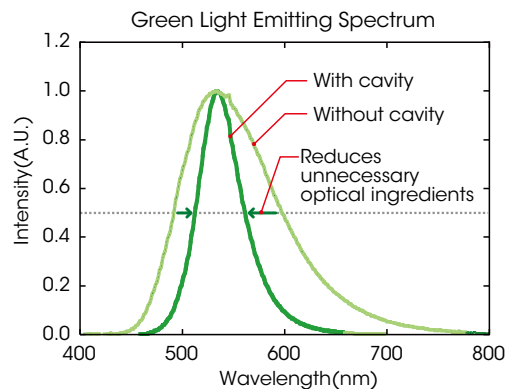
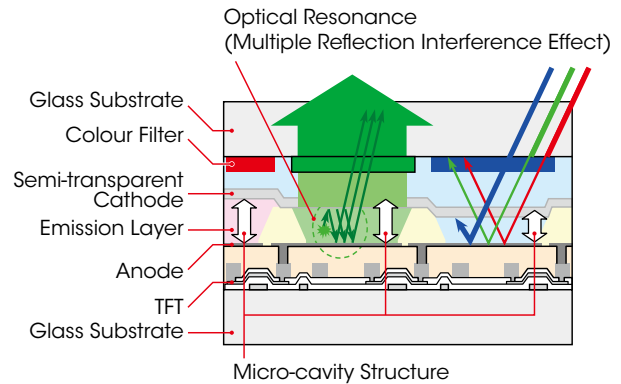



The OLED processor - Dedicated to eliciting full performance.

- Accurate signal processing across all signal levels
- Accurate gamma control
- Superb uniformity control

▲ Dedicated Sony's OLED Processor*

The BVM-E, BVM-F, and PVM Series of OLED monitors incorporate newly developed OLED-dedicated signal processors to elicit and maximize OLED panel performance. This technology allows these TRIMASTER EL™ monitors to provide the level of performance required for critical imaging. These processors accurately control gamma and uniformity, and deliver precision stability control.

* The PVM-740 is equipped with a different processing technology (ChromaTRU™).

Accurate gamma control

Since Sony's OLED panel can display a deeper black than any other display device, the OLED processor controls gamma accuracy (black reproduction) by increased signal processing bit depth.

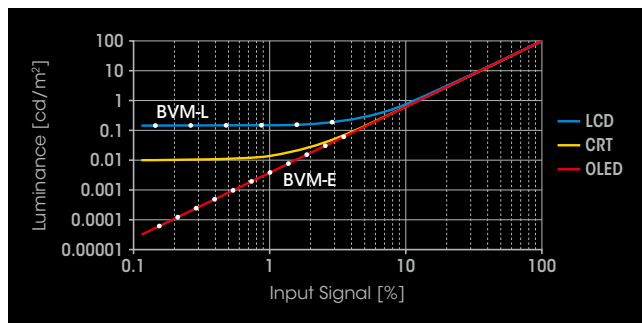

Superb uniformity control

Sony's OLED processor offers superb uniformity across all signal levels at every point of the screen. At the factory, OLED-panel uniformity is precisely measured and corrected using a proprietary RGB LUT (look-up table) adjustment system.

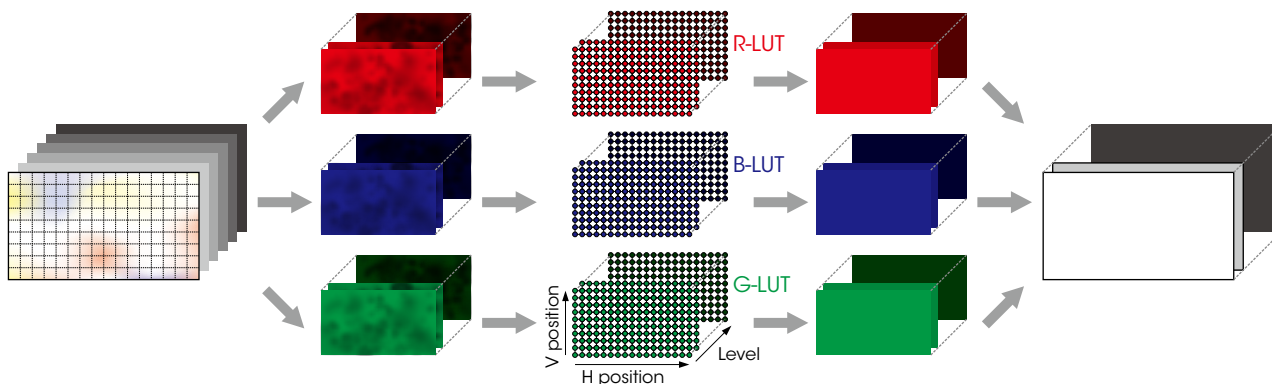

▲ Accurate Black Reproduction

A key advantage of Sony's OLED is the fact that each pixel can be turned completely off. No other display technology is able to offer this. LCD either raises black luminance due to intrinsic light leakage, or reduces black luminance with artificial local dimming technologies. CRT always applies a bias voltage to place the gun at the proper operating level. All of these display devices have some limitation in accuracy of black reproduction. In comparison, Sony's OLED is capable of reproducing accurate black with each individual pixel, enabling users to evaluate each picture image faithfully to the signal.

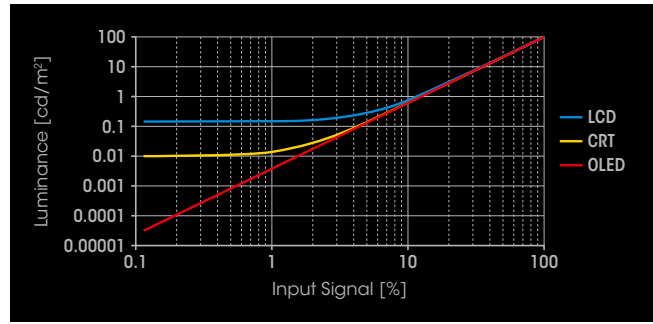

Grey scale images corresponding to the input signal
* Grey scales are simulated images.



LCD*



Sony's OLED*

* Simulated images

▲ Accurate Colour Reproduction

Sony's Super Top Emission technology not only offers a wide colour gamut with its purity of the three primary colours, but also maintains this wide colour gamut throughout the entire luminance range. While all other display devices have limitations in reproducing accurate colours, especially in the low signal levels, Sony's OLED system is truly an ideal display device for picture evaluation. With OLED, users see the details in the blacks, and see the colours as well.

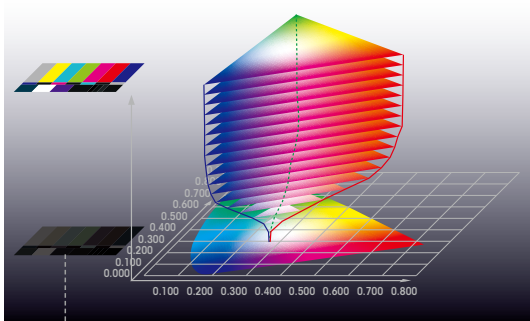

LCD*

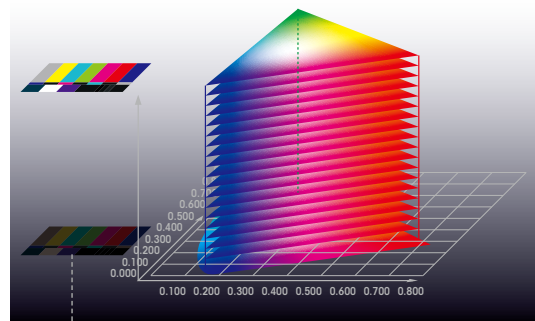

Sony's OLED*



* Colour gamut images based on Sony's test results

Quick Response with Virtually No Motion Blur

The Sony's OLED grey-to-grey switching speed (measured in microseconds, μs) is much faster than that of the LCD (measured in milliseconds, ms).* This fast response benefits a variety of applications and uses. For example, in sports broadcasting, when camera pans would become blurred with an LCD, they remain sharp and clear with OLED. And with moving titles or graphics, when text can be difficult to read on an LCD, OLED displays clear text, regardless of speed or direction.

* Sony's test results.

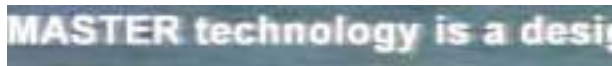
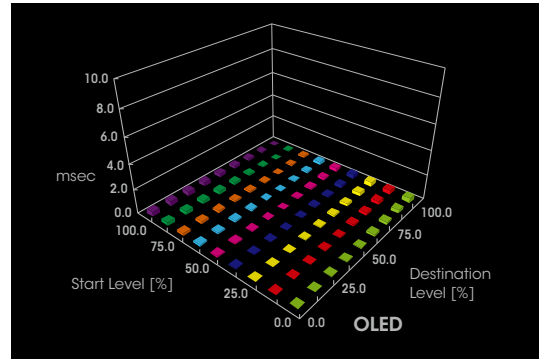
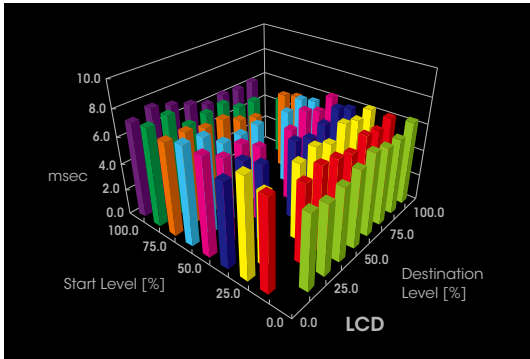

LCD*

Sony's OLED*

* Simulated images

Wide Dynamic Range

Sony's OLED technology has the ability to control each individual pixel from an absolute black to peak white. Each pixel can display the entire dynamic range of the image with no interference to the adjacent pixels.

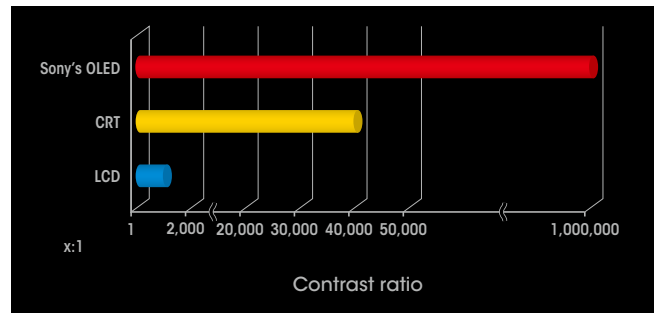

LCD*



Sony's OLED*

* Simulated images

OLED Master Monitor

For Critical Picture Evaluation

BVM-E Series

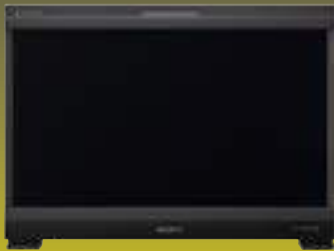

BVM-E250

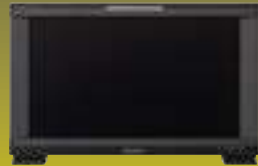

BVM-E170

BVM-F Series



BVM-F250

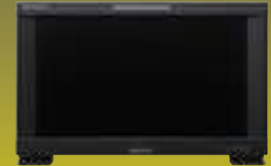

BVM-F170

The groundbreaking BVM-E250 and BVM-E170, and BVM-F250 and BVM-F170 are reference monitors, using Sony's OLED system and incorporating leading-edge technologies to bring out the full performance capabilities required for critical picture evaluation, where accuracy is everything.

- Sony's OLED uses Sony's SuperTop Emission technology with 10-bit RGB panels and OLED processing
- Professional display engine
 - Nonlinear Cubic Conversion colour management system
 - Cutting-edge I/P conversion technology with extremely low process delay
 - 12-bit output accuracy signal processing
- Input versatility
 - Standard Input: 3G/HD/SD-SDI (x2) (selectable input), HDMI™ (HDCP) (x1), DisplayPort (x1) *1
 - Four option slots for input expansion: Six optional BKM boards are available for different needs
- Leading-edge features
 - Interlace Display, HD Frame Capture, Pixel Zoom, P&P (Side-by-side, Butterfly*2, Wipe*2, Blending*2)
- Cinema features (BVM-E Series only)
 - Wide colour gamut: D-Cine conforming to DCI-P3, BVM Native offering the widest colour gamut
 - High frame rate: 24P/PsF, 25P/PsF are displayed at 72 Hz and 75 Hz respectively
 - 2K Cinema formats with multiple display modes
(Full image display, or Native pixel-to-pixel display with an Image-slide function)
 - ASC CDL (American Society of Cinematographers Colour Decision List) *1 and User LUT *1
- Auto white adjustment with PC application software *1
- 3D signal analysis (as a 2D monitor) with optional BKM-250TG 3G-SDI input adaptor
- Closed caption display with optional BKM-244CC HD/SD-SDI closed caption adaptor

*1 Available from firmware V1.1 or later.

*2 BVM-E Series only.



Professional Display Engine (BVM-E / BVM-F Series-dedicated)

- Nonlinear Cubic Conversion colour management system
- Cutting-edge I/P conversion technology with extremely low process delay
- 12-bit output accuracy signal processing

Professional Display Engine

The high-precision signal processing engine has been developed to fulfill the master monitor criteria and is optimized to maximize OLED panel performance. This engine incorporates 12-bit output accuracy at each process, and provides both a high quality I/P conversion algorithm and a highly accurate colour management system.

Nonlinear Cubic Conversion colour management

The nonlinear cubic conversion colour management system of BVM-E and BVM-F Series master monitors use a unique 3D LUT (look-up table) to accurately reproduce the colour gamuts of each broadcast standard such as ITU-R BT.709, EBU, and SMPTE-C phosphor standards. In addition, the OLED's wide colour gamut enables D-Cine emulation for digital intermediate work.*

* D-Cine is a colour gamut emulating the colour gamut described in SMPTE RP 431-2-2007. The chromaticity of the green-red region is not covered in full; however, the colour shift is subtle in this region. This feature is supported by the BVM-E Series only.

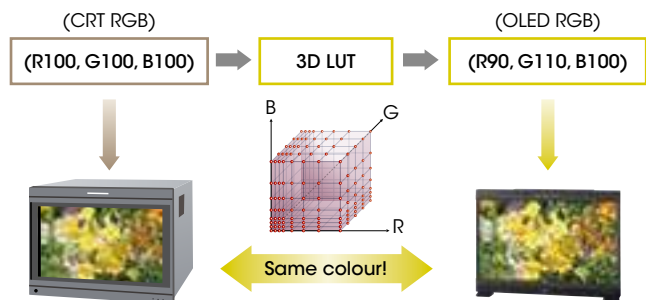

Nonlinear Cubic Conversion colour management system

Cutting-edge I/P conversion with low process delay

Sony's original I/P conversion technology used in the BVM Series minimizes processing artifacts in typical up-conversion processes. This has been improved in the BVM-E and BVM-F Series so that an interlaced image is displayed accurately and faithfully.

12-bit output accuracy signal processing

The BVM-E and BVM-F Series use a 12-bit display engine, which allows images to be reproduced with high precision for display accuracy.

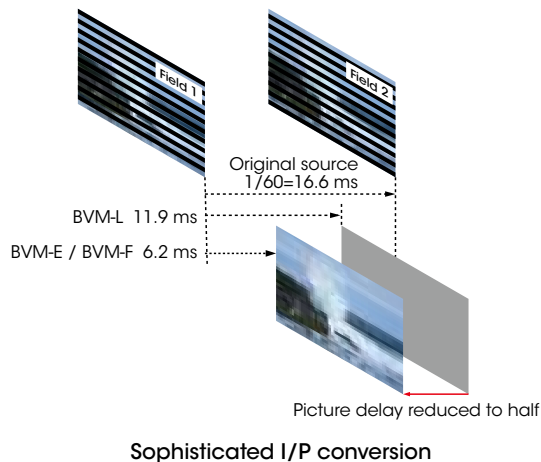
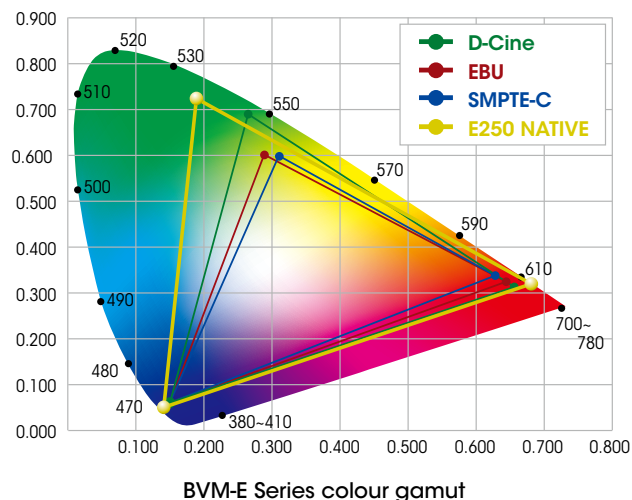

Sophisticated I/P conversion

BVM-E Series Digital Cinema Features

The BVM-E Series – comprising BVM-E250 and BVM-E170 master monitors – offers digital cinema features which are indispensable and ideal for high-quality creative digital cinema onset and post-production workflow.

2K (2048 x 1080, RGB/XYZ) Input

BVM-E250 and BVM-E170 master monitors are capable of 2K (2048 x 1080 resolution, RGB/XYZ) input. The 2K signal is displayed in two ways – as a full 2K image scaled into a full-HD (1920 x 1080) screen, or as a 2K native display with an image-slide function.

2048 Image-slide

The 2048 Image-slide function allows 2K resolution (2048 x 1080 pixels) images to be mapped, pixel-to-pixel, on the full-HD (1920 x 1080 pixels) panel without picture degradation. When the user needs to view the left or right edge of the picture frame, they can scroll the image in a horizontal direction.



S-LOG Gamma

S-LOG gamma is a technique used in Sony’s digital cinematography cameras that allows the full latitude of the camera CCD to be maintained throughout the production chain. Unlike conventional systems, in which highlight contrast is compressed, S-LOG Gamma logarithmically converts the video signal using characteristics similar to film negatives.

This keeps the camera CCD dynamic range intact, even in extreme highlight areas. Two display modes are offered:

1) S-LOG Full

This mode displays the full dynamic range of the video signal captured from Sony’s digital cinematography cameras.

2) S-LOG Standard

This mode displays image exposure levels at the lower part of the S-LOG gamma signal dynamic range, allowing image areas of regular brightness to be viewed clearly. Higher exposure levels are clipped in this mode.

Gamut Error Display

This function detects irregular signal input. When an irregular signal is detected, these master monitors indicate this with a zebra pattern over the relevant area of the picture.

Gamut Error Display is a convenient feature that instantly alerts viewers to such signals without requiring the use of a waveform monitor.



ASC CDL and User LUT Functions

BVM-E Series monitors support the ASC CDL (American Society of Cinematographers Colour Decision List) and User LUT (Look-up Table) to emulate colour grading.

Live images from camera onset can be altered after importing an ASC CDL format, and/or previewed using a film print emulation applied to the monitor using Look Creation Workflow.*1

Furthermore, once ASC CDL and User LUT data are created, all information*2 can be saved to Memory Stick™ media*3 and loaded onto the monitor from the BKM-16R controller. Up to five items of ASC CDL and User LUT data can be imported to BVM-E Series monitors, so users can easily compare different colour grading (see Look Application Workflow).

These features help with creative decision making and improve workflow between onset and post-production.

*1 Requires BVM-E firmware V1.1 or later, and third-party software supporting the BVM-E ASC CDL and User LUT functions.

*2 Up to 1,000 data items.

*3 Can use a Memory Stick, Memory Stick PRO™, Memory Stick Duo™, Memory Stick PRO Duo™, or (with optional adaptor) Memory Stick Micro™.

Look Creation Workflow



Look Applying Workflow

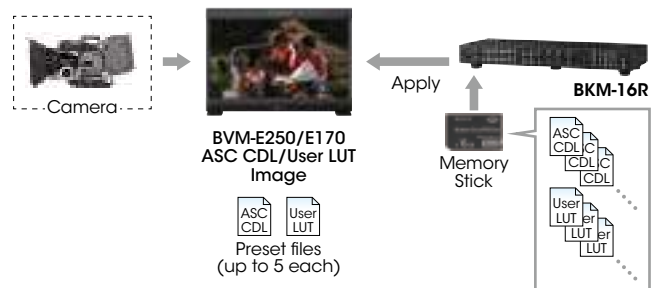

Live image from a camera



Onset graded image

BVM Advanced Features

Input Versatility

Multi-format signal support

BVM-E and BVM-F Series monitors support various input signals ranging from 720 x 576/50i to 1920 x 1080/50P, 60P, digital cinema (D-Cine) 2048 x 1080/24P*, and numerous computer signals up to 1920 x 1080.

* 2048 x 1080/p signals are supported by the BVM-E Series only.

Standard 3G-SDI inputs plus versatile optional ports

These monitors are equipped with two standard 3G/HD/SD-SDI inputs and an HDMI (HDCP correspondence) input. In addition, four option ports are available. This increases system versatility and allows users to add decoders for signal formats not supported by the supplied inputs, including extra 3G-SDI, HD-SDI, or SD-SDI, and Dual-link HD-SDI, RGB, Y/C_B/C_R, Y/C, and composite signal inputs.

DisplayPort*

These monitors are also equipped with a standard DisplayPort for future expansion.

* This will be supported by monitor firmware in V1.1 or later.

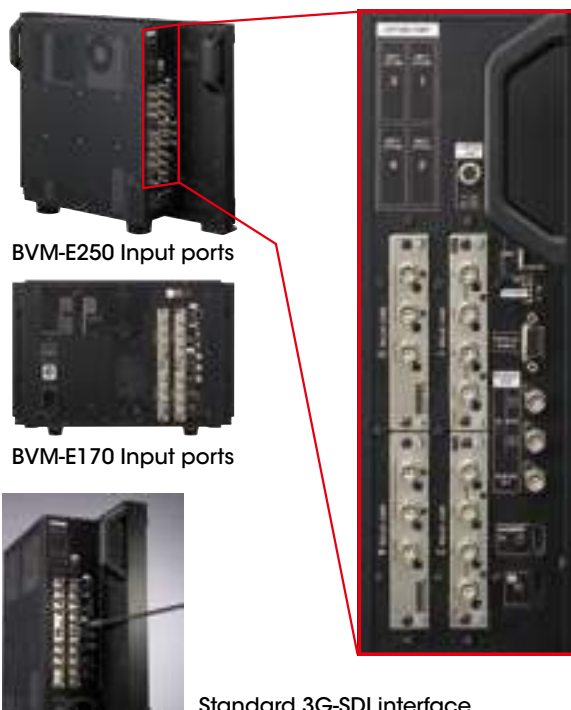

Signal-interface Options

BKM-250TG, 3G/HD/SD-SDI Input Adaptor*

- 3G/HD/SD-SDI signal input (x2)
- 3G/HD/SD-SDI monitor output (x2)

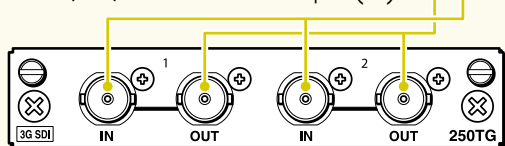

* 3G-SDI, HD-SDI and SD-SDI signals are detected automatically

BKM-244CC, HD/SD-SDI Closed Caption Adaptor*

- HD-SDI/SD-SDI signal input (x2)
- HD-SDI/SD-SDI monitor output (x1)

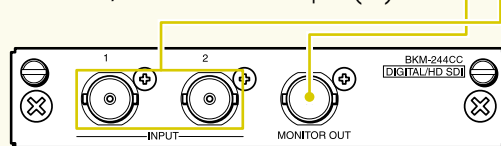

* HD-SDI and SD-SDI signals are detected automatically
* Closed-caption decoders (EIA 608 and EIA 708) are equipped

BKM-243HS, HD-SDI/SD-SDI Input Adaptor*

- HD-SDI/SD-SDI signal input (x2)
- HD-SDI/SD-SDI monitor output (x1)

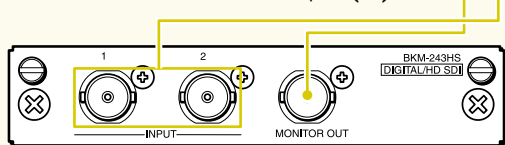

* HD-SDI and SD-SDI signals are detected automatically

BKM-229X, Analogue Component Adaptor

- RGB, Y/P_B/P_R input (x1)
- EXT SYNC (x1)

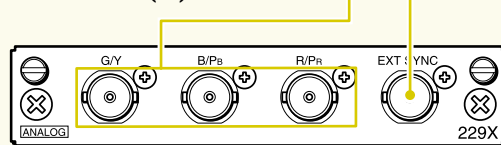

BKM-227W, NTSC/PAL Input Adaptor

- Composite input/output (x1)
- Y/C input/output (x1)

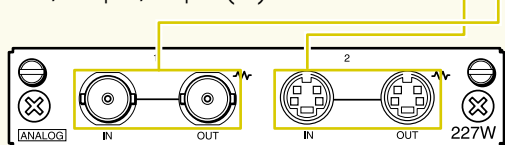

BKM-220D, SD-SDI 4:2:2 Input Adaptor

- SD-SDI signal input (x2)
- SD-SDI monitor output (x1)

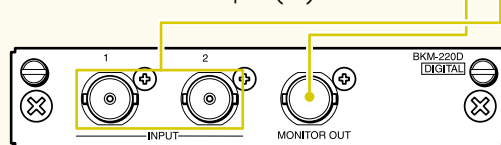

▲ Signal Analyzing Functions

Picture & Picture

The unique Picture & Picture function of the BVM-E and BVM-F Series allows simultaneous display of two input signals on the monitor's screen. This function is extremely convenient for making instant adjustments to two input sources, because there is no need to individually adjust the different characteristics of two monitors.

This function comes in handy for adjustments between two cameras, special-effects creation, time-lapse shooting, and computer graphics (CG) work. The BVM-E Series offers four Picture & Picture modes and the BVM-F Series offers side-by-side mode:

■ Side-by-side

The two picture images are downscaled using a digital filter and displayed side-by-side. This feature is convenient when making white balance adjustments or determining shooting angles between two cameras.

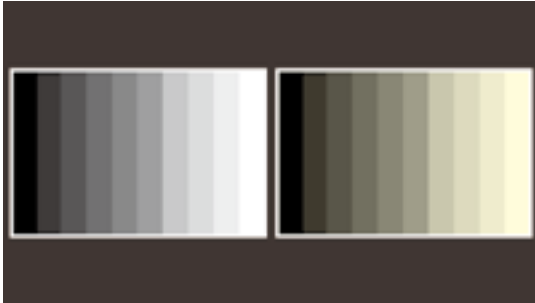

■ WIPE (BVM-E Series only)

The area of the two pictures to be displayed is selected using a vertical WIPE pattern, which is controlled from the BKM-16R. This function is useful when picture detail of the two images must be examined on a pixel basis. This is normally used to review still images.



■ Butterfly (BVM-E Series only)

The two inputs are displayed as line-symmetric images on the left and right halves of the screen. By adjusting the H-position controller, the two images can be moved inward to the middle of the screen. An instant comparison of the moving images can then be made easily and accurately, without the user having to move their eyes.



■ Blending (BVM-E Series only)

The two picture images are overlapped for display, and the mix ratio is adjustable. This function is useful to verify whether a foreground signal is accurately keyed into the background signal, or when combining shoots with live action and computer-generated effects.



Pixel Zoom

Pixel Zoom is a function for magnifying images. A selected area of the displayed picture can be enlarged on a pixel basis, up to eight times in size both vertically and horizontally. Because this function does not use scaling, the desired picture content is magnified and displayed faithfully to the raw input signal. This function is useful when evaluating precise picture edges, such as for chroma keying.

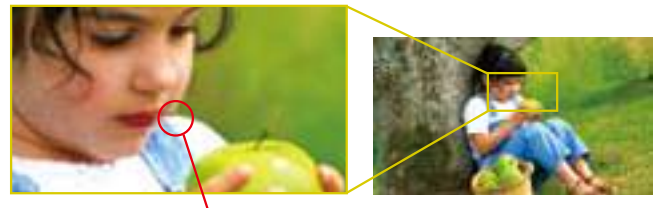

Error Signal

* This function is effective when the input signal is displayed in "Native Scan" mode.

▲ 3D Signal Analyzing Functions

By installing the optional BKM-250TG 3G/HD-SDI input adaptor*, the BVM-E and BVM-F Series monitors can support a variety of 3D signal analyses. The 3D signals are displayed in 2D mode.

* "Difference display" function require the BKM-250TG serial No. 7300001 or higher, and other functions require the BKM-250TG serial No. 7100001 or higher.

Difference Display

This function displays the difference between the luminance signal of the left (L) and right (R) images of the 3D signal. When the luminance levels of the two signals are the same, the signals are displayed in grey. When they are different, a monochrome image is displayed according to the variation in luminance. This function is useful for checking the amount of parallax.

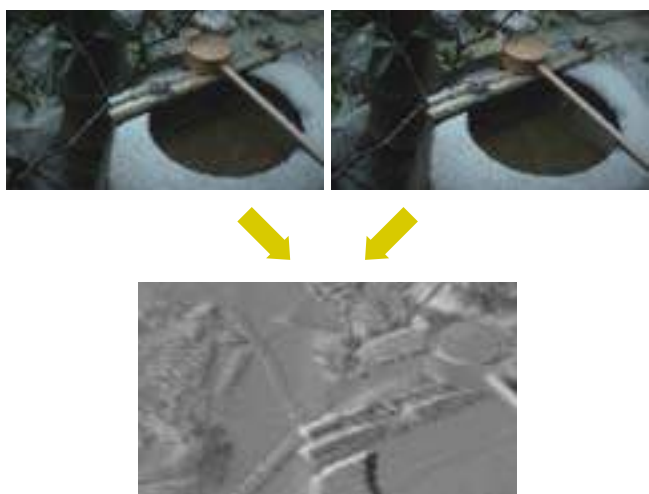

Checker Board

Left and right input signals are displayed in a grid pattern on screen. By comparing adjacent images, users can recognize a difference in brightness and the colour setting of the left and right images, and thus easily adjust the camera's white balance and iris settings.

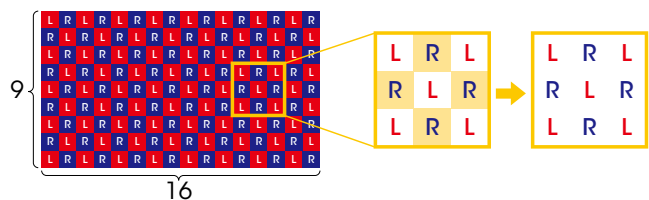

L/R Switch

Left and right signals can be swapped in a moment without inserting black frames, simply by manually pushing a function key. This instant-swap capability enables users to compare the entire images and check for any sense of incongruity or for unnatural images.

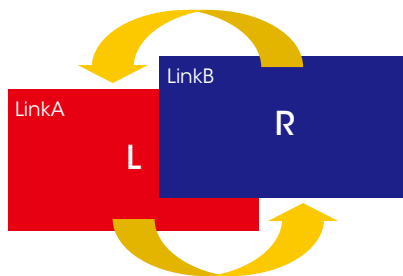

Horopter Check

This function helps users to perceive the subtle difference of depth between different objects placed on the 3D screen surface.

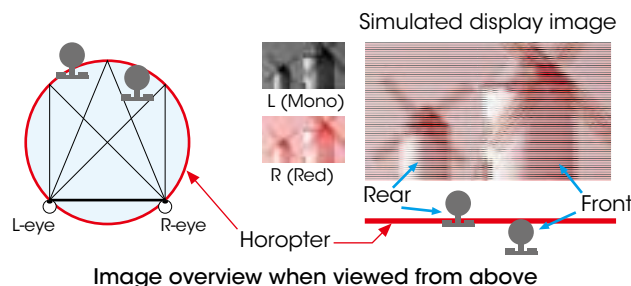

Horizontal Flip

When a half-mirror type of rig is used, either the left or right signal may be reversed horizontally. The Horizontal flip function turns the reversed image to the normal view.

* A delay in signal processing occurs, and both the left and right signals synchronize to the delayed signal.

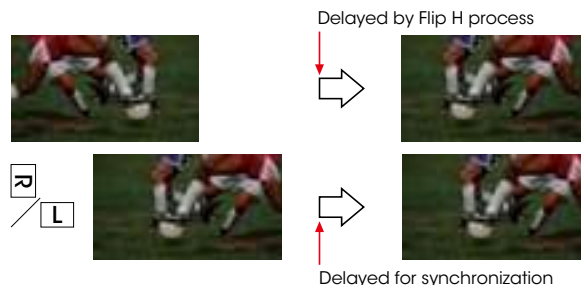

▲ Convenient Features

Interlace Display

BVM-E and BVM-F Series monitors offer an Interlace Display feature for 1080i and SD inputs. This lets each BVM-E and BVM-F monitor display these inputs as a true interlace display. As with the Native Scan function, Interlace Display mode offers faithful reproduction of the input signal, and the displayed interlace fields are free from the picture degradation that can occur as a result of typical I/P conversion processes.

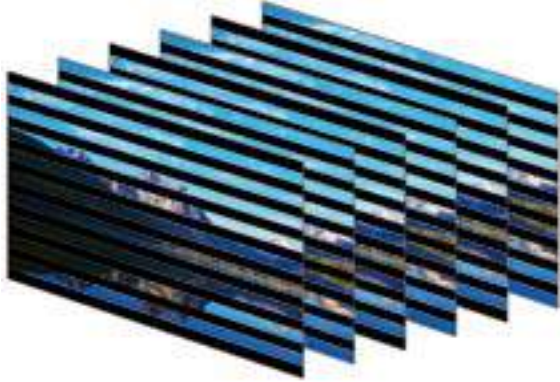

Scan Switch

The Scan Switch function allows switching between under scan (-3%), normal scan (0%), and over scan (mask of the 5% over scan portion in the normal scan).

Native Scan (pixel-to-pixel display)

Conventional flat-panel monitors reproduce images using scaling and I/P conversion due to their fixed pixel counts and progressive scanning processes. The Native Scan function is a unique display mode that reproduces images without changing the input signal's pixel count.

For example, when an SD signal is input, the BVM-E and BVM-F Series monitors will reproduce the image at a picture size of 720 x 487* pixels. For SD inputs the Native Scan function also allows the displayed image size to be doubled to 1440 x 974* by duplicating and doubling each pixel both horizontally and vertically.

* The 525/59.94i signal specified by Rec. ITU-R BT.601.

HD Frame Capture

The HD Frame Capture function of the BVM-E and BVM-F Series allow a picture frame from the 3G-SDI and HD-SDI input to be captured and saved as a picture file on Memory Stick media.* This picture file can be used as a reference for various purposes; for example, as for picture-tone adjustments between past images and for camera-framing adjustments.

* Memory Stick PRO (High-Speed) / Memory Stick PRO Duo (High-Speed) can be used.

Aspect Correction Mode

PAL and NTSC video systems are all based on rectangular pixels. Display of these formats on a square pixel panel typically distorts the image. The BVM-E and BVM-F Series use a unique process called Aspect Correction which, while still offering native pixel performance, continues to display image geometry correctly. This scaling technique used in BVM-E and BVM-F Series monitors corrects horizontal distortion while keeping the vertical pixel count correctly displayed.

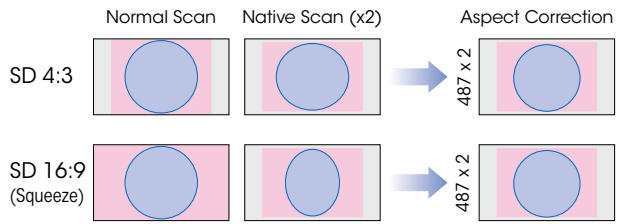

Example of NTSC signal on the 16:9 aspect panel – BVM-E250



720 x 487 Native Scan



1440 x 974 Native Scan (720 x 487) x 2

Aspect switch

The aspect ratio can be switched between 4:3, 16:9, 2.39:1, and 1.896:1 depending on the input signal.

16:9	↔	4:3
16:9	↔	2.39:1
1.896:1	↔	2.39:1

* The BVM-F Series monitors support 16:9 and 4:3 only.

Marker settings

BVM-E and BVM-F Series monitors can display various markers, including an aspect marker, safe area marker, and center marker. In addition to this flexible selection of marker types, detailed display settings of each marker are offered. For example, the colour, brightness, horizontal/vertical position, and width of aspect markers can all be controlled, while the height and width of safe area markers can be adjusted.

Marker Variation

	Safe Area Marker		Aspect Marker*
	%	Dot (Pixel)	
Selectable Markers	80%, 88%, 90%, 93%, or variable	Flexible	16:9, 15:9, 14:9, 13:9, 4:3, 2.39:1, 2.35:1, 1.896:1, 1.85:1, or 1.66:1
Line Colours	White, Red, Green, Blue, Yellow, Cyan, or Magenta		
Line Width	1 to 5 dots (factory preset at 2 dots)		
Line Luminance	High (bright) or Low (dark)		
Blanking	—		Off: Blanking is released Black: Blanking Half: Half blanking

* The BVM-F Series monitors support Aspect Markers of 16:9 and 4:3 only.

Marker Examples



Aspect Mode: 2.35:1,
Safe Area: Shape A,
Area Size: 80%



Aspect Mode: 14:9,
Safe Area: Shape B,
Area Size: 80%



Aspect Mode: 4:3,
Safe Area: Shape C,
Area Size: 80%

Wide Variety of Functions

The user has a wide variety of over 40 functions to choose from.

Each of these can be assigned to any of the 16 function buttons (F1 to F16) on the BKM-16R controller. Press ENTER to display the F1 to F8 (or F9 to F16) button assignment on screen.

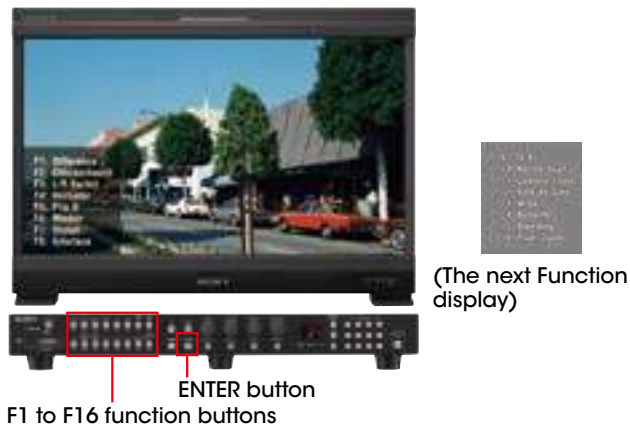

*Screen image is simulated

Status Display

Simply assign STATUS to one of the function buttons (F1 to F16) on the BKM-16R controller.

The user can instantly grasp the whole monitor status and configurations without having to search through menus.



*Screen image is simulated

▲ Modular Monitor Control Unit (BKM-16R)

BVM-E and BVM-F Series monitors and their control panels are provided as separate units, allowing greater flexibility for system integration. The BVM-E and BVM-F Series monitors incorporate a monitor control unit, the BKM-16R as an option. This BKM-16R control unit can be attached beneath the monitor using the optional controller attachment stand*, or connected remotely via an Ethernet cable.

* The BVM-E250 and BVM-F250 use the BKM-37H and BKM-38H Attachment Stands. The BVM-E170 and BVM-F170 use the BKM-39H Attachment Stand.



BVM-E250 monitor
BKM-16R monitor control unit
BKM-37H attachment Stand



BVM-E170 monitor
BKM-16R monitor control unit
BKM-39H attachment Stand



BVM-F250 monitor
BKM-16R monitor control unit
BKM-38H attachment Stand

Copy function for monitor setup and adjustment data

The optional BKM-16R control unit includes a Memory Stick slot*1 to save and load monitor configuration and adjustment settings. This is useful for multiple monitor systems, allowing the transfer of one monitor's setup and adjustment data to another.*2 This data can also be transferred via the BVM's Ethernet connection.

*1 Memory Stick, Memory Stick PRO, Memory Stick Duo, Memory Stick PRO Duo, and Memory Stick Micro (an optional adaptor is required) can be used.
*2 Data can be moved between BVM-E and BVM-F Series monitors.

"+12dB Chroma UP" function

A "Chroma UP" button located on the front panel of the BKM-16R allows the chroma level to be boosted by +12 dB. This is a convenient feature for adjusting camera white balance with a higher degree of accuracy.

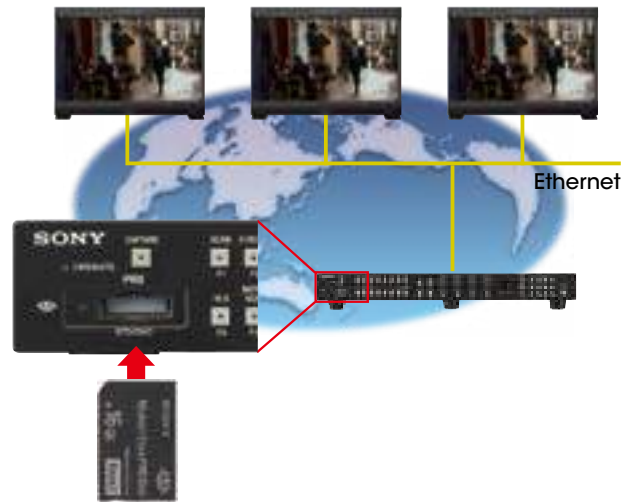

BKM-16R Monitor Control Unit



Front panel



Rear panel

Ethernet-based remote control

The BVM-E and BVM-F Series monitors and the BKM-16R Monitor Control Unit are equipped with an Ethernet port, allowing remote control of display parameters across a standard Ethernet connection. One BKM-16R Monitor Control Unit can control up to thirty-two (32) BVM* monitors.

* Includes BVM-A CRT monitors, BVM-L, PVM-L, and BVM-E/-F Series monitors.

▲ Easy Setup and Adjustment

Auto White Adjustment*1

The BVM-E and BVM-F Series monitors employ a software-based colour temperature (white balance) calibration function, which is called "Monitor_AutoWhiteAdjustment". Combined with a PC and commercially available calibration tools*2, this function enables simple adjustment of the monitor's white balance.

*1 Supported with version 1.1 or later.

*2 Konica Minolta CA-210, CA-310, CS-200, DK-Technologies PM5639/06, X-Rite i1 (Eye-One) Pro, Photo Research PR-670, Klein K-10, and JETI specbos 1211. A connector is required for each colour analyzer.



"Monitor_AutoWhiteAdjustment" GUI image

Built-in Colour Sensor for Auto White Adjustment

The BVM-E170 and BVM-F170 are equipped with a built-in colour sensor, which allows the user to calibrate the monitor's colour temperature (white balance) as needed without an external probe. Calibration performance is minimally affected by ambient light.

This function ensures colour and gamma consistency, and reduces user maintenance tasks.



"Character Off" button

To facilitate parameter adjustments, the On-Screen Menu indication can be taken off the screen, while in Menu mode. The On-Screen Menu indication can be toggled on or off with a simple press of a button on the BKM-16R's front panel.

Auto Chroma / Phase adjustment*

An Auto Chroma / Phase / Matrix setup function is provided on BVM-E and BVM-F Series monitors, which automatically adjusts the monitor's chroma, phase, and matrix using external colour bars.

* Supports analogue signal inputs only.

DC operation

The BVM-E170 and BVM-F170 can be DC operated. Due to their lightweight and small-size design, with a comparable height to the former 14-inch BVM-CRT monitors, the BVM-E170 and BVM-F170 are ideal for field and OB van applications.

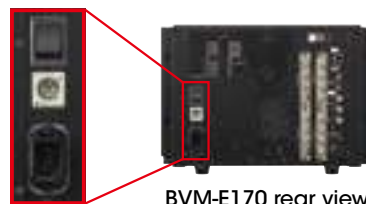

BVM-E170 rear view

Tilt stand for BVM-E250 / F250



BVM-E250 with the optional BKM-37H tilt stand

▲ Other features

- VESA™ Mounting (200 x 100 mm pitch)*1
- EIA 19-inch Standard Rack-mountable*2
- Blue Only
- Mono
- H Delay / V Delay
- NTSC Setup Level (0%, 7.5%)
- Component Level (SMPTE / EBU-N10 or Betacam)
- Aperture
- Serial Remote (Ethernet)
- Parallel Remote (D-sub 9-pin)
- Tally Lamp (Amber)
- EXT Sync (for RGB / YUV)
- Remote Maintenance

*1 BVM-E250 / BVM-F250 only.

*2 BVM-E170 / BVM-F170 only. Mounting brackets are supplied.

OLED Picture Monitor

For Critical Picture Viewing



PVM-2541



PVM-1741



PVM-740

The PVM-2541 and PVM-1741 as well as the PVM-740 are all-in-one OLED picture monitors, delivering unparalleled picture quality with the performance features and functions found in more expensive monitors, all contained in a compact, stylish design.

- Sony's Super Top Emission OLED display panel with 10-bit RGB:
 - 24.5-inch*¹ and 16.5-inch*¹ (Full HD 1920 x 1080 pixels)
 - 7.4-inch*¹ (Quarter HD 960 x 540 pixels)
- Wide dynamic range display
- New compact metal chassis
 - Lightweight and robust metal body
- Standard inputs
 - 3G/HD/SD-SDI input (x2)*², HDMI (HDCP) (x1), and Composite (x1)
- Built-in analyzers
 - Waveform monitor, audio level meter, timecode*³
- Easy-to-use control panel
 - Rotary-type switch for quick menu access
 - Seven function-assignable buttons for direct and quick access
- DC 12V operations (PVM-1741 and PVM-740)
- Auto white adjustment with PC application software
- External remote control function (parallel and serial remote)

*¹ 623.4 mm, 419.7 mm, and 188.0 mm (respectively), measured diagonally.

*² The PVM-740 is equipped with one SDI input connector.

*³ The PVM-740 does not support timecode display.

Groundbreaking Picture Performance with Sony's OLED Technologies

Sony's 24.5-inch, 16.5-inch, and 7.4-inch Super Top Emission OLED display panels provide unparalleled black performance, a wide colour gamut, and quick pixel response with virtually no motion blur.

By combining Sony's OLED display panel (Full HD*¹, 10-bit driver) and Sony's OLED processing technologies*², the PVM Series of OLED monitors deliver exceptional picture quality never before seen in conventional picture monitors.

*1 The PVM-740 delivers Quarter HD (960 x 540) resolution.

*2 The PVM-740 is equipped with the ChromaTRU processing technology.

Main Features

▲ Sony's OLED with Full HD* and 10-bit RGB

The PVM-2541 and PVM-1741 OLED panel with Full HD resolution (1920 x 1080) and a 10-bit RGB driver, together with Sony's Super Top Emission OLED display panel, creates lifelike and smoother-than-ever gradation from dark to bright portions of a scene such as in a sunrise or sunset.

* The PVM-740 delivers Quarter HD (960 x 540) resolution.

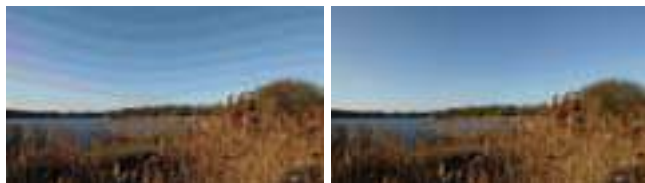

8-bit (256-levels) image*

10-bit (1024-levels) image*

* Simulated images

▲ Superb Black Performance

Thanks to Sony's OLED system, deep blacks can be accurately displayed and the black portion of an image is not degraded.



Black performance image

* Simulated image

▲ Wide Colour Gamut and High-purity Deep Colour Reproduction

Sony's OLED technology shows the largest colour range of any Sony monitor ever offered. Colour standards such as ITU-R BT.709, EBU, and SMPTE-C are displayed more accurately and, if desired, the OLED panel's native colour gamut can be displayed. Sony's micro-cavity structure uses an optical resonance effect in combination with accurate colour filters to calibrate and stabilize RGB colour accuracy. This combination is also effective in reducing ambient light reflection, and consequently deep colour reproduction can be achieved without degradation, particularly in bright environments.

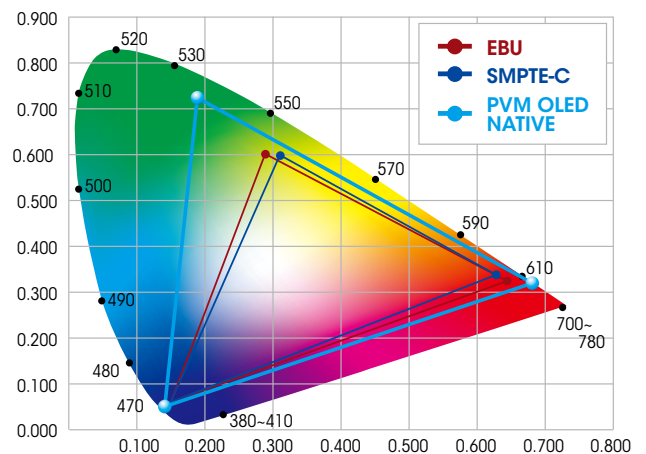

PVM Series OLED monitors colour gamut

▲ Quick Response with Blur-free Motion

Because the OLED electroluminescent layer inherently responds to any electrical current input, it emits light immediately. By this mechanism, excellent quick response characteristics can be achieved on fast-motion images. This efficient blur-free, fast response benefits a variety of applications and scenes, e.g., in sports broadcasting, monitoring of camera panning, and text scrolling.



▲ Superb Uniformity

The PVM-2541 and PVM-1741 monitors incorporate a newly developed OLED process to bring out the full performances of the Sony's OLED panels. This OLED processor offers superb uniformity across all signal levels at every point of the screen. At the factory, the OLED panel uniformity is precisely measured and corrected using a sophisticated RGB LUT (look-up table) adjustment system.

▲ I/P Mode Selection

The PVM-2541 and PVM-1741 monitors provide four I/P modes so that users can select the most suitable mode for each purpose:

- **INTER-FIELD:**
This mode interpolates images between fields. This is used for picture quality precedence (e.g., to reduce the jagged effect on moving pictures).
- **INTRA-FIELD:**
This mode interpolates images within the field, and delivers naturally reproduced images and quick picture processing. This mode is available only for 1920 x 1080 SDI signal input.
- **FIELD MERGE:**
This mode combines lines alternately in odd and even fields, regardless of picture movements. This is used for PsF (Progressive Segmented Frame) processing and still image monitoring.
- **LINE DOUBLER:**
This mode interpolates by repeating each line. This is used for editing and monitoring fast-moving images, and checking line flicker. The minimum processing time is less than one field (0.5 frames).

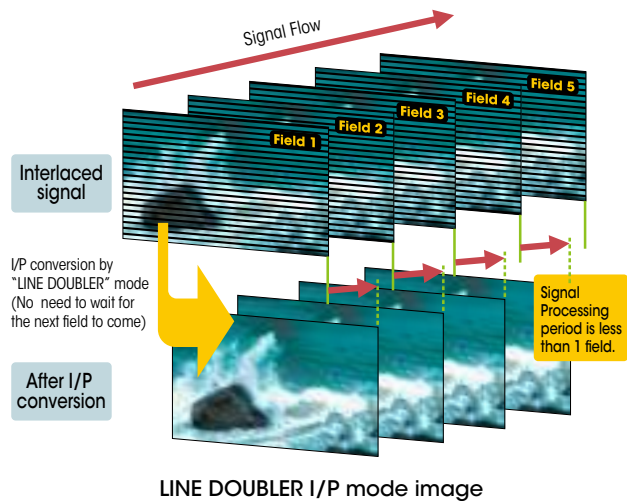

▲ Lightweight Compact Design - Flexible Mounting For Picture Monitoring

The PVM-2541 and PVM-1741 incorporate a lightweight, compact metal body. Their design offers flexibility, and can be adapted according to the application: a desktop unit with standard table feet, or used with an optional SU-561 stand, or without the stand for wall applications.

These monitors support VESA mounting with a 100 mm pitch, and EIA 19-inch standard racks.* This allows the monitors to be used for all types of application - desktop editing, office viewing, on a studio monitor wall, or installed in OB vans.

* The PVM-1741 only is available with standard rack-mount brackets.



PVM-2541 front



PVM-2541 rear



PVM-2541 side



PVM-1741 front



PVM-1741 rear



PVM-1741 side



PVM-2541 standard



PVM-2541 with optional SU-561



PVM-2541 without stand

▲ Easy-to-use Control Panel

A rotary-type switch and seven function-assignable buttons allow users quick and intuitive operation. Operation buttons with LED indicators enable error-free operation, even in dark environments.*

* LED lights can be switched on/off.



Control panel with LED lights-on

▲ Input Versatility

The PVM-2541 and PVM-1741 monitors are equipped with built-in standard input interfaces: 3G/HD/SD-SDI (x2), HDMI (HDCP) input (x1) and composite (x1).

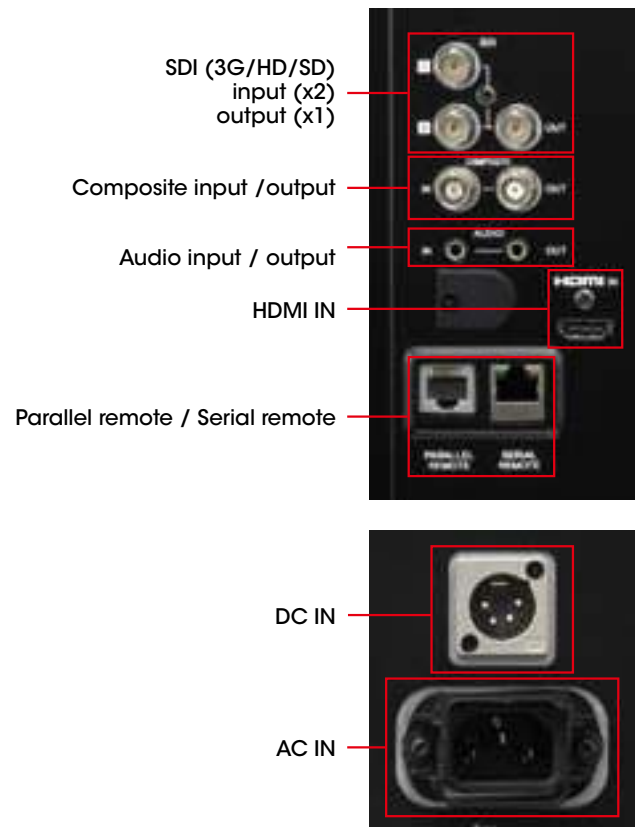

▲▲ Waveform Monitor, Audio Level Meter, and Time Code Display

Input signal waveform with a 2-channel audio level meter can be displayed on screen. When an SDI interface is connected, the embedded audio level can be displayed on screen with an 8-channel audio level meter. Time code embedded on SDI signals can be displayed on screen. Users can select either LTC or VITC.

* The Audio Level Meter function works only when receiving SDI-embedded audio signals.



The waveform monitor, 2-channel audio level meter, and time code display*

The 8-channel audio level meter*

* Simulated images

▲▲ Auto White Adjustment

The PVM-2541 and PVM-1741 as well as PVM-740 monitors employ a software-based colour temperature (white balance) calibration function, which is called "Monitor_AutoWhiteAdjustment". Combined with a PC and commercially available calibration tools*, this function enables simple adjustment of the monitor's white balance.

* The Konica Minolta CA-210/CA-310/CS-200, DK-Technologies PM5639/06, X-Rite i1 (Eye-one) Pro, Photo Research PR-670, Klein K-10, and JETI specbos 1211.



"Monitor_AutoWhiteAdjustment" GUI image

▲▲ PVM-2541 / PVM-1741 DVI Input Signals

Resolution	Dot clock (MHz)	fH (kHz)	fV (Hz)
640 x 480	25.175	31.5	60
1280 x 768	68.250	47.4	
1280 x 1024	108.000	64.0	
1360 x 768	85.500	47.7	
1440 x 900	88.750	55.5	
1680 x 1050	119.000	64.7	

- When a DVI signal is input to the HDMI IN connector using a DVI conversion cable.
- Sides of the displayed picture may be hidden depending on the input signal.



PVM-740

*Simulated image



7.4-inch OLED panel

▲ OLED Portable Picture Monitor – PVM-740

The PVM-740 is a portable monitor in the PVM Series of OLED monitors. It packs high performance and a variety of features and functions in its robust and compact body.

- Sony's Super Top Emission OLED panel with a 10-bit driver
- Deep black and high contrast, high-purity deep colour reproduction, and quick response with virtually no motion blur
- Wide colour gamut and accurate gamma supporting broadcast standards (SMPTE-C, EBU, and ITU-R BT.709)
- Audio level meter and waveform monitor
- Screen saver function
- Silent mode
- External remote function

Robust, light-weight, and compact body

Incorporating a light-weight and compact aluminium-diecast body with a detachable AR-coated protection panel, this model is flexible enough to change style according to user requirements: with or without stand (which is easily detachable), tilted on a stand (15-degree slant), rack-mounted, or set on a camera pedestal.



PVM-740 with supplied stand tilt (15°)



PVM-740 without stand



PVM-740 installed in the optional MB-531 19" mounting bracket with MB-532 mounting panel

Camera focus function

The PVM-740 can control and increase the aperture level of a video signal, and display images on the screen with sharpened edges to help camera focus operation. This camera focus function can even be enhanced when combined with native scan mode.



Flip function

The PVM-740 monitor has a feature to flip a picture without frame delay, horizontally, vertically, or horizontally and vertically. This feature is useful and beneficial - for example, when using a 3D image acquisition system with a 3D rig camera. This allows for much simpler system integration and greater cost efficiency.

Screw holes for camera pedestal

With 3/8-inch and 1/4-inch screw holes on its base, the PVM-740 can be installed in a camera pedestal.

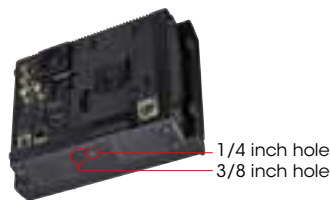

PVM-740 rear and bottom

Detachable AR (anti-reflection) -coated protection panel

AR-coated protection panel keeps the OLED panel surface from scratch and keeps reflection from ambient light to a minimum.



ENG Kit VF-510

For use in ENG and EFP field, the optional VF-510 ENG Kit provides a viewing hood, carrying handle, and connector protector.



PVM-740 with VF-510 ENG Kit

Input versatility

The PVM-740 is equipped with built-in standard input interfaces: 3G/HD/SD-SDI (x1), composite (x1), and HDMI input (x1).

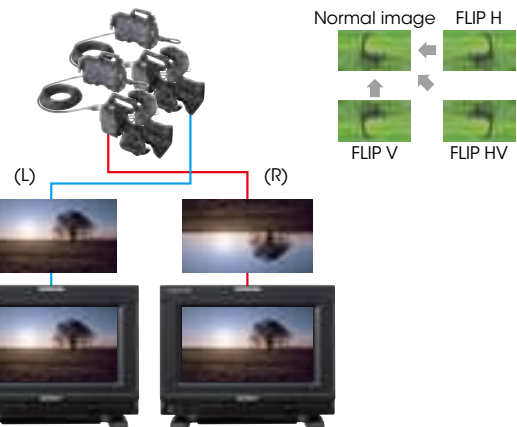

BVM-E / BVM-F Series Signal Formats / Input Adaptors

Input signal	Signal system	Signal format	Standard SDI Input	BKM-220D	BKM-227W	BKM-229X	BKM-243HS BKM-244CC	BKM-250TG	
Analogue composite	487/59.94i	NTSC				○			
	576/50i	PAL/SECAM				○			
	487/59.94i	PAL-M				○			
Analogue Y/C	487/59.94i	NTSC				○			
	576/50i	PAL/SECAM				○			
	487/59.94i	PAL-M				○			
Analogue component, RGB	1080/60i*1	Y/Pb/Pr, RGB					○		
	1080/50i						○		
	1080/24PsF*1						○		
	1080/25PsF						○		
	1080/30PsF*1						○		
	1080/24p*1						○		
	1080/25p						○		
	1080/30p*1						○		
	720/60p*1						○		
	720/50p						○		
	576/50i						○		
	487/59.94i						○		
	SD-SDI		720 x 487/59.94i	4:2:2 Y/Cb/Cr	○	○			○
720 x 576/50i		○	○			○	○		
HD-SDI	1920 x 1080/24PsF*1	10 bit 4:2:2 Y/Cb/Cr	○				○	○	
	1920 x 1080/25PsF		○			○	○		
	1920 x 1080/30PsF*1		○				○	○	
	1920 x 1080/24p*1		○				○	○	
	1920 x 1080/25p		○				○	○	
	1920 x 1080/30p*1		○				○	○	
	1920 x 1080/50i		○				○	○	
	1920 x 1080/60i*1		○				○	○	
	1280 x 720/24p*1		○				○	○	
	1280 x 720/25p		○				○	○	
	1280 x 720/30p*1		○				○	○	
	1280 x 720/50p		○				○	○	
	1280 x 720/60p*1		○				○	○	
HD-SDI dual-link	1920 x 1080/24PsF*1	10 bit 4:4:4 Y/Cb/Cr, RGB 12 bit 4:4:4 Y/Cb/Cr, RGB					○*2	○	
	1920 x 1080/25PsF						○*2	○	
	1920 x 1080/30PsF*1						○*2	○	
	1920 x 1080/24p*1						○*2	○	
	1920 x 1080/25p						○*2	○	
	1920 x 1080/30p*1						○*2	○	
	1920 x 1080/50i					○*2	○		
	1920 x 1080/60i*1					○*2	○		
	1920 x 1080/50p	10 bit 4:2:2 Y/Cb/Cr					○*2	○	
	1920 x 1080/60p*1						○*2	○	
	2048 x 1080/24PsF*1*3		10 bit/12 bit 4:4:4 RGB 12 bit 4:4:4 XYZ					○*2	○
	2048 x 1080/24p*1*3							○*2	○
	2048 x 1080/25PsF*3							○*2	○
2048 x 1080/25p*3							○*2	○	
2048 x 1080/30PsF*1*3							○*2	○	
2048 x 1080/30p*1*3					○*2	○			
3G-SDI	1920 x 1080/24PsF*1	10 bit 4:4:4 Y/Cb/Cr, RGB 12 bit 4:4:4 Y/Cb/Cr, RGB	○*4					○*4	
	1920 x 1080/25PsF		○*4				○*4		
	1920 x 1080/30PsF*1		○*4				○*4		
	1920 x 1080/24p*1		○*4				○*4		
	1920 x 1080/25p		○*4				○*4		
	1920 x 1080/30p*1		○*4				○*4		
	1920 x 1080/50i		○*4				○*4		
	1920 x 1080/60i*1		○*4				○*4		
	1920 x 1080/50p	10 bit 4:2:2 Y/Cb/Cr	○					○	
	1920 x 1080/60p*1		○					○	
	1280 x 720/24p*1		10 bit 4:4:4 Y/Cb/Cr, RGB	○*4					○*4
	1280 x 720/25p			○*4					○*4
	1280 x 720/30p*1			○*4					○*4
	1280 x 720/50p			○*4					○*4
	1280 x 720/60p*1			○*4					○*4
	2048 x 1080/24PsF*1*3		10 bit/12 bit 4:4:4 RGB 12 bit 4:4:4 XYZ	○*4					○*4
	2048 x 1080/24p*1*3			○*4					○*4
2048 x 1080/25PsF*3	○*4						○*4		
2048 x 1080/25p*3	○*4						○*4		
2048 x 1080/30PsF*1*3	○*4						○*4		
2048 x 1080/30p*1*3	○*4					○*4			

*1 Also compatible with 1/1.001 frame rates. *2 Two BKM-243HS or BKM-244CC are used.
*3 Supported with the BVM-E250 and BVM-E170 only. *4 Untested.

BVM-E / BVM-F Series HDMI Input Signal Formats

System	Interface sampling freq (MHz)	Aspect Ratio	Standard	HDMI
				RGB 4:4:4 8/10/12 bit Y/C _B /C _R 4:4:4 8/10/12 bit Y/C _B /C _R 4:2:2 12 bit
Video Signals				
640 x 480/60p*	25.200*	4:3	CEA-861	○
720 x 480/60p*	27.027*	4:3/16:9		○
1280 x 720/60p*	74.250*	16:9		○
1920 x 1080/60i*	74.250*	16:9	CEA-861	○
		2.39:1		
720 (1440) x 480/60i*	27.027*	4:3/16:9	CEA-861	○
720 x 576/50p	27.000*	4:3/16:9		○
1280 x 720/50p	74.250	16:9		○
1920 x 1080/50i	74.250	16:9	CEA-861	○
		2.39:1		
720 (1440) x 576/50i	27.000	4:3/16:9	CEA-861	○
1920 x 1080/60p*	148.500*	16:9	CEA-861	○
		2.39:1		
1920 x 1080/50p	148.500	16:9	CEA-861	○
		2.39:1		
1920 x 1080/24p*	74.250*	16:9	CEA-861	○
		2.39:1		
1920 x 1080/25p	74.250	16:9	CEA-861	○
		2.39:1		
1920 x 1080/30p*	74.250*	16:9	CEA-861	○
		2.39:1		
Computer Signals				
800 x 600/60p	40.000	4:3	VESA	○
1024 x 768/60p	65.000	4:3		○
1280 x 960/60p	108.000	4:3		○
1280 x 1024/60p	108.000	5:4		○
1400 x 1050/60p	121.750	4:3		○
fH: 28-75 kHz, fV: 48-85 Hz Max. res.: 1920 x 1080/60p	25.000-162.000			

* Also compatible with 1/1.001 frame rates.

PVM-2541 / PVM-1741 / PVM-740 Signal Formats

System	Signal standard			
	Analogue composite	SDI (3G/HD/SD)		HDMI
		PVM-2541 / PVM-1741	PVM-740	
575/50i (PAL)	○	○	○	○
480/60i (NTSC)*1	○	○	○	○
576/50p	-	-	-	○
480/60p*1	-	-	-	○
640 x 480/60p*1	-	-	-	○
1080/24PsF*1*2	-	○*3	○	-
1080/25PsF*2	-	○*3	○	-
1080/30PsF*1*2	-	○*3	-	-
1080/24p*1	-	○*3	○	○
1080/25p	-	○*3	○	○
1080/30p*1	-	○*3	○	○
1080/50i	-	○*3	○	○
1080/60i*1	-	○*3	○	○
1080/50p	-	○*4	○*4	○*6
1080/60p*1	-	○*4	○*4	○*6
720/24p*1	-	○*5	-	-
720/25p	-	○*5	-	-
720/30p*1	-	○*5	-	-
720/50p	-	○*3	○	○*6
720/60p*1	-	○*3	○	○*6

*1 Compatible with 1/1.001 frame rates.

*2 1080/24PsF, 25PsF, and 30PsF are displayed as 1080/48i, 50i, and 60i on the screen, respectively.

*3 10-bit 4:4:4 Y/C_B/C_R and 4:4:4 RGB of 3G-SDI signals are supported.

*4 10-bit 4:2:2 Y/C_B/C_R of 3G-SDI signal is supported.

*5 10-bit 4:4:4 Y/C_B/C_R of 3G-SDI signal is supported.

*6 PVM-2541 and PVM-1741 can accept DVI signals via the HDMI interface using a conversion cable.

Specifications

BVM-E Series



BVM-E250



BVM-E170

Picture Performance		
Panel	OLED panel	
Picture size (diagonal)	623.4 mm 24 5/8 inches	419.7 mm 16 1/2 inches
Effective picture size (H x V)	543.4 x 305.6 mm 21 1/2 x 12 1/8 inches	365.8 x 205.7 mm 14 1/2 x 8 1/8 inches
Resolution (H x V)	1920 x 1080 pixels (Full HD)	
Aspect	16:9	
Pixel efficiency	99.99%	
Panel drive	RGB 10-bit	
Panel frame rate	48 Hz / 50 Hz / 60 Hz / 72 Hz / 75 Hz (48 Hz, 60 Hz, and 72 Hz are also compatible with 1/1.001 frame rates)	
Viewing angle (panel specification)	89°/89°/89°/89° (typical) (up/down/left/right contrast > 10:1)	
Colour temperature	D55, D61, D65, D93, D-Cine, and user	
Standard luminance	100 cd/m ² (preset1 to preset5) 48 cd/m ² (preset (D-Cine)) (100% white signal input)	
Colour space (colour gamut)	ITU-R BT.709, EBU, SMPTE-C, D-Cine*1, E250 / E170 Native*2, S-GAMUT*3 The BVM-E250 / BVM-E170 individual chromaticity points: R (x = 0.681, y = 0.319) / G (x = 0.189, y = 0.724) / B (x = 0.141, y = 0.051) (typical)	
Input		
SDI	BNC (x2)	
HDMI	HDMI (x1) (HDCP correspondence, Deep Colour correspondence)	
DisplayPort	DisplayPort connector (x1)*4	
Option port	4 ports	
Parallel remote	D-sub 9-pin (female) (x1)	
Serial remote (LAN)	Ethernet (10BASE-T/100BASE-TX), RJ-45 (x1)	
Output		
SDI	BNC (x1)	
DC 5 V out	Circle 4-pin (female) (x1)	
General		
Power requirement	AC 100 V to 240 V, 1.6 A to 0.8 A, 50/60 Hz	AC 100 V to 240 V, 1.2 A to 0.7 A, 50/60 Hz DC 24 V to 28 V, 4.5 A to 3.9 A
Power consumption	Approx. 145 W (max.) Approx. 72 W (average power consumption in the default status)	Approx. 110 W (AC), 100 W (DC) (max.) Approx. 60 W (AC), 60 W (DC) (average power consumption in the default status)
Operating temperature	0°C to 35°C (32°F to 95°F) Recommended: 20°C to 30°C (68°F to 86°F)	
Operating humidity	0% to 90% (no condensation)	
Storage and transport temperature	-20°C to +60°C (-4°F to +140°F)	
Storage and transport humidity	0% to 90%	
Operating, storage, and transport pressure	700 hPa to 1060 hPa	
Dimensions (W x H x D)	576.0 x 424.0 x 148.0 mm 22 3/4 x 16 3/4 x 5 7/8 inches	436.0 x 282.4 (266.4)*5 x 214.7 mm 17 1/4 x 11 1/4 (10 1/2)*5 x 8 1/2 inches
Mass	13.0 kg 28 lb 11 oz	8.6 kg 18 lb 15 oz
Supplied accessories	AC power cord (1), AC plug holder (1), Bracket (1), Operation Manual (Japanese, English, each 1), CD-ROM (1), Using the CD-ROM Manual (1)	AC power cord (1), AC plug holder (1), Rack mount bracket (left, right, each 1), Rack mount attachment screws (4), Operation Manual (Japanese, English, each 1), CD-ROM (1), Using the CD-ROM Manual (1)

*1 Chromaticity point of SMPTE RP431-2 is not covered in full.

*2 The widest colour space setting of the signal reproduced by the BVM-E250 and BVM-E170.

*3 S-GAMUT is available for displaying the colour gamut of the wide colour space mode S-GAMUT, which is offered with the F23 and F35 Digital cinematography cameras.

*4 DisplayPort will be supported from the monitor firmware version 1.1 or later.

*5 Height without legs.

BVM-F Series



BVM-F250



BVM-F170

Picture Performance		
Panel	OLED panel	
Picture size (diagonal)	623.4 mm 24 5/8 inches	419.7 mm 16 1/2 inches
Effective picture size (H x V)	543.4 x 305.6 mm 21 1/2 x 12 1/8 inches	365.8 x 205.7 mm 14 1/2 x 8 1/8 inches
Resolution (H x V)	1920 x 1080 pixels (Full HD)	
Aspect	16:9	
Pixel efficiency	99.99%	
Panel drive	RGB 10-bit	
Panel frame rate	48 Hz / 50 Hz / 60 Hz / 72 Hz / 75 Hz (48 Hz, 60 Hz, and 72 Hz are also compatible with 1/1.001 frame rates)	
Viewing angle (panel specification)	89°/89°/89°/89° (typical) (up/down/left/right contrast > 10:1)	
Colour temperature	D65, D93, and user	
Standard luminance	100 cd/m ² (Preset1 to Preset5) (100% white signal input)	
Colour space (colour gamut)	ITU-R BT.709, EBU, SMPTE-C, F250 / F170 Native*1 The BVM-F250 / BVM-F170 individual chromaticity points: R (x = 0.681, y = 0.319) / G (x = 0.189, y = 0.724) / B (x = 0.141, y = 0.051) (typical)	
Input		
SDI	BNC (x2)	
HDMI	HDMI (x1) (HDCP correspondence, Deep Colour correspondence)	
DisplayPort	DisplayPort connector (x1)*2	
Option port	4 ports	
Parallel remote	D-sub 9-pin (female) (x1)	
Serial remote (LAN)	Ethernet (10BASE-T/100BASE-TX), RJ-45 (x1)	
Output		
SDI	BNC (x1)	
DC 5 V out	Circle 4-pin (female) (x1)	
General		
Power requirement	AC 100 V to 240 V, 1.6 A to 0.8 A, 50/60 Hz	AC 100 V to 240 V, 1.2 A to 0.7 A, 50/60 Hz DC 24 V to 28 V, 4.5 A to 3.9 A
Power consumption	Approx. 145 W (max.) Approx. 72 W (average power consumption in the default status)	Approx. 110 W (AC), 100 W (DC) (max.) Approx. 60 W (AC), 60 W (DC) (average power consumption in the default status)
Operating temperature	0°C to 35°C (32°F to 95°F) Recommended: 20°C to 30°C (68°F to 86°F)	
Operating humidity	0% to 90% (no condensation)	
Storage and transport temperature	-20°C to +60°C (-4°F to +140°F)	
Storage and transport humidity	0% to 90%	
Operating, storage, and transport pressure	700 hPa to 1060 hPa	
Dimensions (W x H x D)	576.0 x 424.0 x 148.0 mm 22 3/4 x 16 3/4 x 5 7/8 inches	436.0 x 282.4 (266.4)*3 x 214.7 mm 17 1/4 x 11 1/4 (10 1/2)*3 x 8 1/2 inches
Mass	13.0 kg 28 lb 11 oz	8.6 kg 18 lb 15 oz
Supplied accessories	AC power cord (1), AC plug holder (1), Bracket (1), Operation Manual (Japanese, English, each 1), CD-ROM (1), Using the CD-ROM Manual (1)	AC power cord (1), AC plug holder (1), Rack mount bracket (left, right, each 1), Rack mount attachment screws (4), Operation Manual (Japanese, English, each 1), CD-ROM (1), Using the CD-ROM Manual (1)

*1 The widest colour space setting of the signal reproduced by the BVM-F250 and BVM-F170.

*2 DisplayPort will be supported from the monitor firmware version 1.1 or later.

*3 Height without legs.

PVM Series



PVM-2541



PVM-1741



PVM-740

Picture Performance			
Panel	OLED panel		
Picture size (diagonal)	623.4 mm 24 5/8 inches	419.7 mm 16 1/2 inches	188.0 mm 7 1/2 inches
Effective picture size (H x V)	543.4 x 305.6 mm 21 1/2 x 12 1/8 inches	365.8 x 205.7 mm 14 1/2 x 8 1/8 inches	163.9 x 92.2 mm 6 1/2 x 3 5/8 inches
Resolution (H x V)	1920 x 1080 pixels (Full HD)		960 x 540 pixels (QHD)
Aspect	16:9		
Panel drive	RGB 10-bit		
Viewing angle (panel specification)	89°/89°/89°/89° (typical) (up/down/left/right contrast > 10:1)		
Input			
Composite	BNC (x1), 1.0 Vp-p ±3 dB sync negative		
SDI	BNC (x2)		BNC (x1)
HDMI	HDMI (x1) (HDCP correspondence)		
Audio	Stereo mini jack (x1), -5 dBu 47 kilohms or higher		
Parallel remote	Modular connector 8-pin (x1) (pin-assignable)		
Serial remote (LAN)	RJ-45 modular connector (Ethernet) (x1) (10BASE-T/100BASE-TX)		
DC IN connector	-	XLR-type 4-pin (male) (x1), 12 V DC (output impedance 0.05 ohms or less)	
Output			
Composite	BNC (x1), loop-through, with 75 ohms automatic termination		
SDI	BNC (x1), output signal amplitude: 800 mVp-p ±10%, output impedance: 75 ohms unbalanced		
Audio monitor out	Stereo mini jack (x1)		
Speaker (Built-in)	1.0 W (mono)		0.5 W (mono)
Headphones output	Stereo mini jack (x1)		
General			
Power requirement	AC 100 V to 240 V, 50/60 Hz, 1.4 A to 0.6 A	AC 100 V to 240 V, 50/60 Hz, 1.0 A to 0.5 A, DC 12 V, 7.0 A	AC 100 V to 240 V, 50/60 Hz, 0.5 A to 0.3 A, DC 12 V, 1.9 A
Power consumption	Approx. 130 W (max.) Approx. 88 W (average power consumption in the default status)	Approx. 90 W (AC power supply) (max.) Approx. 70 W (AC power supply) (average power consumption in the default status)	Approx. 27 W (max.)
Operating temperature	0°C to 35°C (32°F to 95°F) Recommended: 20°C to 30°C (68°F to 86°F)		0°C to 40°C (32°F to 104°F) Recommended: 20°C to 30°C (68°F to 86°F)
Operating humidity	30% to 85% (no condensation)		
Storage and transport temperature	-20°C to +60°C (-4°F to +140°F)		
Storage and transport humidity	0% to 90%		
Operating, storage, and transport pressure	700 hPa to 1060 hPa		
Dimensions (W x H x D) (with stand)	576.0 x 424.8 x 171.4 mm 22 3/4 x 16 3/4 x 6 3/4 inches	436.0 x 305.6 x 161.0 mm 17 1/4 x 12 1/8 x 6 3/8 inches	222.4 x 183.5 x 161.8 mm 8 7/8 x 7 1/4 x 6 3/8 inches (when AC adaptor is attached)
Dimensions (W x H x D) (without stand)	576.0 x 408.8 x 110.0 mm 22 3/4 x 16 1/8 x 4 3/8 inches	436.0 x 289.6 x 120.0 mm 17 1/4 x 11 1/2 x 4 3/4 inches	222.4 x 166 x 70 mm 8 7/8 x 6 5/8 x 2 7/8 inches (when AC adaptor is detached)
Mass	10.6 kg 23 lb 5.9 oz 12.7 kg 27 lb 16 oz (with an optional SU-561 monitor stand)	7.2 kg 15 lb 14 oz 9.3 kg 20 lb 8 oz (with an optional SU-561 monitor stand)	2.0 kg 4 lb 6 oz 2.6 kg 5 lb 12 oz (When AC adaptor is installed)
Supplied accessories	AC power cord (1), AC plug holder (1), Operating Instructions (1), CD-ROM (1), Using the CD-ROM manual (1)	AC power cord (1), AC plug holder (1), Mounting bracket (2) (including 4 screws), Operating Instructions (1), CD-ROM (1), Using the CD-ROM manual (1)	AC power cord (1), AC plug holder (1), AC power adaptor (1), Operating Instructions (1), CD-ROM (1), Using the CD-ROM manual (1)

Optional Accessories

BKM-250TG

INPUT/OUTPUT	
Serial digital interface	BNC (x2), Digital component signals sampling frequency: 3G-SDI: Y/Cb/Cr: 148.5 MHz/74.25 MHz/74.25 MHz, G/B/R: 148.5 MHz/148.5 MHz/148.5 MHz HD-SDI: Y/Cb/Cr: 74.25 MHz/37.125 MHz/37.125 MHz, SD-SDI: Y/Cb/Cr: 13.5 MHz/6.75 MHz/6.75 MHz
Monitor out	BNC (x2), Output signal amplitude: 800 mVp-p ±10% Output impedance: 75 ohms unbalanced
Transmission distance	3G-SDI: 70 m (approx. 230 ft) max. (When using 5C-FB coaxial cables (Fujikura) or equivalent.) HD-SDI: 100 m (approx. 328 ft) max. (When using 5C-FB coaxial cables (Fujikura) or equivalent.) SD-SDI: 200 m (approx. 656 ft) max. (When using 5C-2V coaxial cables (Fujikura) or equivalent.)
GENERAL	
Voltage	+3.3 V, +5 V (supplied from the main unit)
Power consumption	Approx. 4 W
Operating temperature	0°C to 35°C (32°F to 95°F) Recommended: 20°C to 30°C (68°F to 86°F)
Operating humidity	0% to 90% (no condensation)
Operating pressure	700 hPa to 1060 hPa
Storage and trans. temperature	-20°C to +60°C (-4°F to +140°F)
Storage and trans. humidity	0% to 90%
Storage and trans. pressure	700 hPa to 1060 hPa
Dimensions (W x H x D)	100 x 20 x 162 mm (4 x 13/16 x 6 1/2 inches)
Mass	270 g (9.5 oz)
Supplied accessories	Operating Instructions (1)

BKM-243HS

INPUT/OUTPUT	
Serial digital interface	BNC (x2), Digital component signals sampling frequency: SD-SDI: Y/R-Y/B-Y: 13.5 MHz, HD-SDI: Y/Cb/Cr: 74.25 MHz Quantization: 10 bits/sample
Monitor out	BNC (x1), Output signal amplitude: 800 mVp-p ±10% Output impedance: 75 ohms unbalanced
Transmission distance	SD-SDI: 200 m (approx. 656 ft) max. (when using 5C-2V coaxial cables (Fujikura) or equivalent) HD-SDI: 100 m (approx. 328 ft) max. (when using 5C-FB coaxial cables (Fujikura) or equivalent)
GENERAL	
Voltage	+3.3 V, +5 V (supplied from the main unit)
Power consumption	Approx. 2 W
Operating temperature	0°C to 35°C (32°F to 95°F) Recommended: 20°C to 30°C (68°F to 86°F)
Operating humidity	0% to 90% (no condensation)
Operating pressure	700 hPa to 1060 hPa
Storage and trans. temperature	-20°C to +40°C (-4°F to +140°F)
Storage and trans. humidity	0% to 90%
Storage and trans. pressure	700 hPa to 1060 hPa
Dimensions (W x H x D)	100 x 20 x 162 mm (4 x 13/16 x 6 1/2 inches)
Mass	Approx. 250 g (9 oz)
Supplied accessories	Operating Instructions (1)

BKM-244CC

INPUT/OUTPUT	
Serial digital interface	BNC (x2), Digital component signals sampling frequency: SD-SDI: Y/R-Y/B-Y: 13.5 MHz, HD-SDI: Y/Cb/Cr: 74.25 MHz Quantization: 10 bits/sample
Monitor out	BNC (x1), Output signal amplitude: 800 mVp-p ±10% Output impedance: 75 ohms unbalanced
Transmission distance	SD-SDI: 200 m (approx. 656 ft) max. (when using 5C-2V coaxial cables (Fujikura) or equivalent) HD-SDI: 100 m (approx. 328 ft) max. (when using 5C-FB coaxial cables (Fujikura) or equivalent)
GENERAL	
Voltage	+3.3 V, +5 V (supplied from the main unit)
Power consumption	Approx. 4 W
Operating temperature	0°C to 35°C (32°F to 95°F) Recommended: 20°C to 30°C (68°F to 86°F)
Operating humidity	0% to 90% (no condensation)
Operating pressure	700 hPa to 1060 hPa
Storage and trans. temperature	-10°C to +40°C (14°F to 104°F)
Storage and trans. humidity	0% to 90%
Storage and trans. pressure	700 hPa to 1060 hPa
Dimensions (W x H x D)	100 x 20 x 162 mm (4 x 13/16 x 6 1/2 inches)
Mass	250 g (9 oz)
Supplied accessories	Operating Instructions (1)

BKM-229X

INPUT/OUTPUT	
RGB / Component	BNC (x3) RGB: 0.7 Vp-p ±3 dB (Sync on Green, 0.3 Vp-p sync negative) Component: 0.7 Vp-p ±3 dB
External sync input	BNC (x1), 0.3 Vp-p to 4 Vp-p ± bipolarity ternary or negative polarity binary Mini DIN 4-pin (x1), Loop-through, with 75 ohms automatic termination
GENERAL	
Voltage	+3.3 V, +5 V (supplied from the main unit)
Power consumption	Approx. 4 W
Operating temperature	0°C to 35°C (32°F to 95°F) Recommended: 20°C to 30°C (68°F to 86°F)
Operating humidity	0% to 90% (no condensation)
Operating pressure	700 hPa to 1060 hPa
Storage and trans. temperature	-20°C to +60°C (-4°F to +140°F)
Storage and trans. humidity	0% to 90%
Storage and trans. pressure	700 hPa to 1060 hPa
Dimensions (W x H x D)	100 x 20 x 162 mm (4 x 13/16 x 6 1/2 inches)
Mass	250 g (9 oz)
Supplied accessories	Operating Instructions (1)

BKM-227W

INPUT/OUTPUT	
Composite input	BNC (x1), 1 Vp-p \pm 3 dB sync negative
Y/C input	Mini DIN 4-pin (x1) Y: 1 Vp-p \pm 3 dB sync negative C: 0.286 Vp-p \pm 3 dB (NTSC burst signal level), 0.3 Vp-p \pm 3 dB (PAL, PAL-M burst signal level)
Monitor out	BNC (x1), Loop-through, with 75 ohms automatic termination Mini DIN 4-pin (x1), Loop-through, with 75 ohms automatic termination
GENERAL	
Voltage	+3.3 V, +5 V (supplied from the main unit)
Power consumption	Approx. 1.8 W
Operating temperature	0°C to 35°C (32°F to 95°F) Recommended: 20°C to 30°C (68°F to 86°F)
Operating humidity	0% to 90% (no condensation)
Operating pressure	700 hPa to 1060 hPa
Storage and trans. temperature	-20°C to +60°C (-4°F to +140°F)
Storage and trans. humidity	0% to 90%
Storage and trans. pressure	700 hPa to 1060 hPa
Dimensions (W x H x D)	100 x 20 x 162 mm (4 x 13/16 x 6 1/2 inches)
Mass	240 g (8 oz)
Supplied accessories	Operating Instructions (1)

BKM-220D

INPUT/OUTPUT	
Serial digital interface	BNC (x2), Digital component signals sampling frequency: Y/R-Y/B-Y: 13.5 MHz Quantization: 10 bits/sample
Monitor out	BNC (x1), Output signal amplitude: 800 mVp-p \pm 10% Output impedance: 75 ohms unbalanced
Transmission distance	200 m (approx. 656 ft) max. (when using 5C-2V coaxial cables (Fujikura) or equivalent)
GENERAL	
Voltage	+5 V (supplied from the main unit)
Power consumption	Approx. 1.5 W
Operating temperature	0°C to 35°C (32°F to 95°F) Recommended: 20°C to 30°C (68°F to 86°F)
Operating humidity	0% to 90% (no condensation)
Operating pressure	700 hPa to 1060 hPa
Storage and trans. temperature	-20°C to +60°C (-4°F to +140°F)
Storage and trans. humidity	0% to 90%
Storage and trans. pressure	700 hPa to 1060 hPa
Dimensions (W x H x D)	100 x 20 x 162 mm (4 x 13/16 x 6 1/2 inches)
Mass	250 g (9 oz)
Supplied accessories	Operating Instructions (1)

BKM-16R

INPUT/OUTPUT	
LAN	10BASE-T/100BASE-TX connector: RJ-45 (x1)
DC 5 V / 12 V IN	Circle 4-pin (male) (x1)
GENERAL	
Power requirements	DC IN: 5 V, 1.1 A (supplied by the connected monitor) DC IN: 12 V, 0.5 A (supplied by the connected AC adaptor) AC adaptor: AC IN: 100 V to 240 V, 50/60 Hz, DC OUT: 12 V, 3 A
Current consumption	5 V DC, 1.1 A / 12 V DC, 0.5 A
Power consumption	Approx. 6 W
Operating temperature	0°C to 35°C (32°F to 95°F), Recommended: 20°C to 30°C (68°F to 86°F)
Operating humidity	0% to 90% (no condensation)
Operating pressure	700 hPa to 1060 hPa
Storage and trans. temperature	-10°C to +40°C (14°F to 104°F)
Storage and trans. humidity	0% to 90%
Storage and trans. pressure	700 hPa to 1060 hPa
Dimensions (W x H x D)	424 x 58.8 x 174.9 mm (16 3/4 x 2 3/8 x 7 inches)
Mass	2.1 kg (4 lb 10 oz)
Supplied accessories	AC adaptor (1), AC power cord (parts number: 1-757-562-1x1 for USA and Canada, 1-575-131-8x for Europe) (1), Rack mount brackets (2), Rack mount attachment screws (4), Function labels (2), Operation manual (1)

Optional Accessories

For BVM-E250, BVM-E170, BVM-F250, and BVM-F170



BKM-16R
Monitor Control Unit



BKM-250TG
3G/HD/SD-SDI Input Adaptor



BKM-244CC
HD/SD-SDI Closed Caption Adaptor



BKM-243HS
HD/SD-SDI Input Adaptor



BKM-220D
SD-SDI 4:2:2 Input Adaptor



BKM-229X
Analogue Component Adaptor



BKM-227W
NTSC/PAL Input Adaptor



BKM-37H
Controller Attachment Stand
(for BVM-E250 / BVM-F250)



BKM-38H
Controller Attachment Stand
(for BVM-E250 / BVM-F250)



BKM-39H
Controller Attachment Stand
(for BVM-E170 / BVM-F170)



SMF-700
Monitor Interface Cable

For PVM-2541 and PVM-1741



SU-561
Monitor Stand

For PVM-740



MB-531
Mounting Bracket



MB-532
Mounting Panel



VF-510
ENG Kit (Viewing Hood, Carrying
Handle and Connector Protector)

Dimensions

BVM-E Series

Unit: mm (inches)

■ BVM-E250 / BVM-F250

Front

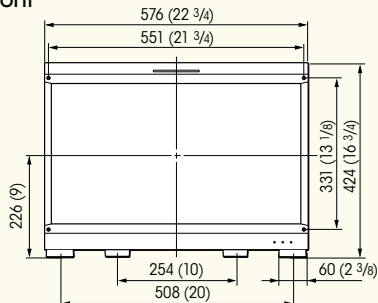

Rear

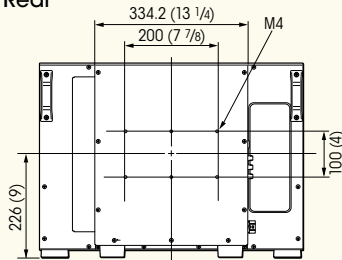

Side

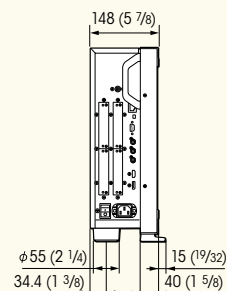

■ BVM-E250 / BVM-F250 with the optional BKM-16R and BKM-37H with a tilt

Front

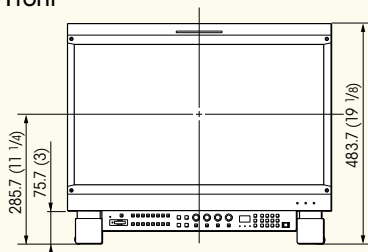

Bottom

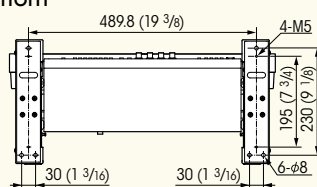

Side

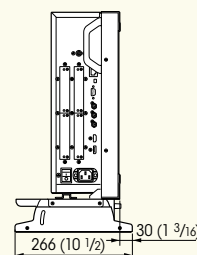

■ BVM-E250 / BVM-F250 with the optional BKM-16R and BKM-38H

Front

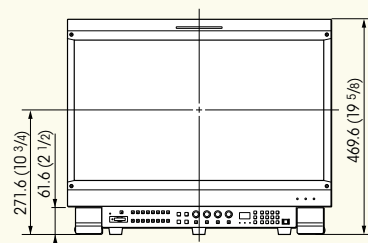

Bottom

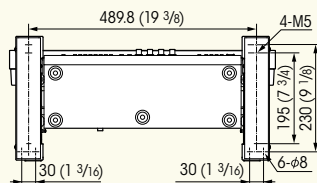

Side

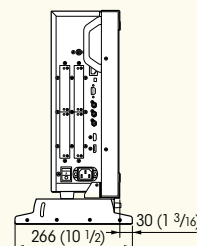

■ BVM-E170 / BVM-F170

Front

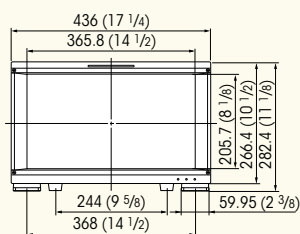

Rear

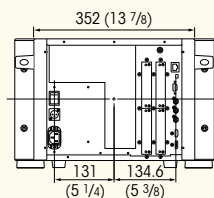

Side

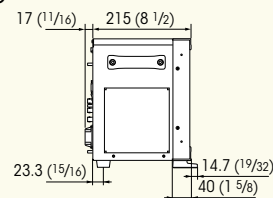

■ BVM-E170 / BVM-F170 with the optional BKM-16R and BKM-39H

Front

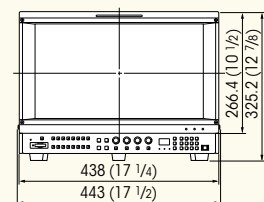

Bottom

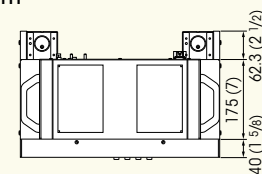

Side

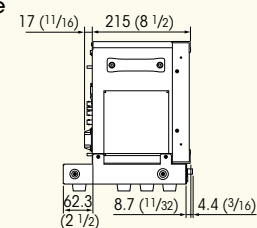

PVM Series

Unit: mm (inches)

■ PVM-2541

Front

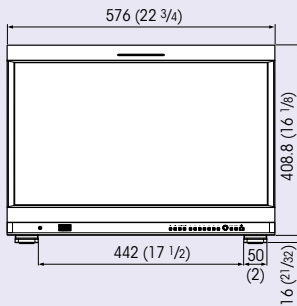

Rear

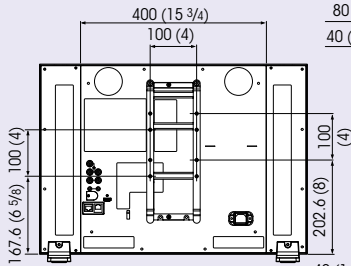

Side

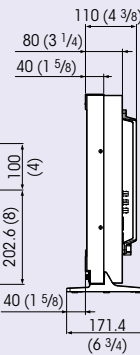

■ PVM-2541 with the optional SU-561 stand

Front

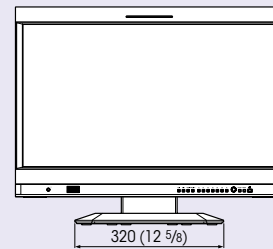

Side

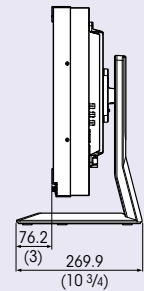

■ PVM-1741

Front

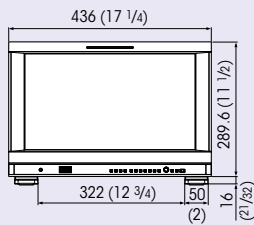

Rear

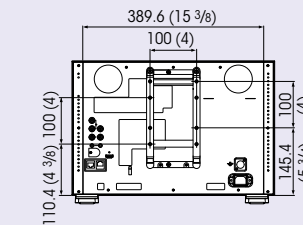

Side

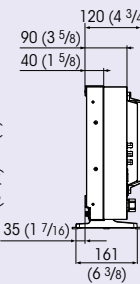

■ PVM-1741 with the optional SU-561 stand

Front

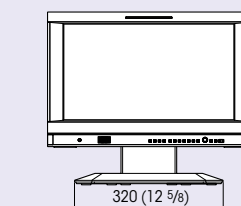

Side

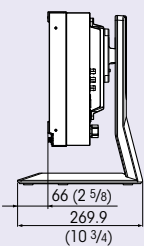

■ PVM-740

Front

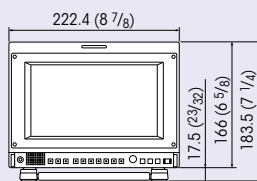

Side

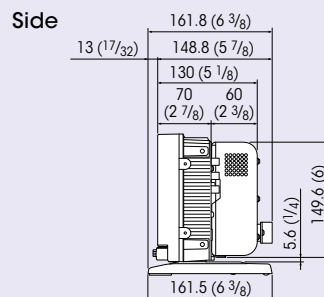

■ BKM-16R

Unit: mm (inches)

Front

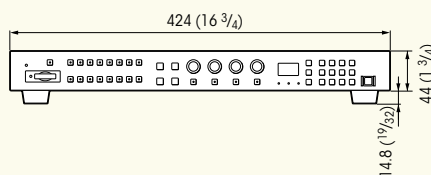

Top

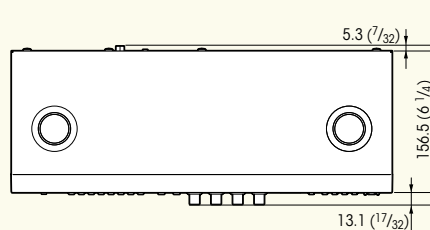

Side

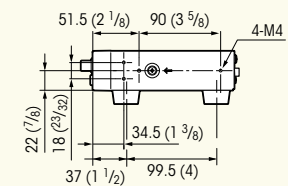

SONY

make.believe

Distributed by

©2012 Sony Corporation. All rights reserved.

Reproduction in whole or in part without written permission is prohibited.

Features and specifications are subject to change without notice.

Screen images are simulated.

The values for mass and dimension are approximate.

"SONY", "make.believe", "TRIMASTER", "TRIMASTER EL", "ChromaTRU",

"Memory Stick", "Memory Stick PRO", "Memory Stick Duo", "Memory Stick PRO Duo", and "Memory Stick Micro" are trademarks of Sony Corporation.

HDMI is a trademark of HDMI Licensing, LLC.

All other trademarks are the properties of their respective owners.

The BVM-E250, BVM-E170, BVM-F250, and BVM-F170 are produced at Sony EMCS Corporation Tokai Tec, which has received ISO14001 Environmental Management System certification.

The PVM-2541, PVM-1741, and PVM-740 are produced under control of the Sony EMCS Corporation Tokai Tec.

MK10815V4EYIT12MAR

