



SCORPIO

PREMIUM PORTABLE MIXER-RECORDER

USER GUIDE

SOUND  **DEVICES**

Legal Notices

Product specifications and features are subject to change without prior notification.

Copyright© 2021 Sound Devices, LLC. All rights reserved. This product is subject to the terms and conditions of a software license agreement provided with the product, and may be used in accordance with the license agreement. This document is protected under copyright law. An authorized licensee of this product may reproduce this publication for the licensee's own personal use. This document may not be reproduced or distributed, in whole or in part, for commercial purposes, such as selling copies or providing educational services or support. This document is supplied as a technical guide. Special care has been taken in preparing the information for publication; however, since product specifications are subject to change, this document might contain omissions and technical or typographical inaccuracies. Sound Devices, LLC does not accept responsibility for any losses due to the user of this guide.

Trademarks

The "wave" logo, SuperSlot, and Wave Agent are trademarks of Sound Devices, LLC. Dante is a registered trademark of Audinate. Windows and Microsoft Excel are registered trademarks of Microsoft Corporation in the U.S. and other countries. Bluetooth LE is a registered trademark of Bluetooth SIG, Inc. Android is a registered trademark of Google. iPad is a registered trademark of Apple Inc. All other trademarks herein are the property of their respective owners.



WEEE Statement

If you wish to discard a Sound Devices product in Europe, contact Sound Devices (Germany) for further information.



Warning! This device can drive headphones to potentially dangerous levels. Do not listen at high volume levels for long periods.

Read and fully understand this manual before operation.

Included Accessories

DESCRIPTION
Cordset 6' AC cable
XL-WPTA4 power supply TA4 Connector
Scorpio LCD cover
Antenna, SMA connector
Promo Sticker (white)
Promo sticker (black)
Dot: Red, Yellow, Blue, Green, Purple, White (8 each)

Manual Conventions

SYMBOL	DESCRIPTION
>	This symbol is used to show the order in which you select menu commands and sub-options, such as: Main Menu > Outputs indicates you press the Menu button for the Main Menu, then scroll to and select Outputs by pushing the Knob.
[]	This symbol is used to convey selectable menu items.
*	This symbol is used to convey factory default settings.
+	A plus sign is used to show button or keystroke combinations. For instance, Ctrl+V means to hold the Control key down and press the V key simultaneously. This also applies to other controls, such as switches and knobs. For instance, MIC+HP turn means to slide and hold the MIC/TONE switch left while turning the Headphone (HP) knob. METERS+SELECT means to hold the METERS button down as you press the SELECT knob.
Note	A <i>note</i> provides recommendations and important related information. The text for notes appears italicized.
*	A cautionary warning about a specific action that could cause harm to you, the device, or cause you to lose data. Follow the guidelines in this document or on the unit itself when handling electrical equipment. The text for cautionary notes also appears italicized and bold in a different color.



Post Office Box 576
E7556 State Rd. 23 and 33
Reedsburg, Wisconsin 53959 USA
www.sounddevices.com

+1 608.524.0625 main
800.505.0625 toll free
support@sounddevices.com

Scorpio User Guide 12/21

This document is distributed by Sound Devices, LLC in Online electronic (PDF) format only. Published in the USA.

This table provides the revision history and cross-reference to “what’s new” in this guide.

DATE	DESCRIPTION
05/19	v1.0 Initial release
07/19	v1.20 SL-6 Operation, Sticky Notes, Take List, File Copy
08/19	v2.00 Dugan Automix, Additional USB MIDI Controller support, Nested Folder Support, SL-6 Support for Sennheiser 6042
10/19	v3.00 MixAssit, CL-12 Support, Timecode stamped AAC file recording, Smart Battery telemetry, Horizontal Meter Options
12/19	v3.10 Support for the XL-AES accessory, new graphical EQ, USB audio input/output, new headphone encoder menu
02/20	v3.20 Bluetooth LE support for SD-Remote, new Bluetooth menu option
02/20	v3.21 SD-Remote support for iPad
04/20	v4.00 Support for CL-16, output naming, bus soloing, custom SD card names
05/20	v5.00 Support for NoiseAssist and the Sonosax SX-LC8+ Controller.
07/20	v6.00 Support for the SL-2, new Audio Ltd A10 SuperSlot screens
08/20	v6.10 Support for P.I. Engineering’s X-keys® Programmable Keypads, Sticks & Keyboards
09/20	v7.00 Support for the Wisycom MCR54, Compressors, Q-marks, Soft pickup for faders, enhanced control via SD-Remote
10/20	v7.10 New record folder prompts when recording after midnight, link quality indicator for Wisycom MCR54
12/20	v7.20 SD-Remote for iPhone support. Support for optional four- and eight-instances of NoiseAssist Plugin. NoiseAssist instances can now be applied to any bus.
01/21	v7.30 Sony DWR-S03D SuperSlot support. SD-Remote for Android phones support
01/21	v7.40 CEDAR sdx Plugin. Record Folder and Take Renaming.
03/21	v8.00 Frame.io, CL-16 Channel Colors, Flexible L and R Output Routing, Bus Naming, and Channel Copy
04/21	v8.01 Frame.io options for disconnecting/pausing now or after upload completes
07/21	v8.10 Support for A20-Mini
09/21	v8.50 SuperSlot support of Shure ADX5D
10/21	v8.60 Updated Frame.io menu
11/21	v8.70 Meter Ballistics menu and LCD Brightness shortcut
12/21	v8.80 SD-Remote Power Source icon, Channel Copy for channels 17-32, SL-2 RF Overload LED change, and other minor updates

Welcome to Scorpio

THE NEW ERA OF PRODUCTION SOUND.

Dear Sound Professionals,

Thank you very much for your interest and purchase of the Scorpio. We at Sound Devices are extremely proud of this product. We consider the Scorpio our best yet, from every aspect.

We also want to thank you for your direct contribution to this product's success. Countless conversations were shared with industry professionals regarding workflows, frustrations, wants, and needs. The knowledge obtained from these conversations drove the design and engineering of the Scorpio.

Please stay in touch. We will always be here to help, listen to feature requests, and hear about your adventures with the Scorpio.

We are honored to be part of your kit.

Sincerely,
Sound Devices

Table of Contents

PANEL VIEWS.....	1	PLUGINS.....	45
FRONT PANEL.....	1	INSTALLING PLUGINS.....	45
LEFT SIDE PANEL.....	3	NOISE SUPPRESSION PLUGINS.....	46
RIGHT SIDE PANEL.....	4	CEDAR SDNX.....	46
REAR PANEL.....	5	SOUND DEVICES NOISEASSIST.....	46
TOP PANEL.....	5	CONTROLLERS.....	48
HOME SCREEN.....	6	CL-16.....	49
CHANNEL SCREEN.....	7	CL-12.....	50
CHANNEL INPUT SOURCE.....	8	SUPPORTED THIRD-PARTY CONTROLLERS..	51
CHANNEL BUS SENDS.....	8	TOGGLE SWITCH ACTION.....	54
VIRTUAL KEYBOARD.....	9	FRONT PANEL SHORTCUTS.....	55
PHRASE MANAGER.....	10	USB KEYBOARD.....	56
CHANNEL EQ.....	11	SD-REMOTE.....	57
CHANNEL COMPRESSION.....	11	TABLET.....	60
CHANNEL COPY.....	11	PHONE.....	60
MENUS.....	12	QUICK SETUP.....	66
POWER.....	13	DANTE.....	67
CHANNEL SETUP.....	14	USB-A.....	67
CHANNELS 13-32.....	14	USB-C.....	67
BUSES.....	15	SPECIFICATIONS.....	68
OUTPUTS.....	16	FCC & ISED COMPLIANCE STATEMENTS.....	70
LIMITERS.....	18	DECLARATION OF CONFORMITY.....	71
AUTOMIXER.....	19	WARRANTY.....	72
DUGAN AUTOMIXER.....	19	GLOSSARY.....	73
MIXASSIST.....	20		
METERS.....	21		
TIMECODE.....	22		
RECORD/PLAY.....	23		
Q-MARKS.....	24		
FILES.....	25		
FRAME.IO.....	28		
SLATE/COMS/RETURNS.....	31		
SUPERSLOT.....	32		
SL-2.....	32		
SL-6.....	35		
RECEIVER SETUP SCREENS.....	39		
AUDIO LTD A10-RX.....	40		
GAINFORWARD (A20-MINI).....	40		
THIRD-PARTY SUPERSLOT RECEIVERS.....	40		
SYSTEM.....	44		

Panel Views

FRONT PANEL

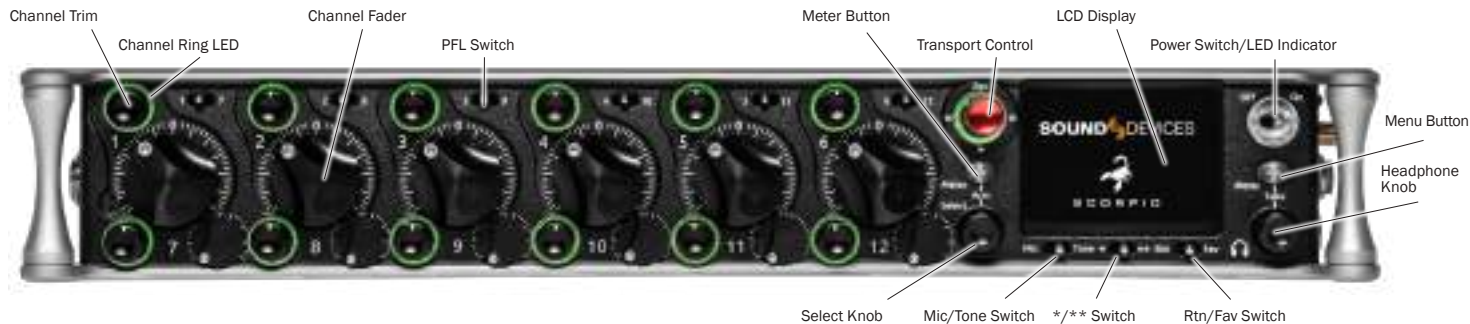

CHANNEL TRIM Turns the channel on/off and sets the input sensitivity for the channel. To conserve power, turn off unused channels by rotating channel trim fully counterclockwise. Channel 13-32 trims are accessible via the Channels 13-32 menu or using */** + PFL switch shortcuts. Use Toggle Switch Actions to set the Select and /or HP knobs as trims for Ch 13,14.

CHANNEL LED RING Provides visual indication of channel signal condition, solo and mute, and whether a channel is on or off.

CHANNEL FADER Controls the audio level of the channel as it contributes to the L/R mix and any destinations selected in routing as "Post". Channel 13-32 faders are accessible via the Channels 13-32 menu or using */** + PFL switch shortcuts. Use Toggle Switch Actions to set the Select and /or HP knobs as faders for Ch 13,14.

PFL SWITCH Pre/Post Fade Listen selects the channel in the headphones for Pre/Post Fade Listen while simultaneously entering the channel screen. Also used for accessing virtual keyboard for channel naming and various shortcuts. Channel 13-32 PFLs are accessible via the Channels 13-32 menu or using */** + PFL switch shortcuts. Use Toggle Switch Actions to set the Select and /or HP knobs as PFLs for Ch 13,14.

TRANSPORT CONTROLS A joystick (with its illuminated LED ring) on the front panel is used to perform various transport control functions. (See table). The ring LED will flash orange indicating post roll while writing to media.

Function	Action
Record	Push up the Transport control to begin recording a new file. The LED ring illuminates red while recording is underway.
Stop	Press in the Transport control to stop recording or playback. While in standby, press and hold to display next take name.
Play	Push down on the Transport control to begin playback of the last file recorded or file currently loaded. While in playback, push down again to pause playback. The LED ring as well as the active file in the display will flash to indicate that Pause is active. Push down again to continue playback.
Rewind / Load Previous Take	While in standby, push left to load the previous take. While in playback, push and hold left to rewind. When the Scorpio is playing back or paused, moving the joystick to the left (<<) rewinds at 2x speed, then after holding for 5 seconds, it increases to 16x speed. Push Left while holding Select to delete the current Q-mark
Fast Forward / Load Next Take	While in standby, push right to load the next take. While in playback, push and hold right to rewind. When the Scorpio is playing back or paused, moving the joystick to the right (>>) fast forwards at 2x speed, then after holding for 5 seconds, it increases to 16x speed.. Push right while holding Select to add a Q-mark.
Scrub	While playing or paused, press the headphone knob >0.5 s to enter Scrub mode. Then rotate clockwise for fast forward or counter-clockwise for rewind speeds of 0x, 1/8x, 1/4x, 1/2x, 1x, 2x, 4x, 8x, and 16x. The audio may be heard in scrub mode up to 2x speed.

METER BUTTON Push to view and select various metering presets. Used with Select Knob. Press again to return to Home Screen. Push with channel Select switched 1-12 for shortcut to Meters Preset 1-12. Push and rotate HP knob to zoom meter scale. Push and Push HP knob to access Receiver Overview screen if a SuperSlot accessory is connected.

SELECT KNOB

1. Push to view Outputs list, rotate and push to Select Output Screen. Push Meter Button to return to Home Screen.
2. Rotate to select track in display, push both Meter and Select at the same time to arm/disarm track. While holding the Meter Button, multiple consecutive tracks may be armed by holding in the Select Knob and rotating.
3. Use with Meter Button to scroll through meter views then push to Select.
4. Push with Channel Select switches 1-12 for shortcut to Bus 1-10, L,R routing.
5. Menu navigation and push to Select.
6. Hold then press >>, <<, to add, delete Q-marks during recording and playback.

MIC/TONE SWITCH Toggle slate mic and tone generator. Soft button for menus.

Hold Select then activate Tone switch for L-Ident tone.

Mappable functions via the Toggle Switch Action menu.

***/** SWITCH** Shortcut with PFL switch to access channels 13-24 and 25-32. Soft button for menus.

Mappable functions via the Toggle Switch Action menu.

RTN/FAV SWITCH Toggle Rtn and Fav actions. Soft button for menus.

Mappable functions via the Toggle Switch Action menu.

POWER SWITCH/LED INDICATOR Turns the power on and off.

Switch LED ring indicates the following:

1. Power condition: green = good, yellow = warning, red = shutdown imminent.
2. Flashing blue = power is off and holding timecode.
3. Continuous blue = booting up.
4. Flashing yellow = unit is off and charging L-mount batteries.
5. Continuous yellow = unit is off and both L-mount batteries are fully charged.

MENU BUTTON Push to enter the Main menu. Also used to exit menus. The Menu button will flash red to indicate clipping on the headphones. Press with Channel Select switches 1-12 for shortcuts to Menu Favorites 1-12.

HEADPHONE KNOB

1. Rotate to control headphone volume.
 2. Press to open headphone preset menu and select.
 3. Menu navigation and push to select.
 4. Press Menu and HP knob to enter Take List.
 5. Press > 0.5 s during playback to enter audio scrub mode.
- Press with Channel Select switches 1-12 for shortcuts to HP Presets 1-12.
- Any output getting headphone left or right signals will see changes to hp levels.

LEFT SIDE PANEL

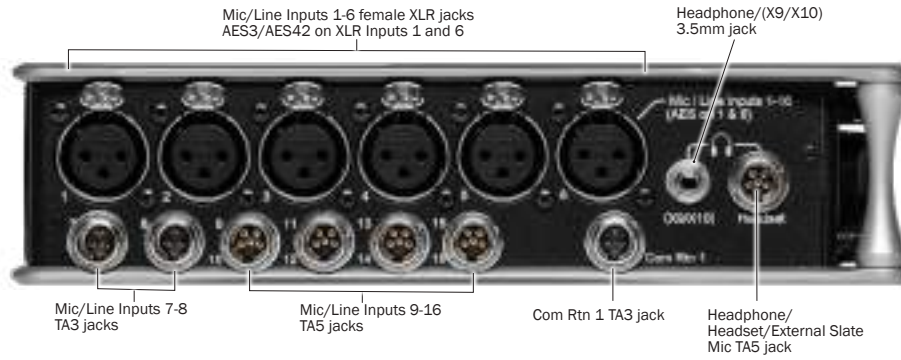

INPUTS 1-6 FEMALE XLR JACKS Active-balanced analog microphone or line-level inputs. Inputs 1 and 6 can also accept AES3 or AES42 signal. [pin-1 = ground, pin-2 = hot (+), and pin-3 = cold (-)] *110 ohm cables should be used for AES3 or AES42 inputs.*

MIC/LINE INPUTS 7-8 TA3 JACKS Active-balanced analog microphone or line-level inputs. [pin-1 = ground, pin-2 = hot (+), pin 3 = cold (-)]

MIC/LINE INPUTS 9-16 TA5 JACKS Active-balanced analog microphone or line-level inputs. [pin-1 = ground, pin-2 = Ch.1 +, pin-3 = Ch.1 -, pin-4 = Ch.2 +, pin-5 = Ch. 2 -]

COM RTN 1 TA3 JACK Balanced connection for Com Return 1 audio input. [pin-1 = Ground, pin-2 = hot (+), pin-3 = cold (-)]

HEADPHONE/(X9/X10) 3.5 MM JACK Unbalanced output and TRS headphone output. *Warning! This output can drive headphones to potentially dangerous levels.* Routing determined in the Outputs menu. [Sleeve = ground, tip = left (X9), ring = right (X10)]

HEADPHONE/HEADSET TA5 JACK Headphone and slate microphone connections [pin-1 = HP right, pin-2 = HP left, pin-3 = ground, pin-4 = Mic -, pin-5 = Mic+]

Route HP-L and HP-R to X9/X10 to control headphone level with the headphone knob and to send headphone signal to the TA5 output.

RIGHT SIDE PANEL

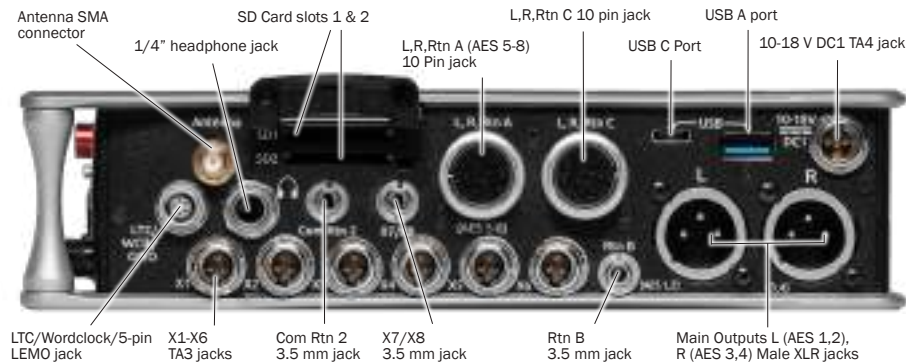

ANTENNA RP-SMA-MALE CONNECTOR Connects to included external antenna for Bluetooth LE.

SD 1 AND 2 CARD SLOTS Insert SD card media for recording. Insert label side down.

L,R,RTN A (AES 5-8) AND C 10-PIN JACKS Each connection includes a pair of outputs and a stereo unbalanced return input. Analog Output levels are selected between Line, -10, and Mic levels in Main menu > OUTPUTS section. 10-pin A outputs can be set to send AES3 digital signals (AES 5-8). Output may be sourced from L,R or any of the 10 mix buses in Main menu > OUTPUTS.

USB C PORT

1. File transfer.
2. 2-in/2-out USB audio streaming.

USB A PORT

1. USB keyboard.
2. USB to SD-Remote Android app.
3. USB to the CL-16, CL-12, and approved 3rd party fader controllers.
4. Supports USB hubs.
5. Jam A20-Mini Timecode.

10-18V DC1 TA4 JACK Accepts DC voltages from 10–18 V for powering. [pin-1- GND, pin-2- Smart Battery DATA, pin-3- Smart Battery CLOCK, pin-4- +10-18 VDC]

LTC/WORDCLOCK/5-PIN LEMO JACK Timecode I/O, Wordclock. [pin-1- GND, pin-2- LTC or WORDCLOCK IN, pin-5- LTC or WORDCLOCK OUT (Pins 2 and 5 are software selectable)].

1/4" HEADPHONE JACK 1/4-inch TRS headphone output. This output is always fed by the headphone source levels. Warning! This output can drive headphones to potentially dangerous levels. [Sleeve = ground, tip = left, ring = right]

COM RTN 2 3.5 MM JACK Balanced, 1-channel 3.5 mm female connector for Return 2 audio input. [Sleeve = ground, tip = hot, ring = cold]

X7/X8 3.5 MM JACK Unbalanced stereo 3.5 mm female connector. Routing determined in the Outputs menu. [Sleeve = ground, tip = X7, ring = X8]

X1-X6 TA3 JACKS Line, -10, or Mic level selected in Main menu OUTPUTS section. Routing determined in the Outputs menu. [pin-1 = Ground, pin-2 = hot (+), pin-3 = cold (-). Float pin-3 to unbalance]

RTN B 3.5 MM JACK Unbalanced stereo 3.5 mm female connector for Return B audio input. [Sleeve = ground, tip = left, ring = right]

MAIN OUTPUTS L (AES 1,2), R (AES 3,4) XLR JACKS Analog outputs on standard 3-pin XLR-3M connectors. Analog Output levels are selected between Line, -10, and Mic levels in Main menu > OUTPUTS. Can be set to send AES3 digital signals (1,2 and 3,4 on L and R respectively) in Main menu > OUTPUTS. Routing determined in the Outputs menu. [pin-1 = Ground; pin-2 = hot (+); pin-3 = cold (-). Unbalance by floating pin-3]

REAR PANEL

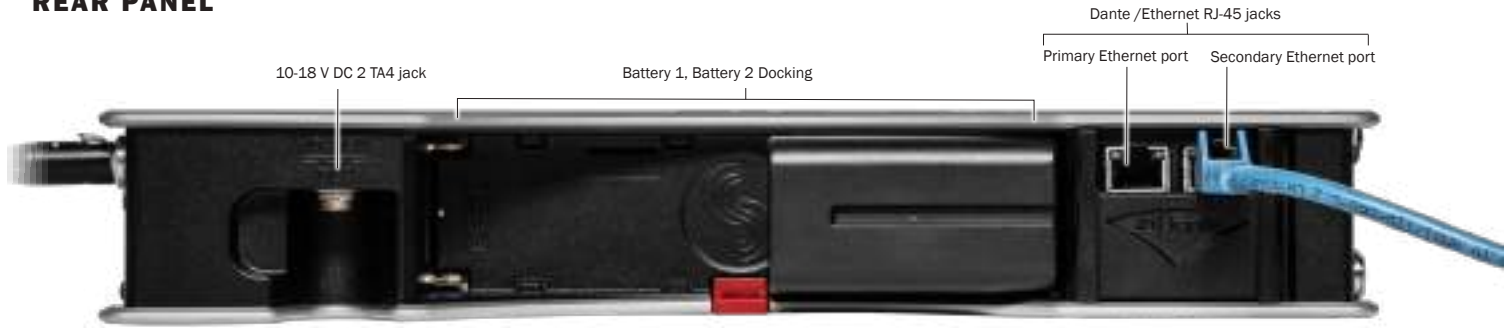

10-18V DC2 TA4 JACK Accepts DC voltages from 10–18 V for powering. [pin-1- GND, pin-2- Smart Battery DATA, pin-3- Smart Battery CLOCK, pin-4- +10-18 VDC]

BATTERY 1, BATTERY 2 DOCKING Sony L-Mount type batteries may be used. When connected to an external DC source via DC1 or DC2 the L-Mount batteries can be charged if enabled in the Power menu.

DANTE/ETHERNET RJ45 JACKS Two-1 GbE ports serving as connections to Dante audio networks or to Frame.io servers. The Dante interface provides 32 inputs and 32 outputs simultaneously with sampling rates up to 96 kHz. Routing is defined through the Channel Source and Output menus. Dante Controller app on Mac/PC (from Audinate) is needed to route and use Dante. Allows connection to Frame.io and setup. See Frame.io for more details.
Do not connect both Primary and Secondary Ethernet ports to the same network.

TOP PANEL



EXPANSION PORT Used for connecting XL-AES 8 Channel AES3 Input Expander and SL-2 Dual SuperSlot Wireless Module.

SL-6 PORT Multipin Molex Ribbon connector used for connecting SL-6. Remove all power on Scorpio and the SL-6 before connecting. The SL-Riser is required to connect the SL-6 to Scorpio.

HOME SCREEN

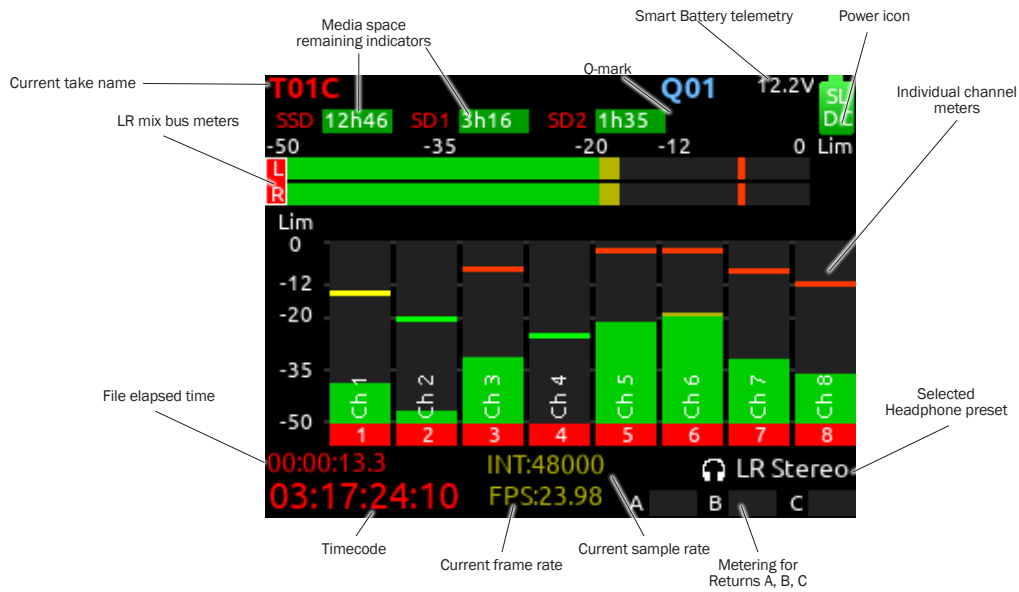

CURRENT TAKE NAME Shows the filename of the currently-selected take.

SSD, SD1, SD2 Indicates the amount of recording time available based on current track count, sample rate, and media routing. The internal SSD drive has a capacity of 256 GB.

POWER ICON Indicates approximate voltage condition and current power source being used. When Smart Batteries are in use the remaining percentage and time is displayed.

LR MIX BUS METERS WITH ARM/DISARM INDICATION Indicates the peak and VU audio levels of the L/R mix. The L and R indicators turn red to indicate that the tracks are armed for record.

INDIVIDUAL CHANNEL METERS WITH ARM INDICATION Indicates the peak and VU audio levels of the individual channel. May be Pre- or Post- fade depending on Channel to ISO routing.

FILE ELAPSED/ REMAINING TIME Indicates in Hours:Minutes:Seconds:1/10ths the elapsed time of the current file. During playback, displays the elapsed and remaining time in hours, minutes and seconds.

TIMECODE Indicates current SMPTE timecode value.

Q-MARK Indicates Q-mark number.

SAMPLE RATE / FRAME RATE/ TEMPORARY LEVEL DISPLAY

1. Indicates current sample rate.
2. Indicates current frame rate.
3. Temporarily indicates fader level of last moved fader (red text box).
4. Temporarily indicates trim level of last moved trim (green text box).
5. Temporarily indicates bus level of last adjusted bus fader (light blue text box).
6. Temporarily indicates output level of last adjusted out gain (white text box).
7. Temporarily indicates EQ freq and gain of last adjusted EQ (blue text box when EQ is On, orange text box when EQ is off or band is bypassed).

SMART BATTERY TELEMETRY Indicates time remaining and percent remaining of Smart Battery life. Other power sources will show voltage.

SELECTED HEADPHONE PRESET Indicates the currently-selected headphone preset.

METERING FOR RETURNS A, B AND C Indicates audio level for the returns.

CHANNEL SCREEN

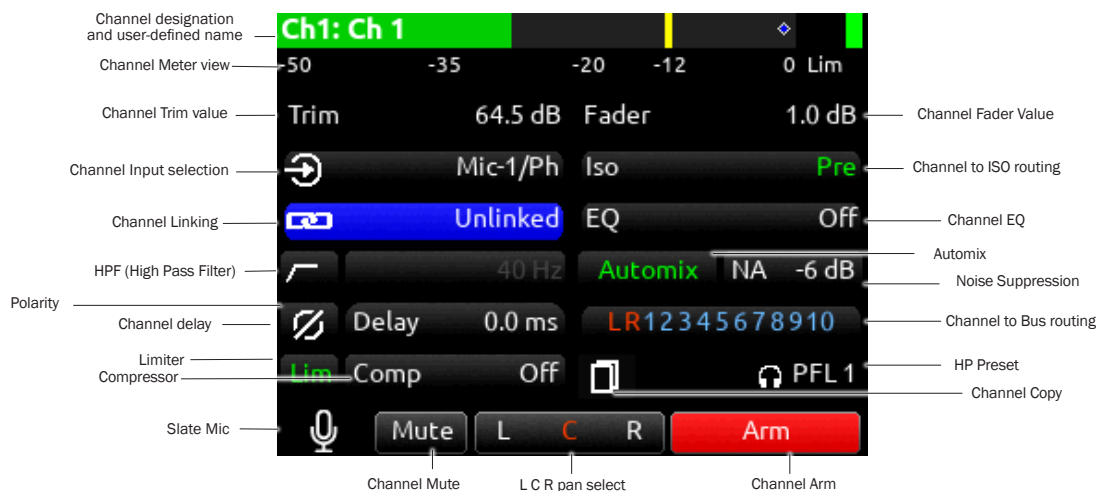

CHANNEL DESIGNATION AND USER-DEFINED NAME Indicates the mixer channel designation and the user-defined name. Both are overlaid onto the channel audio meter. When in a Channel Screen, hold the PFL Switch for about 0.5 s to enter the virtual keyboard and enter a user-defined name for the channel.

CHANNEL METER VIEW Indicates the audio level of the channel. Metering follows ISO Routing selection, Pre- or Post-fade.

CHANNEL TRIM VALUE Indicates the gain of the channel trim control. The gain range depends on the type of input selected.

Mic: -inf, +12 to +76 dB
 Line: -inf, -14 to +50 dB
 Dante: -inf, -20 to +50 dB
 SL-2 (Rx): -inf, -20 to +50 dB
 SL-2 (AES): -inf, -20 to +50 dB
 SL-6: -inf, -20 to +50 dB
 SL-2/SL-6 (A20-Mini GainForward): -inf, 0 to +60 dB
 AES3: -inf, -20 to +50 dB
 AES42: -inf, 0 to +70 dB
 XL-AES: -inf, -20 to +50 dB
 Returns: -inf, -20 to +30 dB

CHANNEL FADER VALUE Indicates the level of the channel fader control, continuously-variable from -inf to +16dB.

CHANNEL INPUT SELECTION Indicates which physical audio input is feeding the channel.

ISO (CHANNEL->ISO) ROUTING Indicates where the isolated track's audio is tapped from in the audio chain. Pre-fade or Post-fade.

CHANNEL LINKING Indicates the current linking status. The linking options are Unlinked, adjacent channels (eg. 1,2) and adjacent channels Mid Side (eg. 1-2MS). Linked parameters are: trims, faders, HPF, EQ, delay, limiter, mute, ISO, Bus Send 1 and Bus Send 2. Stereo panning is 1 to L and 2 to R. Adjust the MS balance (width) in the 'M' channel's MS balance field by holding */** and rotating Select.

CHANNEL EQ Indicates the EQ position in the audio chain. Pre(fade) or Post(fade). Select to enter Channel EQ screen.

AUTOMIX Indicates whether the channel is selected for automixing. Purple text = On and white text = Off.

CHANNEL COPY Select to copy parameters from the current channel to any combination of other channels.

NOISE SUPPRESSION (NA OR NX) Indicates whether the channel is selected for Sound Devices NoiseAssist (NA) or CEDAR sdnx (NX) and how much is applied. Field is grayed out when the Noise Suppression is disabled. White '-' (dashes) when Noise Suppression is enabled but channel not selected; white 'dB' value when channel is selected. NoiseAssist and CEDAR sdnx are optional paid Plugins.

HPF (HIGH PASS FILTER) Indicates on/off status where green icon and white value = "On" and gray icon and value = "Off". The HPF frequency is variable in 10 Hz steps from 10 Hz to 320 Hz.

POLARITY REVERSE Indicates polarity status. Green icon = polarity reversed, white icon = polarity normal.

CHANNEL INPUT DELAY Indicates input delay time. The input delay is continuously-variable in milliseconds from 0-50 ms.

CHANNEL TO BUS ROUTING Determines to which bus or buses the channel audio will be sent. When a channel is routed to a bus as a Send (bus box highlighted blue), the Send Gain value is used. When a channel is sent Pre (green) or Post (orange), the Send Gain value is ignored.

CHANNEL LIMITER Indicates on/off status of channel limiter.

CHANNEL COMPRESSOR Indicates the Compressor position in the audio chain. Pre(fade) or Post(fade). Select to enter Channel Compressor screen.

MUTE Indicates mute status of channel. Blue icon = muted. Toggle mute on/off with the "Tone" switch.

L C R SELECT Indicates the stereo pan position of the channel's contribution to the L/R mix. Orange = selected. Use the */** switch to select. Hold */** switch and rotate select knob for continuous panning positioning. Alternatively, press and hold Select knob, then use */** switch to pan continuously. Rotating the select knob while holding */** will change the balance of Mid, Center and Side when two channels are MS linked.

ARM Toggle the Rtn/Fav switch.

HP PRESET Pressing the HP knob toggles between HP preset and PFL. Can be used to listen to channel panning while viewing the Channel Screen by setting the HP Preset to LR Stereo.

CHANNEL INPUT SOURCE

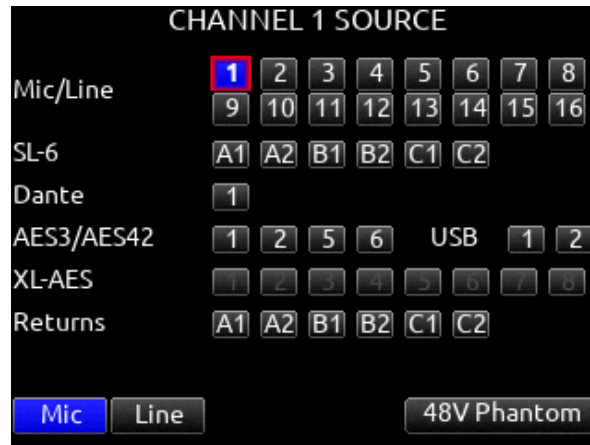

CHANNEL BUS SENDS

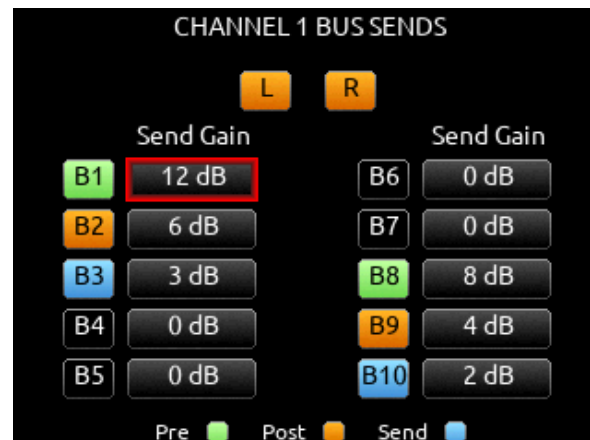

Virtual Keyboard

Action	Function
Rotate HP	Scrolls orange highlight through the keyboard characters.
Press HP	Inserts the highlighted character in text field.
'abc' switch	Quick flick toggles between A-Z and a-z in keyboard.
Hold 'abc' switch	Momentary selection of other case.
Delete	Deletes character to the left of flashing cursor.
Hold Delete	Repeatedly deletes characters to the left of flashing cursor.
Space	Inserts space at the flashing cursor position.
Hold Space	Repeatedly inserts spaces.
Save switch	Saves text and exits screen.
Rotate Select	Moves the cursor to the left or right in the text field.
Quick Press Select	Switches to the Shifted functions: Clear, End, Home, Exit. When shifted functions are active, their text changes to white and the non-shifted functions change to gray.
Clear	Clears text from the text edit field.
End/Home	Moves cursor to end/start of text.
Exit	Exits screen without saving text edits.

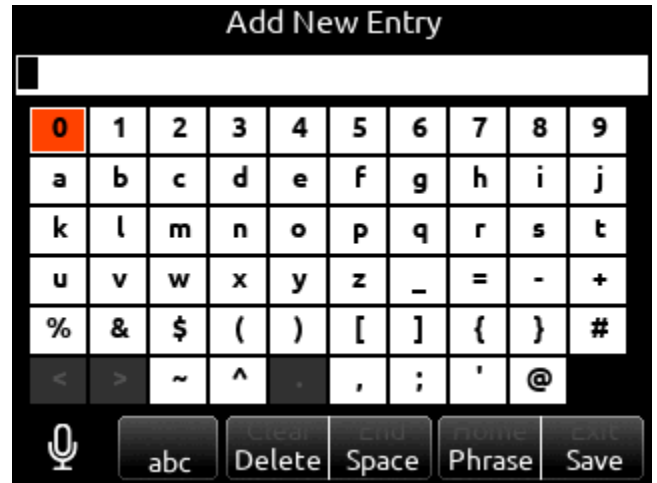

Phrase Manager

Phrases entered in the Phrase Manager are available in all virtual keyboard text editing screens such as scene names, channel names, notes, etc.

CLEAR Clears all phrases.

DELETE Deletes selected phrases.

NEW Creates a new phrase.

EDIT Edits the selected phrase.

INSERT Inserts selected phrase into text.

REPLACE Replaces text with current selected phrase.

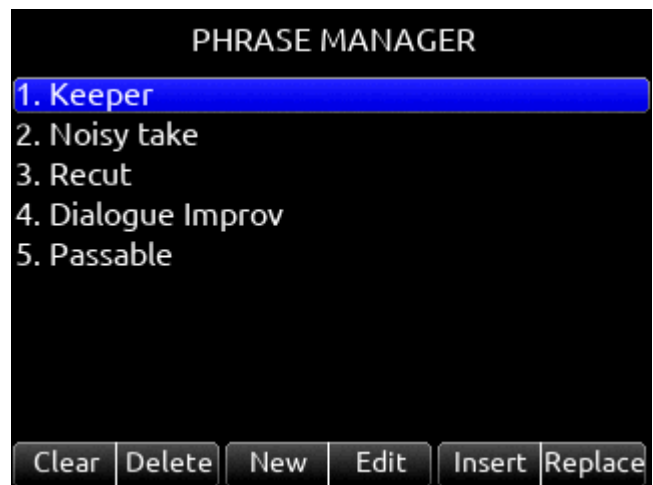

Channel EQ

MIC Selects EQ state and insert location. Indicates where the EQ is inserted into the audio chain. Pre-fade or Post-fade [Off*, Pre, Post]. EQ will apply to bus sends only when applied Pre-fade.

STONE Selects EQ band mode [Bypass*, Active]

/* Selects EQ band. Use Select encoder to adjust frequency and HP encoder to adjust gain of the filter. [LF*, MF, HF] All filters are sweepable from 20 Hz to 20 kHz.

RTN Selects Q (bandwidth) of selected band [0.5 - 10] (use Sel or HP knob to adjust).

FAV Toggles filter type of LF and HF band [Peak, Shelf*].

The Low Cut value is represented by the leftmost value on the graph and is adjustable in the channel screen.

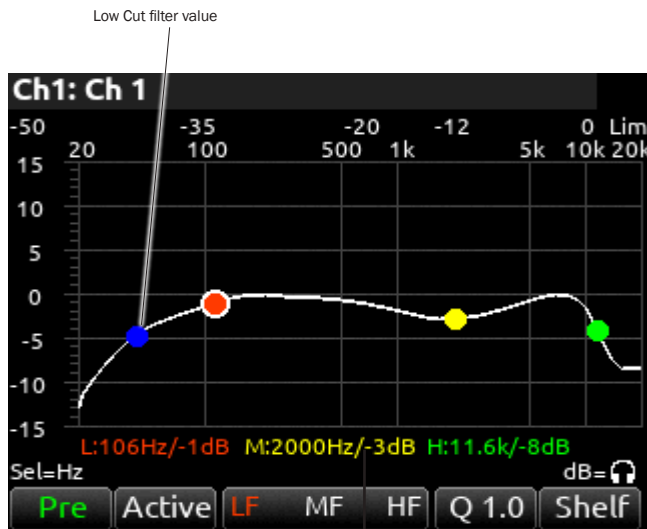

frequency and gain indication

Channel Compression

MIC Selects Compression state and insert location. Indicates where the compression is inserted into the audio chain. Pre-fade or Post-fade [Off*, Pre, Post]. Compression will apply to bus sends only when applied Pre-fade.

Compression will apply to bus sends only when applied Pre-fade.

STONE Selects threshold [0 to -40 dB]

***** Selects Ratio. [1.0:1 to 20:1 in 0.1 steps]

****** Selects Knee. [Hard, Soft]

RTN Selects Attack time [1 to 200 ms in 1 ms steps]

FAV Selects Release time [50 to 200 ms in 1 ms steps, 200 to 1000 ms in 10 ms steps]

Note: Compression can also be applied to Buses.

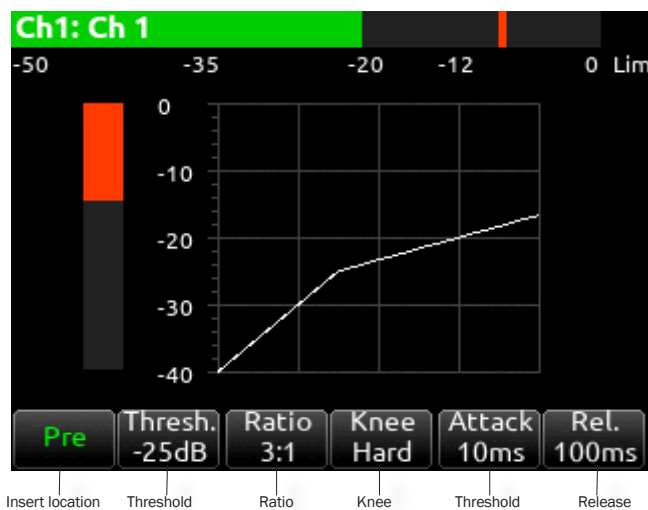

Insert location Threshold Ratio Knee Threshold Release

Channel Copy

Channel Copy provides a mechanism for quickly copying multiple settings from one channel to other channels.

Select the Channel Copy icon to access the Copy Channel screen. Choose which channels to apply the copied settings. Multiple destination channels can be selected. Then choose which settings to copy. Select any combination from EQ, HPF, Compressor, Limiter, Iso, Phase, Pan, Mute, Source, Name, Routing, Delay, and Arm. To copy, toggle the Fav switch.

Note: When copying from channels 17-32 EQ, Phase, and Delay are grayed out and not selectable. These functions are not available on Channels 17-32.

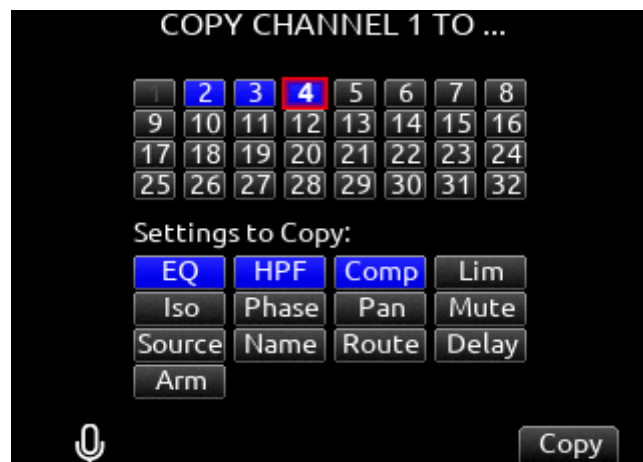

Menus

MAIN MENU

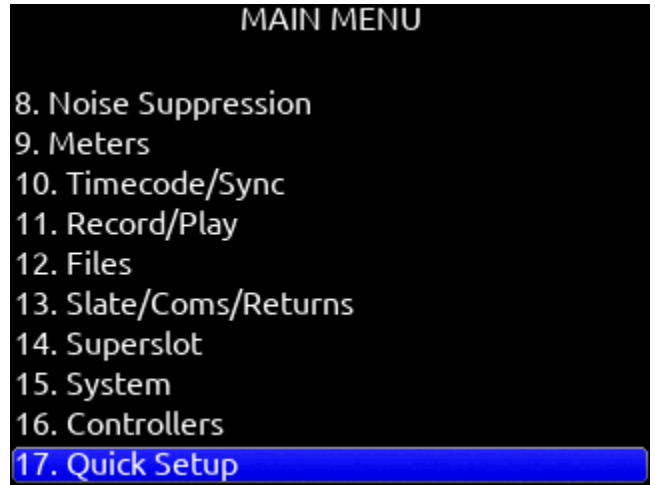
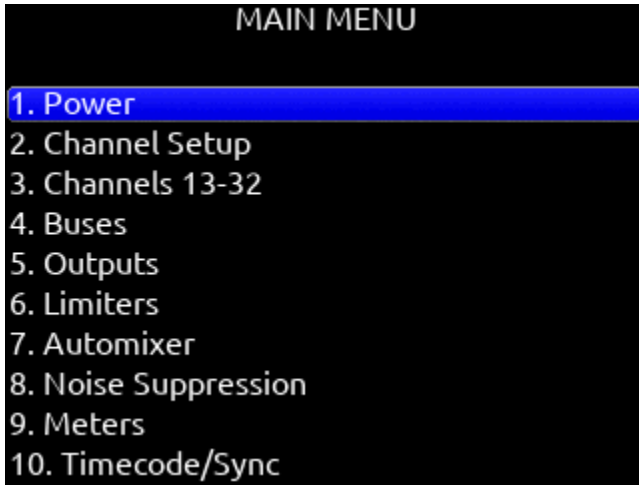

Power

Allows configuration of various power settings.

POWER SOURCE ICONS (Batt1, Batt2, DC1, DC2, TC Batt,) Indicates the power condition of each power source. [Green = normal, yellow = below normal, red = warning]

1. DC1 REF Allows proper power level indicator calibration based upon the type of DC power source used. [12V DC*, 14 V Li-Ion, 12 V Lead Acid, Full Range (10-18 V), Smart Battery], NP1 Data.

2. DC2 REF Allows proper power level indicator calibration based upon the type of DC power source used. [12V DC*, 14 V Li-Ion, 12 V Lead Acid, Full Range (10-18 V), Smart Battery], NP1 Data.

Power Source	Good	Marginal	Low	Shutdown
DC 12 V	12.50 V	11.00 V	10.10 V	9.50 V
Li-Ion 14 V	16.30 V	13.90 V	13.60 V	11.50 V
Lead Acid 12 V	14.00 V	11.50 V	10.30 V	10.20 V
Full Range	18.00 V	12.00 V	10.20 V	9.50 V
Smart Battery	16.00 V	13.30 V	13.00 V	12.70 V
NP1 Data Battery	16.30 V	13.90 V	13.60 V	11.50 V
Li-Ion L-Mounts	8.30 V	7.10 V	6.95 V	6.80 V

3. DC LOSS Selects how the unit should operate when DC power is lost. [Switch to Next Supply*, Turn Off]

4. SMART BATTERY DATA Displays Time Remaining, Percent Remaining, Cycle Count, and Temperature of Smart Battery 1 and Smart Battery 2.

Note: This menu is only displayed when a Smart Battery is connected

4. BATT CHARGING Selects battery charging mode when connected to an external DC source. [Disabled, When Power On, When Power Off, Always] *Battery charging not available when the SL-6 is connected.*

5. USB-A CHARGE PORT Allows charging of compatible external USB devices such as Android tablets. Set to 500 mA or 1.5 A

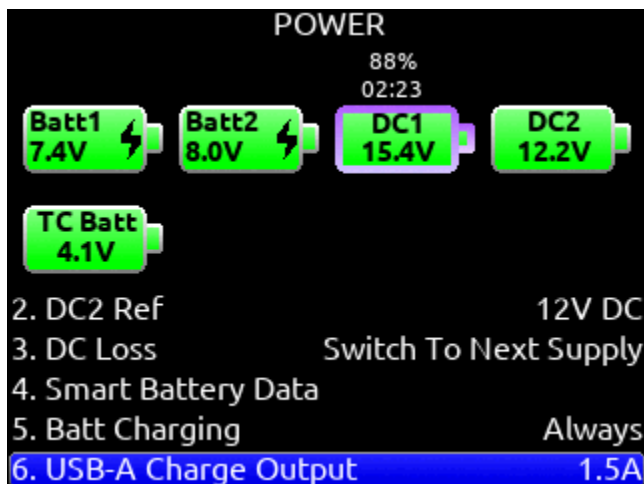
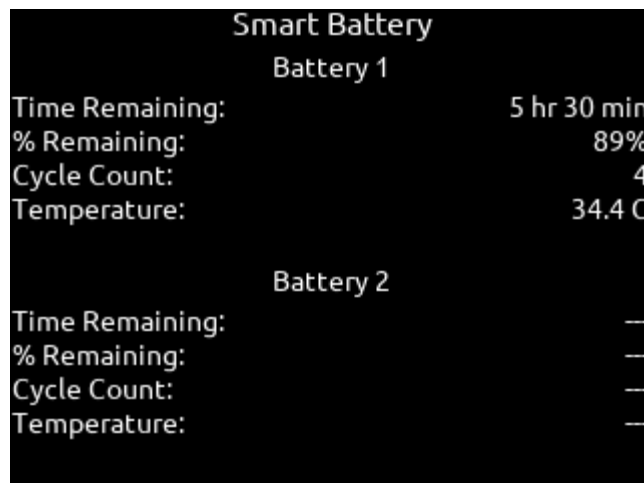
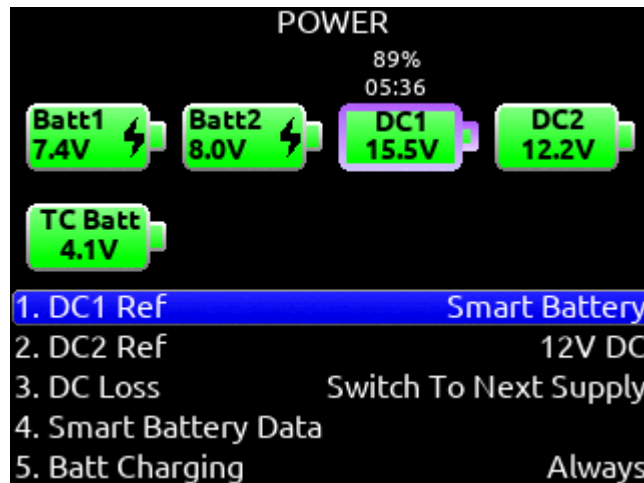

Channel Setup

1. PHANTOM VOLTAGE Selects phantom power voltage for all inputs. [12 V, 48 V*]

2. PFL MODE Selects the source of the PFL feed. [Auto* Pre-fade, Post-fade] Auto = pre-fade if channel is routed to ISO track pre-fade, post-fade if channel is routed to the ISO track post-fade.

3. CHANNEL GROUPING Channel Groups can be set to Off, Trim/Fader, or Fader. Trim/Fader groups allow the smallest channel number in the group to control trim, fader, record arming, limiters, and mutes of all channels in the group. Fader groups act just like Trim/Fader groups but trims remain independent per channel. Groups that are Off retain their channel routings but settings and levels are independent per channel. This allows for quick enabling or disabling of a group without losing group routings.

Trims can only be grouped when all channels of the group share the same gain range. Gain ranges depend on input type routed to a channel. See Channel Screen>Channel Trim Value for more detail.

Four channel groups are possible; channels grouped can only be assigned to one group.

- a. Group 1 [1-16]
- b. Group 2 [1-16]
- c. Group 3 [1-16]
- d. Group 4 [1-16]

4. PFL GAIN A preset amount of gain that is applied to any channel(s) with active PFL.



Channels 13-32

Provides access to channel screens 13-32.

Access is also possible by using the */** + PFL switch shortcuts:

- * + PFL 1-12 = Ch 13-24
- ** + PFL 1-8 = Ch 25-32

Trims, Faders and PFL's for channel's 13 and 14 can be controlled by a combination of the toggle switches beneath the LCD and the Select and HP Knobs. Setup in the System>Toggle Switch Action menu. See the Toggle Switch Action section for information on which of the following options are available for each toggle switch:

CH 13 OR 14 TRIM/PFL (LATCH) Flick toggle then rotate Select to adjust ch 13 or 14 trim. Gain values are displayed in the Home Screen sample rate field. Press Select to PFL. Flick toggle to cancel mode.

CH 13 OR 14 FADER /PFL (LATCH) Flick toggle then rotate Select to adjust ch 13 or 14 fader. Gain values are displayed in the Home Screen sample rate field. Flick toggle to cancel mode

CH 13 TRIM/PFL (MOMENT) Hold toggle then rotate Select to adjust ch 13 trim. Gain values are displayed in the Home Screen sample rate field. Press Select to PFL

CH 14 TRIM/PFL (MOMENT) Hold toggle then rotate HP to adjust ch 14 trim. Gain values are displayed in the Home Screen sample rate field. Press HP to PFL

CH 13 FADER/PFL (MOMENT) Hold toggle then rotate Select to adjust ch 13 fader. Gain values are displayed in the Home Screen sample rate field. Press Select to PFL

CH 14 FADER/PFL (MOMENT) Hold toggle then rotate HP to adjust ch 14 fader. Gain values are displayed in the Home Screen sample rate field. Press HP to PFL

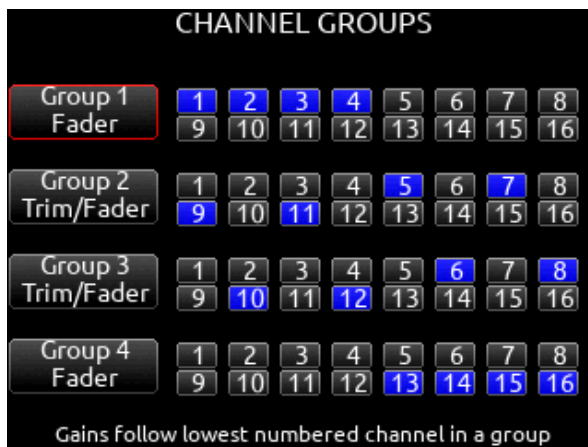

Buses

Selects routing for Buses L,R and 1-10. Access buses via Menu > Buses or by holding Select and toggling a PFL switch. When a bus screen is entered, that bus is solo'd by default in both HP L and HP R. If the bus is linked, the odd bus will be heard in HP L and the even bus in HP R. Toggle between Solo and the current HP preset by pressing the HP encoder.

- 1. BUS METER** Audio level meter for the selected bus.
- 2. LINK *-*** Selects linking for two even-to-odd numbered adjacent buses. Links bus Gain, bus limiters, Mute Coms, and Mute All functions.
- 3. ISO** Any ISO channel contributes to Bus mix. [Green fill in text box = Pre-fade, Orange fill in text box = Post-fade, Light Blue fill in text box = Send gain] Send adjusts the Iso channel send gain to the bus when the selected Iso channel is routed as a 'Send' to that bus (light blue fill in text box). When the selected Iso channel is set to 'Send' (light blue fill), enter the Send field with the * toggle then adjust send gain by rotating the HP encoder.

Tip: Recorded ISOs can be played back via buses. This is useful for playing back alternate ISO mixes on set. By routing the ISOs as bus sends instead of pre or post-fader, you can adjust the ISO mix on playback. Use Buses B3-B10 for this purpose since Bus L, R, B1, and B2 can be recorded and are reserved for playing back their own recorded audio.

- 4. BUS L,R, 1,2** (available on buses 3-10).
- 5. COM** Rtn 1, Rtn 2 (not available on L,R buses).
- 6. RETURN** [A1, A2, B1, B2, C1, C2 (not available on L,R buses).
- 7. SLATE** Activates the slate mic. Slate mic will follow settings from Slate/Coms/Returns menu.
- 8. MORE..** Select to bring up a second page of Bus toggle switch functions including Bus Compressor and Limiter control. Select Rtn toggle to set compressor parameters for the selected bus. Available parameters:

- MIC** Selects Compression On or Off.
- TONE** Selects threshold [0 to -40 dB]
- * Selects Ratio. [1.0:1 to 20:1 in 0.1 steps]
- ** Selects Knee. [Hard, Soft]

- RTN** Selects Attack time [1 to 200 ms in 1ms steps]
- FAV** Selects Release time [50 to 200 ms in 1 ms steps, 200 to 1000 ms in 10 ms steps]
- Select Fav toggle to toggle Limiter On or Off.

9. BUS SEND ON FADER Channel Bus Sends in Bus screens. Use the Sel knob to navigate through the Bus send routing. When an ISO set to Send (highlighted in light blue) is selected, activate the * toggle then rotate the HP knob to adjust the gain of the ISO sent to the bus. Toggle the * switch again to exit Bus Sends on Faders.

10. NAME Opens a keyboard for naming the selected Bus. Bus names appear in bus meter views when a meter view preset has Track Names enabled. Buses L, R, B1, and B2 ripple their names to their respective take metadata track names.

11. NOISEASSIST (NA) or CEDAR SDNX (NX) In Bus L and R screens, use ** toggle to adjust the amount of NoiseAssist or CEDAR sdnx is applied to the selected bus. In Bus 1-10 screens, use Tone to enter More then use ** toggle.

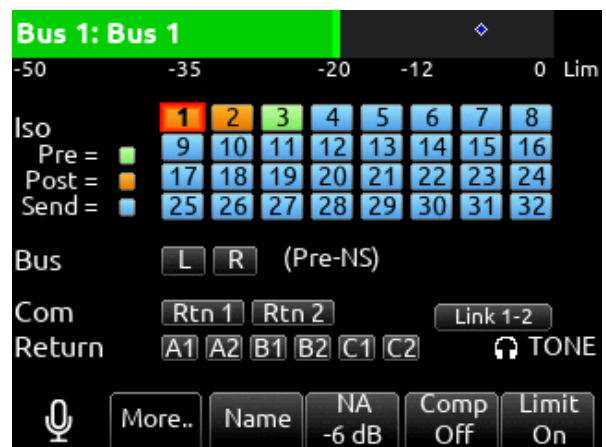
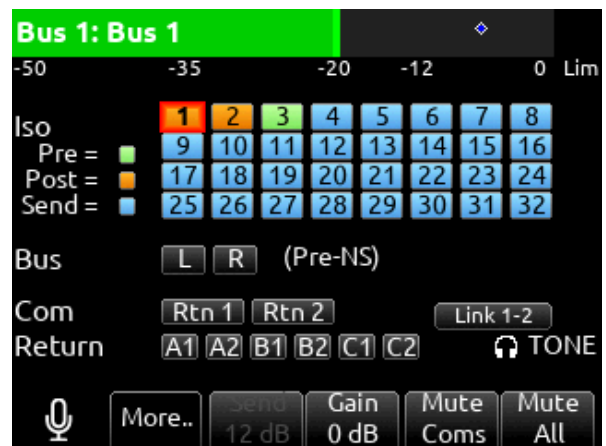

12. GAIN Use ** toggle to select and adjust selected bus gain in 1 dB increments. [Off-16 dB]

13. MUTE COMS Selects muting of Coms 1, 2 sends and returns.

14. MUTE ALL Indicates mute status of bus. Blue icon = muted. Toggle Mute All On/Off with the “Fav” toggle.

Outputs

1. LR, X1-X10 OUTPUT ROUTING

Selects routing for L,R and X1-X10 outputs [L Out, R Out, X1, X2, X3, X4, X5, X6, X7, X8, X9 and X10 Out]

Note: *Only a single source can be routed to an Output. If multiple sources need to be routed, use a Bus.*

NAME Opens a keyboard for naming the selected Output. Output names appear in output meter views when a meter view preset has Track Names enabled.

EDIT Enters the Output screen. The bus can also be entered by pressing the Sel or HP encoder.

A. ISO Selected source will contribute to the Output. (Green = Pre-fade, orange = Post-fade [1-32])

B. BUS [L,R, 1-10, HP-L, HP-R]

C. COM [Rtn 1, Rtn 2]

D. RETURN [A1, A2, B1, B2, C1, C2]

E. RECORD MUTE Selects automatic muting of the output when in Record mode. [Off*, On]

F. STOP MUTE Selects automatic muting of the output when in Stop mode. [Off*, On]

G. PLAY MUTE Selects automatic muting of the output when in Play mode. [Off*, On]

H. DELAY The output delay is continuously-variable in milliseconds from 0-500 ms.

I. GAIN Selects amount of attenuation applied to the output. Toggle the ** to select [0 dB to -50 dB and -inf]

J. LEVEL Selects output level type. [Line, -10, Mic, AES] AES is available for L and R Outputs, AES is not available on X1-X10. See AES Output for more information.

K. MUTE Indicates mute status of output (Orange = muted) Toggle Mute On/Off with the “Fav” toggle.

L. LINK *-* Selects linking for two even-to-odd numbered adjacent outputs. Links gain, mutes, and delays.

2. 10-PIN A OUT ROUTING

Selects routing for 10-Pin A outputs.

A. A1 Selects mix bus for A1 output [L,R, 1-10].

B. A2 Selects mix bus for A2 output [L,R, 1-10].

C. RECORD MUTE Selects automatic muting of the output when in Record mode. [Off*, On]

D. STOP MUTE Selects automatic muting of the output when in Stop mode. [Off*, On]

E. PLAY MUTE Selects automatic muting of the output when in Play mode. [Off*, On]

F. DELAY The output delay is continuously-variable in milliseconds from 0-500 ms.

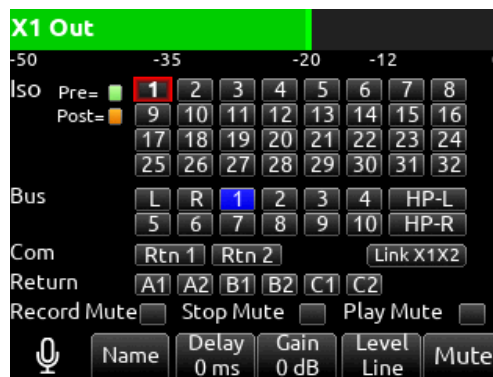
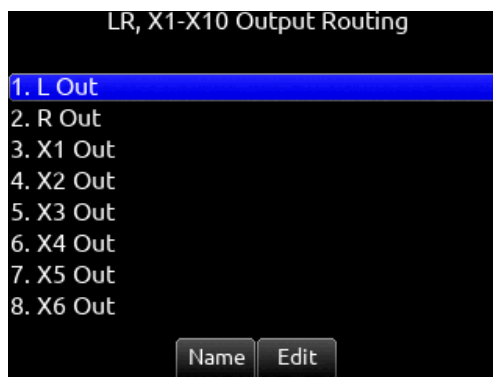

G. GAIN Selects amount of attenuation applied to the output. Toggle the ** to select [0 dB to -50 dB and -inf].

H. LEVEL Selects output level type for A1 and A2. [Line, -10, Mic, AES] Selecting AES changes A1 and A2 from analog to AES Outputs 5-8 and accesses the AES Output Routing menu. See AES Output for more information.

I. MUTE Indicates mute status of bus (Blue icon = muted) Toggle Mute On/Off with the “Fav” toggle

3. 10-PIN C LEVEL

Selects the output level type [Line*, -10, Mic].

4. DANTE

Selects routing for Dante outputs.

A. ISO Any source selected will be routed to the selected Dante output. (Green fill in text box = Pre-fade, Orange fill in text box = Post-fade [1-32])

B. BUS [L,R, 1-10]

C. OUTPUT All sources are selected post-delay. [L,R, X1-X10]

5. USB

Selects routing for USB outputs.

A. ISO Any source selected will be routed to the selected USB output. (Green fill in text box = Pre-fade, Orange fill in text box = Post-fade [1-32])

B. BUS [L,R, 1-10]

C. OUTPUT All sources are selected post-delay. [L,R, X1-X10]

AES OUTPUT Selecting AES as the Level for L, R, or 10-Pin A Outputs accesses the AES Output Routing menus. L Output is used to output AES 1 and 2. R Output is used to output AES 3 and 4. 10-Pin A is used to output AES 5-8.

From the AES Output Routing menus, route any bus to any AES Output using the Select knob.

Change Level back to Line, -10, or Mic to cancel AES Output and return to the L, R, or 10-Pin A Output menus.

10-PIN A AND C

Mates with Hirose RM15TPD-10P(71) connector. Outputs are Active Balanced, output level is selectable in the menus between Line, -10, or Mic level. For unbalanced connections, XLR connectors should be wired pin 1 ground, pin 3 floating, pin 2 positive.

Balanced AES3 Outputs on 10-Pin A connector, 110 ohm, 2 V p-p, AES3 and S/PDIF compatible with RCA adapter.

- 1 - L (+) output (AES 5 on 10-Pin A)
- 2 - L (-) output (AES 6 on 10-Pin A)
- 3 - R (+) output (AES 7 on 10-Pin A)
- 4 - R (-) output (AES 8 on 10-Pin A)
- 5 - R (+) return A
- 6 - n/c
- 7 - L (+) return A
- 8 - n/c
- 9 - ground
- 10 - ground

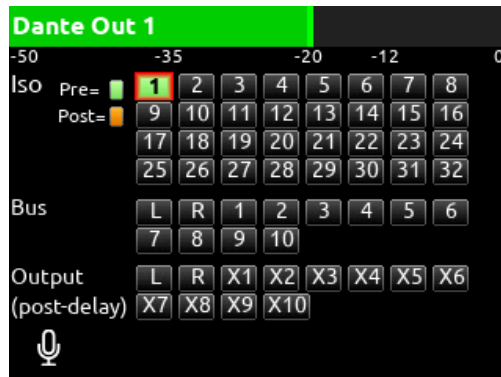

5. HP PRESETS

Selects the list of headphone presets available and allows for editing and creation.

Function	Description
Name	Displays virtual keyboard and allows for naming of the headphone preset.
Edit	Allows selection of routed sources to both HP Left and HP Right. Select HP LEFT or RIGHT and then select desired source. i. ISO- Any source selected will be routed to the selected HP output. Green = Pre-fade, orange = Post-fade. [1-16] ii. Bus- [L,R, 1-8] iii. Com- [Rtn] iv. Return- [A1, A2, B1, B2]
Mono	Selects monophonic monitoring of selected HP-L/HP-R sources.
MS	Selects monophonic monitoring of selected HP-L/HP-R sources.
Unlist	De-selects a preset in the list preventing it from being listed in the HP Preset menu (press HP knob on Home Screen).
List	Selects a preset in the list allowing it to be listed in the HP Preset menu (press HP knob on Home Screen).
Fav	Selects a favorite preset. The name turns green when selected. The “Fav” switch recalls this HP preset when in the Home Screen.

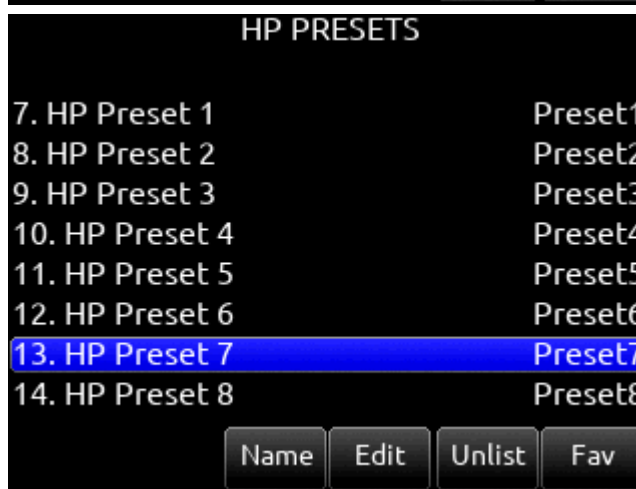
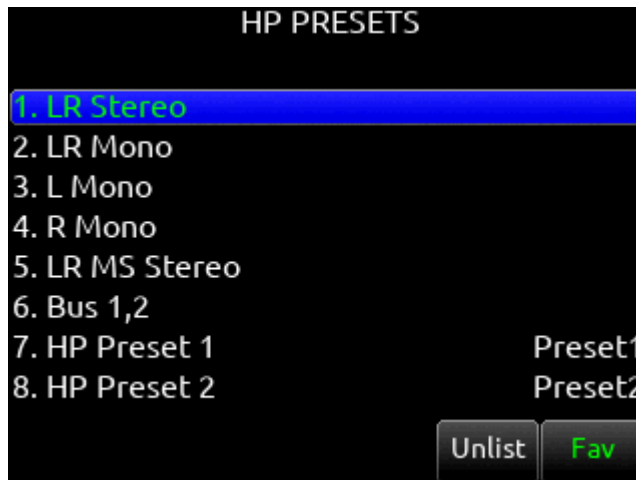

Limiters

CHANNEL LIMITERS QUICK SETUP Selects the channel limiters on/off status globally. [All On*, All Off]

BUS LIMITERS QUICK SETUP Selects the bus limiters on/off status globally. [All On*, All Off]

CHANNEL THRESHOLD Selects the threshold at which the channel limiters activate. -6 dBFS* [-2 to -12 dBFS]

CHANNEL RATIO Selects the ratio of the limiter. [Inf:1, 10:1, 12:1, 14:1, 16:1, 18:1, 20:1*]

CHANNEL KNEE Selects the channel limiter Knee. [Hard, Soft]

CHANNEL ATTACK Selects the channel limiter attack time [1*-200 ms]

CHANNEL RELEASE TIME Selects the release time of the limiters in 10 ms increments. 100 ms* [50-1000 ms]

BUS THRESHOLD Selects the threshold at which the bus limiters activate. -3 dBFS* [-2 to -12 dBFS]

CHANNEL THRESHOLD Selects the threshold at which the channel limiters activate. -6 dBFS* [-2 to -12 dBFS]

BUS RATIO Selects the ratio of the limiter. [Inf:1, 10:1, 12:1, 14:1, 16:1, 18:1, 20:1*]

BUS KNEE Selects the bus limiter Knee. [Hard, Soft]

BUS ATTACK Selects the bus limiter attack

BUS RELEASE TIME Selects the release time of the limiters in 10 ms increments. 100 ms* [50-1000 ms]

BUS THRESHOLD Selects the threshold at which the bus limiters activate. -3 dBFS* [-2 to -12 dBFS]

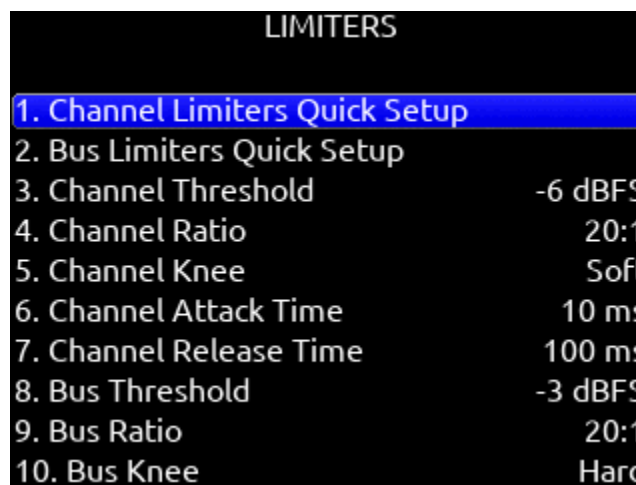

Automixer

Selects the Automixing mode and the channels included in the automixer group(s).

MODE Selects the Mode of Automix [MixAssist, Dugan Automixer] and whether it is disabled* or enabled.

Note: Set a toggle shortcut or mapped controller button to enable/disable the selected automixer mode to allow you to quickly compare the effect of the automixer being on or off.

RING LED INDICATION Set to On to display automix meter levels on the ring LEDs. Set to Off if you prefer to only see automix levels in the LCD meter views.

CHANNEL SELECTION Selects which of channels 1-16 are included into the automix group(s). A channel can also be selected for automix from channel screens 1-16. Enter a channel screen 1-16 then use the Select encoder to scroll to and toggle the Automix on or off for that channel. Purple text is On, white text is Off.

Note: Automixer is only available with sample rates of 47952, 48000, and 48048 Hz.

Note: If a channel is enabled for automixing, it forces post-fade routing of that channel to Bus L and R in the Channel Bus Sends menu and the Bus L and R routing menus.

DUGAN AUTOMIXER MODE

Dugan gain display bars are overlaid on top of the channel signal meters. The top 15 dB of the meter scale is shared between Dugan gain display bars and audio signal metering. Dugan gain display bars range from 0 dB (at the top, aligned with 0 dBFS, no attenuation) to -15 dB (max attenuation). The -15 dB value is indicated by a purple horizontal graticule mark near the top of a channel's signal meter when that channel is enabled for Dugan in Menu>Automixer.

There are two independent Dugan processing groups, Bus L and Bus R. Channels 1-16 can be routed to Bus L, Bus R, both equally (Center), or both unequally (L or R pan increments) by using a channel's pan control.

To show which Dugan group the channel is in, the Dugan gain display bar is left-aligned for fully L, right-aligned for fully R and center-aligned for any other pan value. When a channel is routed to both Dugan groups (Bus L and R), the center-aligned gain display bar shows the least attenuated value.

The Channel Screen shows the Dugan gain display bar overlaid within the horizontal channel meter. The Dugan gain display scale and indication is the same as in the main meter screen.

The ring LEDs for ch 1-12 show Dugan gain for ch 1-12. The ring LEDs begin to glow purple at 15 dB attenuation and increase in intensity at 0 dB attenuation.

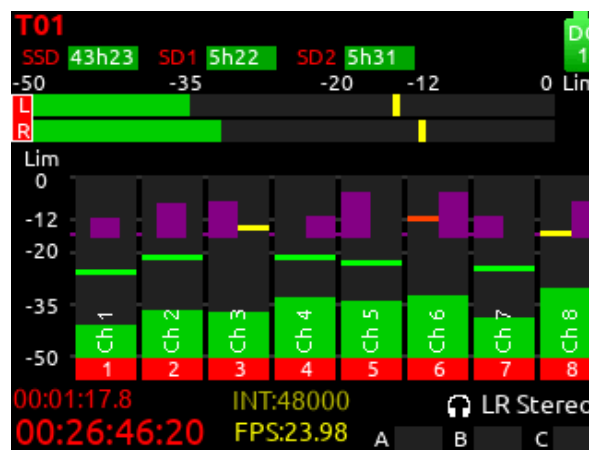
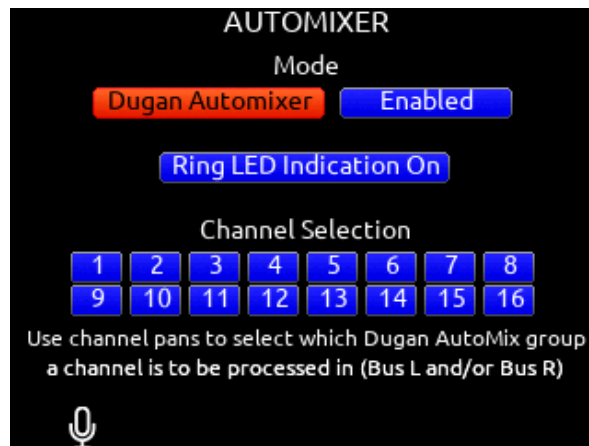

MIXASSIST MODE

MIXASSIST OFF-ATTENUATION MIXASSIST OFF-ATTENUATION

Sets the amount of attenuation applied to inactive input channels.
Range: 6 dB to 40 dB. Default: 15 dB.

When a channel is active (not attenuated), it's ring LED (channels 1-12 only) and LCD meter view channel indication illuminate green.

There are two independent MixAssist processing groups, Bus L and Bus R. Channels 1-16 can be routed to Bus L, Bus R, both equally (Center), or both unequally (L or R pan increments) by using a channel's pan control.

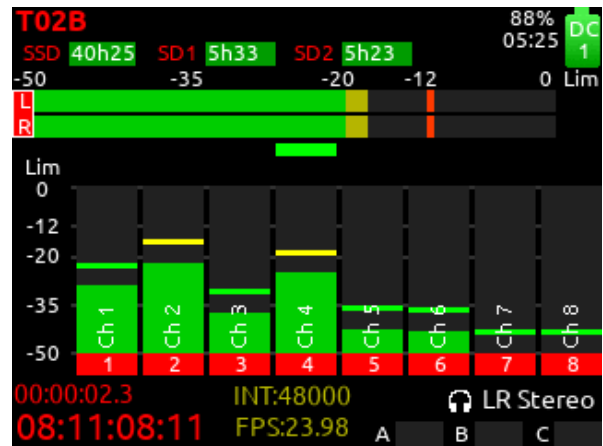

Meters

Selected Preset

METER PRESETS 1-12

SL-2 RECEIVER OVERVIEW Selects the Peak Hold Time and Meter range for the SL-2 Receiver Overview audio level meters. Menu not available unless an SL-2 is connected.

A. PEAK HOLD TIME Selects the peak hold time for the meter preset. [Off, 1*-5s., Infinity]

B. METER BALLISTICS Selects the ballistics for the meter preset. VU: The meter bar ballistics emulate the 300 ms attack and 300 ms release times of a VU meter. VU meter ballistics correspond closely to how the human ear perceives loudness. This provides a good visual indication of how loud a signal will be.

VU + Peak Hold: Same as the VU setting but with the addition of a peak hold segment. See Peak Hold Time above.

PPM: The meter bar ballistics have instantaneous attack time and slow release time. Ideal for monitoring actual signal peaks. The release time can be set using the PPM Release Time setting.

PPM + Peak Hold: Same as the PPM setting but with the addition of a peak hold segment. See Peak Hold Time above.

C. PPM RELEASE TIME Selects the Release Time for the PPM meter ballistics. [400 ms* to 1600 ms in 200 ms steps]

D. METER RANGE Selects the range of the meters from bottom to top of scale. [50 dB*, 40 dB, 20 dB]

E. METER VIEW Selects the meters to be viewed in the current preset. [LR,1-8*, LR,9-16, LR,17-24, LR,25-32, LR,1-16, LR,17-32, LR,1-12, LR,13-24, LR,1-32, 1-8 (Horizontal), 9-16 (Horizontal), 17-24 (Horizontal), 25-32 (Horizontal), LR,1-8 (Horizontal), LR,9-16 (Horizontal), LR,17-24 (Horizontal), LR,25-32 (Horizontal), LR,Outputs, LR,Buses, LR>Returns, LR,Buses (Horizontal), LR,Outputs (Horizontal), LR,1-8,B1-2,X1-2, LR Out,B1-4,X1-4, LR Out,B1-4,X1-4(Horizontal), LR,1-3 (Horizontal)]

F. TRACK NAMES Selects whether track name, output name, and bus name are displayed in the meter preset. [Enabled*, Disabled]

G. GRAY METERS Selects gray meter when record disarmed. [When disarmed*, Off]

SL-2 RECEIVER OVERVIEW Selects the Peak Hold Time and Meter range for the SL-2 Receiver Overview audio level meters. Ballistics and PPM release time are taken from the last selected Meter Preset. Menu not available unless an SL-2 is connected.

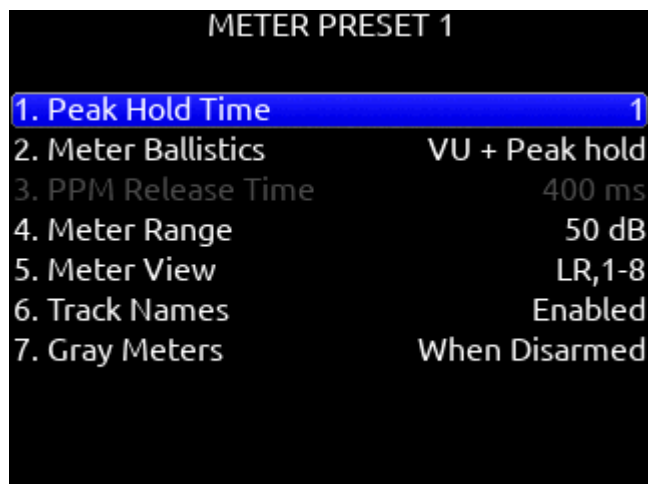
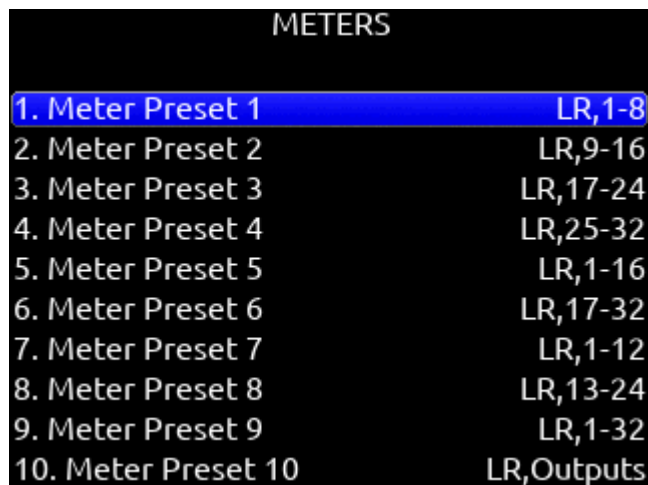

Meter View Menu Shortcuts

WHEN IN LR, OUTPUTS AND LR, BUSES METER VIEWS Turn the Select knob to scroll to an output or bus. Pressing the Select knob acts as a shortcut to that outputs or bus routing screen.



Timecode

TIMECODE MODE Selects the timecode mode of operation. [Off, Record Run, Free Run*, Free Run Auto Mute, Free Run Jam Once, 24 Hour Run (ToD), 24 Hour Run Auto Mute, Ext TC, Ext TC - Auto Record, Ext TC Continuous, Ext TC Cont. - Auto Record]

FRAME RATE Selects the current frame rate. [23.98*, 24, 25, 29.97 ND, 29.97 DF, 30 ND, 30 DF]

HOLD OFF Selects the amount of time incoming Timecode needs to be valid prior to entering record when in auto-record mode. [0.0*-8.0 seconds in steps of 0.1 sec.]

JAM Indicates the Received TC, Generator TC and the calculated difference between the two. Received and Generator UBits are shown. Jamming to external TC and UBits is supported. Jam TC- Toggle Rtn/Fav switch to jam to external TC.

JAM A20-MINI This menu is available when an A20-Mini is connected via USB-A to the Scorpio. Displays the timecode and frame rate of Scorpio and A20-Mini along with the calculated difference. Toggle the Jam A20- Rtn/Fav switch to jam the A20-Mini.

SET GENERATOR TC Provides the ability to start rolling internal TC from a manually entered value in the format of HH:MM:SS:ff.

SET GENERATOR UBITS Provides UBits manual and automatic entry. [U=User entered UU:UU:UU:UU*, mm:dd:yy:UU, dd:mm:yy:UU, Use External] Use Rtn/Fav toggle to exit.

LEMO OPTIONS Selects pin-2 and pin-5 options for TC Lemo connector.

- a. Pin-2 - [TC In*, WCK In, WCK Out]
- b. Pin-5 - [TC Out, WCK Out]

DISPLAY MODE Selects whether to display Big Timecode or Big A-Time.

SYNC REFERENCE Selects current sync reference for all transport modes (record, stop and play). [Internal*, Word Clock, LTC In, AES 1,2 (XLR 1), AES 5,6 (XLR 6)] Ring LEDs flash yellow while locking to the selected sync reference. Once locked, the LEDs will stop flashing. Should the LEDs flash indefinitely, the selected sync reference has not been detected. Locking can take up to 30 seconds.

Note: Expansion port accessory AES inputs cannot be used as a sync reference source.

HOLDING TC WHILE POWERING DOWN When the Scorpio is shut down and external DC (TA4 connector) is not connected, the Scorpio holds timecode accurately for four hours before resetting, provided the internal timecode backup battery is charged.

The internal timecode battery charges when:

- 1) The 8-Series is on and powered by L-Mount batteries, TA4 DC In, or the SL-6.
- 2) The 8-Series is off, power is connected to one of the TA4 DC Ins, and the Power>Batt Charging option is set to Always or When Power is Off.

Note: The timecode battery does not charge when the unit is Off and power is connected to the SL-6..

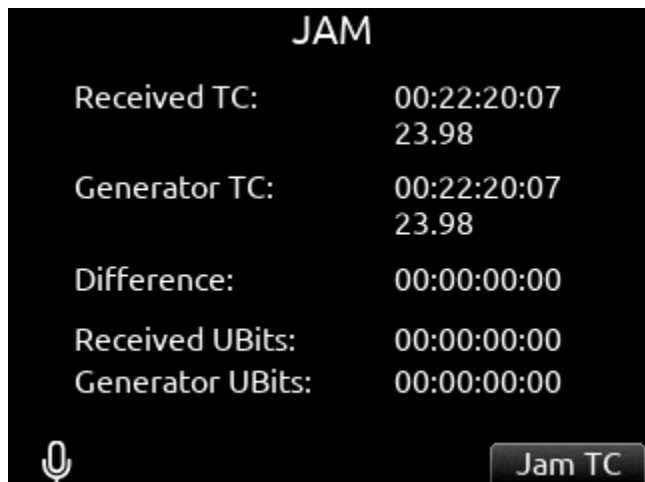
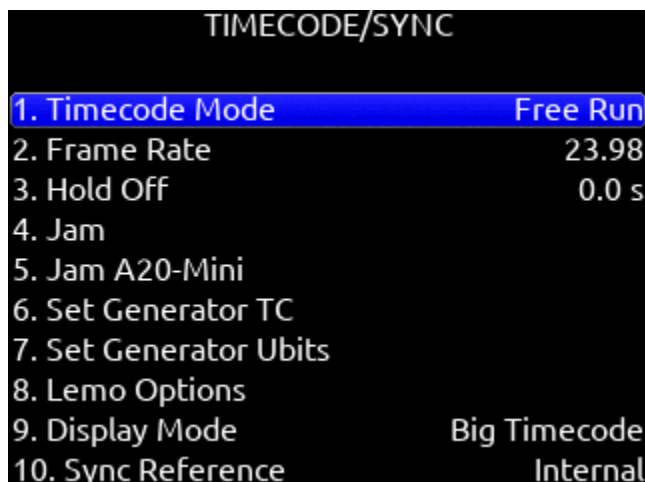

Record/Play

SAMPLE RATE Selects the current sample rate. [44100, 47952, 48000*, 48048, 96000, 192000 Hz]

BIT DEPTH Selects the current bit depth. [16, 24*]

PRE-ROLL TIME Selects the amount of Pre-roll recording. Adjustable in 1 second increments. *0 s [0-10 s]

POST-ROLL TIME Selects the amount of Post-roll recording. Adjustable in 1 second increments. [0-10 s] If a recording is stopped prematurely, press record within the post-roll time. The machine will continue to record into the original file. Useful for when directors call 'cut' prematurely. During the post-roll period, the transport joystick ring LED shows orange. Pressing stop again during the post-roll period cancels the post-roll and stops recording.

TRACK TO MEDIA MENU Selects the sources for each recording media as well as the type of file recorded. Tracks may be routed to media to be recorded as AAC (LR or Bus 1,2 only), WAV Mono, or WAV Poly files. (Green text box= WAV Mono file, Blue text box= WAV Poly file, Orange text box = AAC)

Select whether Mono or Poly WAV files are recorded in standard BWF or RF64 format using the Rtn/Fav toggle. BWF WAV files seamlessly auto-split to a new file when the max BWF 4GB file size is reached. Split files can be joined in any DAW. RF64 WAV files have a much higher maximum file size and do not require auto-splitting.

Note: Most DAWs support WAV RF64. Some NLEs do not. It is recommended to check NLE compatibility before using RF64.

Also: 8-series Q-marks are not supported when RF64 is selected.

Tracks L/R and Bus1/2 can be recorded as AAC audio files. (Orange text box). AAC files are ideal for transcription.

Select the AAC Bit Rate using the */** toggle switches. [32, 64, 128, 192, 256 kbps]

Select the WAV Format using the Rtn/Fav toggle switches. RF64 allows for WAV files larger than 4 GB.

- A. SSD- [ISO, L/R, Bus1/2, ALL]
- B. SD1- [ISO, L/R, Bus1/2, ALL]
- C. SD2- [ISO, L/R, Bus1/2, ALL]

To differentiate between the ISO and L/R mix poly files:
 "ISO" is appended to the end of the ISO poly file's filename.
 "LR" is appended to the end of an L/R poly file's filename.
 "B1B2" is appended to the end of a Bus 1/2 poly file's filename.

- * Up to 36 track recording supported with sampling rates 44.1- 96 kHz. Up to 18 track recording at 192 kHz.
- ** Monophonic file recording up to 48.048 kHz.
- *** AAC file format when recording at 48 kHz.

DEFAULT PLAYBACK DRIVE Selects the drive for playback. [SSD, SD1, SD2]

PLAYBACK TAKE/FILE FROM TAKE/FILE LIST Enter the take or file list and select a take or file with either knob. Pressing play will playback the selected take or file.

ARMING/DISARMING DURING RECORDING All channels can be armed/disarmed while recording. This creates a seamless split to a new file or files. The split takes will be suffixed with an incrementing alphabetic character. I.e. A, B, C...

AUTO-SPLIT Takes that are auto-split due to the 4 GB limit of BWF format are also suffixed using the same A, B, C...incrementation.

RECORD SPLIT Takes that are split when pressing record during recording increment the file's take number.

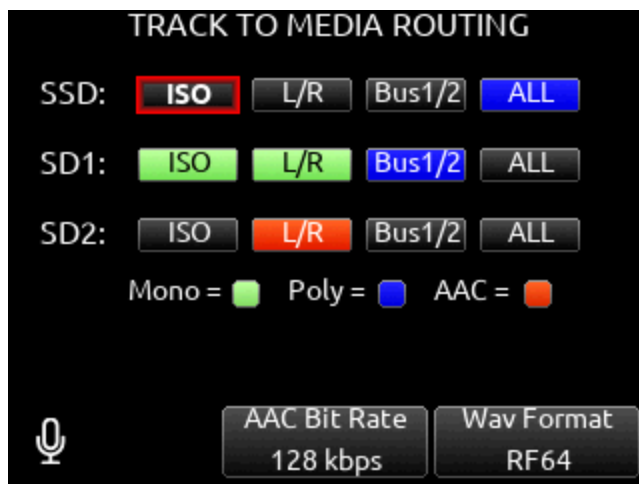
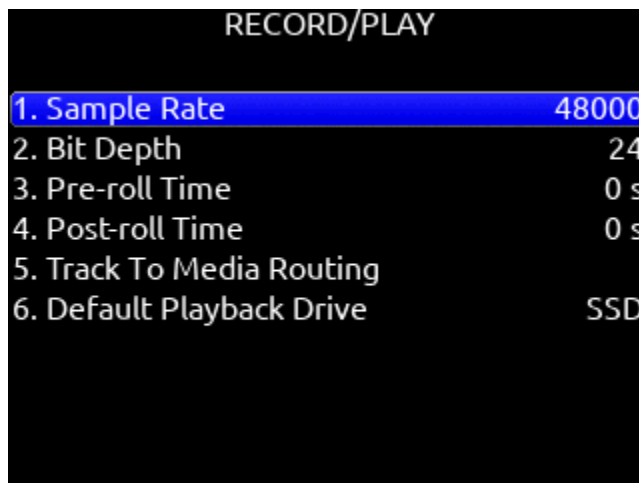

Q-marks

Use Q-marks, (also known as cue marks) to mark points of interest within a recording. Q-marks can be added and deleted during recording, playback, pause, or scrub mode when viewing the Home screen. Once added, they can easily be located to during playback on the 8-series. Q-marks are also embedded in the WAV file and can be read by audio editing applications such as Reaper and Adobe Audition.

Note: Q-marks are only supported when using the BWF WAV format, not the RF64 WAV format.

Note: Q-marks in auto-split files (due to BWF 4GB max size) are not supported.

To add a Q-mark, hold Select and press >>.

The Q-mark number is displayed in blue at the top of the meter view to the right of the take name. Each time a new Q-mark is added, the Q-mark number is incremented. (Q01, Q02, Q03)

To delete a Q-mark, hold Select and press <<.

Q-marks can also be added and deleted using Toggle Switch Action shortcuts, Midi mapped buttons, and USB Keyboard buttons 'Q' and 'delete'.

LOCATING TO Q-MARKS DURING PLAYBACK, PAUSE, OR

SCRUB:

To locate to the next Q-mark, press >>. If there is no next Q-mark, pressing >> will locate to the end of the take and will pause playback.

To locate to the previous Q-mark, press <<. If there is no previous Q-mark, pressing << will locate to the beginning of the take.

Tip: To check the last few seconds or minutes of a long take, Press >> after the last Q-mark has been passed. This will pause playback at the end of the take. Then rewind or reverse scrub to the point of interest and press play.

Files

TAKE LIST

Enters the Take List. The Take List shows a running list of recorded takes in chronological order with most recent at the top. Various details of each take are indicated on the right side of the display: TC (timecode), Duration, Media, Folder, Scene, Take, Date, and Notes. From this list, takes may be selected for metadata editing by using the Rtn/Fav toggle or pressing the HP knob to access the Take Edit Menu.

Press Menu + HP knob as a shortcut to the Take List. Highlight any take in the Take List, then press play to play it back.

RECORD FOLDER

Record Folders are containers for storing recorded audio files and sound reports. They can be nested up to three levels deep. Set a record folder as 'current' to determine where audio files and sound reports are stored.

Record folders are unified across all three media (SSD, SD1, SD2) - any actions taken on a record folder (NEW, SET CURRENT, Delete Folder, Create Sound Report) affect that record folder on all three media.

To select an existing record folder or to create a new record folder, go to the Take List and use the */** toggles to access the REC FOLDER menu. By default, the RECORD FOLDER menu displays a list of record folders at root. Navigate to nested folders by highlighting a record folder and pressing the Sel/HP knob. To navigate back up the folder hierarchy, press Menu or select "\.." at the top of the folder list. The screen's title identifies the folder path.

To create a new record folder in the folder level being viewed, select NEW (Tone toggle). The newly created record folder is automatically set as the current record folder.

Select the Folder Type in the popup that appears. There are three types of record folder - Custom, Project, and Daily.

CUSTOM Files are stored in a custom-named folder; the Custom folder name is embedded as Tape metadata in the recorded audio files.

PROJECT Files are stored in a folder with a name determined by the Project name entered in the Take List > Next take Edit Screen. The Project folder name is embedded as Tape metadata.

DAILY Files are stored in a folder whose name is in the format yyYmmMdd. When a Daily folder is selected, the Date is embedded as Tape metadata.

When a daily folder is selected as the current record folder, a daily folder popup is displayed when the first recording after midnight is completed. The daily folder popup displays the following message: "Store this recording and subsequent recordings in the previous day's folder or store in a new daily folder? [Previous], [New]"

- Select Previous to continue recording takes in the previous days folder.
- Select New to record in a new Daily folder.

*Tip: To store new recordings in the root directory, highlight 'None' in the Root screen then select the */** toggle (SET Current). When 'None' is selected, the date is embedded as Tape metadata.*

Any existing record folder can be set as the "current" record folder. Use the SET CURRENT */** toggle to set the highlighted folder as the "current" record folder. The current record folder can be easily identified by the orange "[current]" tag following the folder name.

Tip: To easily find the current record folder when it is nested within another folder, navigate the path indicated by orange record folder names.

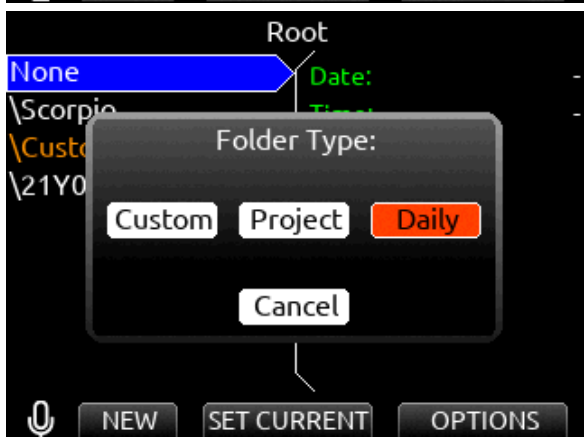
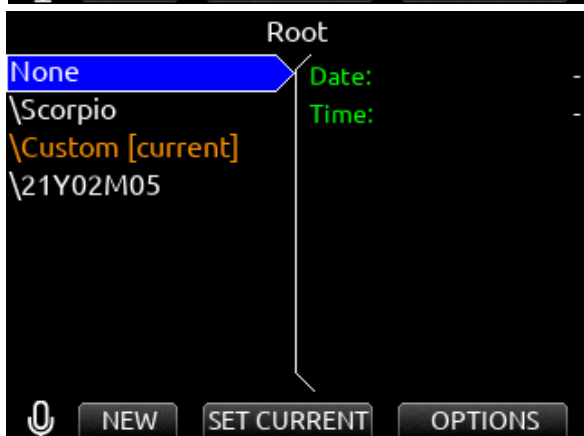
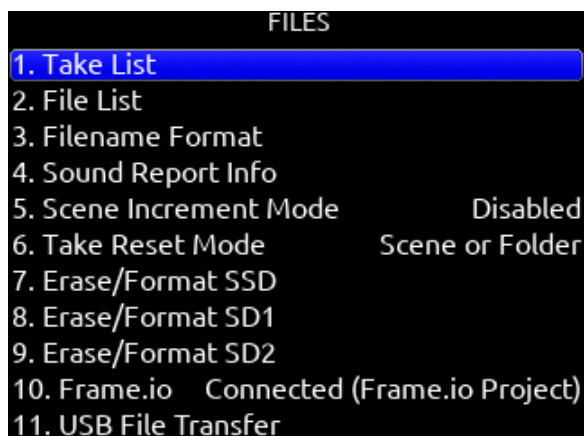

Tip: The Record Folder menu can also be accessed by selecting 'Folder' from the Take List>Next Take Edit screen. This also shows the current record folder's full path.

Tip: Program a Toggle Switch or map a shortcut for one-touch access to the Record Folder menu.

RECORD FOLDER OPTIONS

Highlight a record folder then select OPTIONS using the Rtn/Fav toggle. The following options are available:

CREATE SOUND REPORT Creates a sound report for the selected folder (not including its sub folders) on all 3 media. If there are no audio files in the selected folder, a 'No Takes Found' popup is displayed.

The sound report's filename format is [Date]_[RecFolderName]_Media.CSV, where Date is a 6-digit string based on the Date Format setting in the System>Time/Date menu and Media = ' ' for SSD, '_1' for SD1, and '_2' for SD2.

For example: Rec Folder name = ROLL8, Date = 13th Aug, 2020 would appear as:

- 081320_ROLL8.csv (on SSD)
- 081320_ROLL8_1.csv (on SD1)
- 081320_ROLL8_2.csv (on SD2)

DELETE FOLDER Permanently deletes the selected record folder and all its contents including sub folders on all three media. This action cannot be undone.

When the monophonic WAV file format is selected (in the Record/Play > Track to Media Routing menu), all mono files created for a take follow the name of the take and are stored in a take folder within the selected record folder.

TAKE EDIT MENU

1. Notes: Edit notes for the selected take. Maximum 200 characters including Sticky Notes.
2. Sticky Notes (next take only): edit sticky notes that are automatically prepended to subsequent takes. Maximum 50 characters.
3. Scene: Edit scene name. Maximum 50 characters.
4. Take: edit Take Number.
5. Circle (current or previous takes only): circle a take. Prepends "@" symbol to take name.
6. Project Edit Project name. Maximum 20 characters. This will become the record folder name if Project is selected as the Folder Type.
7. Delete (current or previous takes only): moves a selected take to a drive's Trash folder.
8. Rename: Renames a take's name. Project, Scene, and Take iXML/bEXT metadata are also updated provided renaming does not change or delete the scene and/or take separator characters.
If a take is renamed and the edit doesn't conform to the current Filename Format setting (with designators), it becomes a freeform take name and metadata will not be updated.
If a take is renamed and the edit conforms to the current Filename Format setting (with designators), the metadata is updated even after renaming a freeform take name.
If a take is renamed and the edit contains a letter following the take designator, the take number metadata is updated only with the numbers immediately following the designator.
9. Track Names: Edit track names. Maximum 20 characters. A10-TX and A20-Mini transmitter names can be optionally used to populate the associated isolated track names. See SL-2 and SL-6 Option Use Track Names for more.

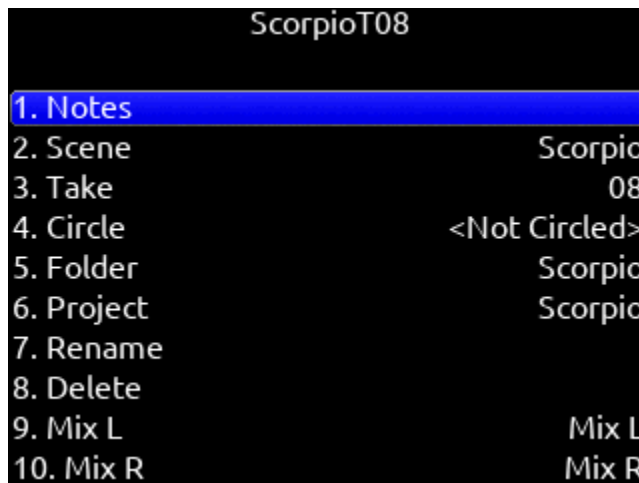
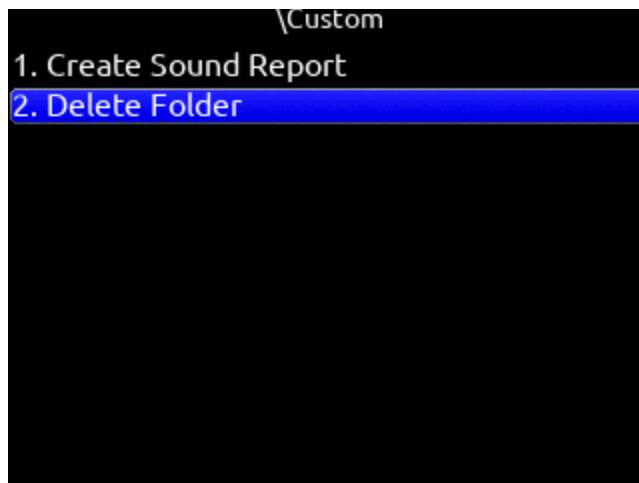

The '+' prefix is added if an existing take is edited such that it would duplicate the name of another existing take in the same record folder. The 'A' suffix is added if the NEXT take's name is edited such that when recording is started, it would duplicate the name of an existing take in the same record folder.

FILE LIST

Menu>Files>File List enters the File List. The File List displays the Scorpio's internal SSD and SD cards and their contents. Various details of each drive, folder, and WAV file are indicated on the right side of the display: TC, FPS, duration, format, tracks, date, time, size.

The File List is also accessible from the Take List by pressing the Tone Switch.

Highlight any WAV file in the File List, then press play to play it back.

FILE LIST OPTIONS FOR FILES

COPY FOLDER/FILE Provides support for copying Folders and Files between drives from the File List's Options Menu.

DELETE FOLDER/FILE Delete Folders and Files from the File List's Options Menu.

FILE LIST OPTIONS FOR FOLDERS

CREATE SOUND REPORT Creates a CSV sound report for the selected folder's takes.

The sound report's filename format is MMDDYY_[RecFolderName] [Media].csv where Media = ' ' for SSD, '_1' for SD1, and '_2' for SD2

Rec Folder name = ROLL8, Date = 13th Aug, 2020 would appear as:
 081320_ROLL8.csv (on SSD)
 081320_ROLL8_1.csv (on SD1)
 081320_ROLL8_2.csv (on SD2)

Tip: It is possible to simultaneously create sound reports on all three media for the current Record Folder by setting a Toggle Switch Action, Controller Midi Mapped button, or GPIO to the 'Create Sound Report' function.

EMPTY TRASH Empties the trash folder.

EMPTY FALSE TAKES Empties the false takes folder.

ERASE/FORMAT Formats the selected drive.

SD1 and SD2 cards can be given a custom volume name during the format process.

FILENAME FORMAT Selectable naming conventions for recorded files. Selectable between Scene (Slate) T,+,- Take, or Project ;,%, = Scene (Slate) T,+,- Take.

SOUND REPORT INFO Selects the various content for each field of a sound report.

SCENE INCREMENT MODE Defines whether a scene name shall be incremented numerically or alphabetically when the scene increment shortcut is used. When set to 'Character', the last scene character will increment from A through Z, but skipping 'I' and 'O' to avoid being confused with '1' and '0'.

TAKE RESET MODE Selects when a Take Number shall reset to 1. Options are: Never, Scene Change, Folder Change, Scene or Folder Change.

ERASE/FORMAT SSD Select to erase/format the internal SSD.

ERASE/FORMAT SD1 Select to erase/format SD1. Enter a custom volume name for the SD card when prompted.

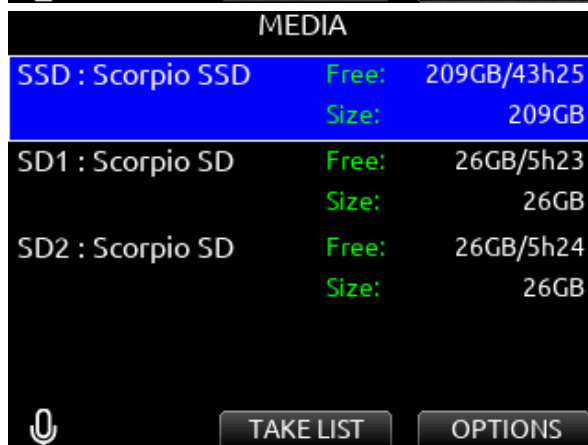

ERASE/FORMAT SD2 Select to erase/format SD2. Enter a custom volume name for the SD card when prompted.

FRAME.IO Allows connection to Frame.io and setup. See Frame.io for more details.

USB FILE TRANSFER Enters USB file transfer mode. Files may be transferred between a Mac or PC and Scorpio via USB-C port. *When in USB file transfer mode, playback, record and controller functions are suspended.*

Tip: Headphone gain can be adjusted while in File Transfer mode allowing HP volume change while listening to computer USB audio when selected as a source for headphones.

Frame.io

Frame.io C2C (Camera-to-Cloud) is a service that allows automatic upload of Scorpio recorded files to the cloud as soon as they are closed. Recorded files upload even while recording new ones. To upload to Frame.io, a Frame.io account and/or invitation to add your Scorpio as a Cloud Device to a Frame.io Project is required. Visit <https://www.frame.io/c2c> for further information.

TO CONNECT TO FRAME.IO

1. Establish an Internet connection by connecting the Scorpio's Ethernet port to a router or LTE hotspot. The Scorpio's Network IP address is configured automatically from the router or hotspot's DHCP server. The IP address is displayed in the Files>Frame.io menu. Depending on the network environment, it may take a few minutes for the Scorpio to receive an IP address.

Wait for the Network IP address to be displayed in the Files>Frame.io menu.

Once the IP address is displayed, the Scorpio will automatically check Internet connection status. The Frame.io Setup menu's Internet Status field will display 'Online' if successfully connected to the Internet. If the Scorpio displays a valid Network IP address but the Internet Status displays 'Offline', check that the router or hotspot is connected to the Internet.

If the IP address shows 0.0.0.0 (no IP address), check the Ethernet connection.

2. Connect the Scorpio as an authorized Cloud Device to the Frame.io Project.

- A. From the Frame.io iOS app, a Frame.io Project with Cloud Device Integration enabled needs to be created.
 - i. In the Frame.io Project's Cloud Devices Tab, select 'Set up new device'.
 - ii. Select 'Device ready to connect'. Frame.io app displays 'Enter the device pairing code'.
- B. From the Scorpio Files>Frame.io menu, select Connect (*/** toggle).
 - i. Within 30 seconds (depending on connection speed and traffic), Scorpio displays the 6-digit device pairing code. Enter this 6-digit code in the Frame.io iOS app's 'Enter the device pairing code' screen, then tap the 'Authorize' button. Wait for authorization to complete.

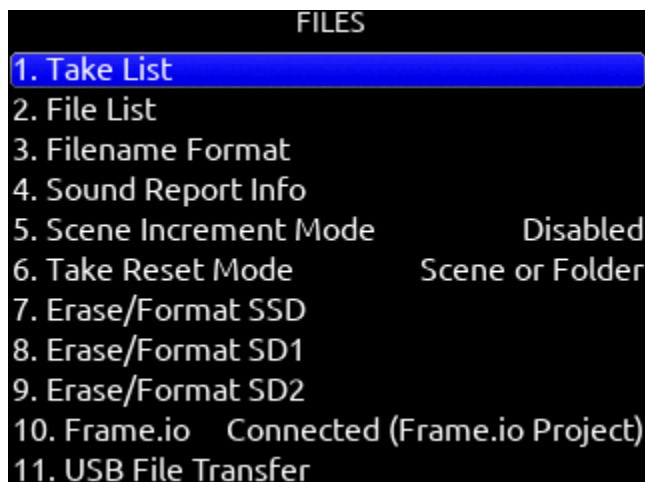

- ii. If connection to the Frame.io Project is successful, “Connection to Frame.io successful” is displayed on the Scorpio’s screen. Click OK and confirm that the ‘Current Project’ field displays the name of the Frame.io Project. Dashes are displayed if the Scorpio is currently not connected to any Frame.io project.
 Tip: From any Meter View, you can easily confirm that you are actively connected to a Frame.io project. This is indicated by a light blue rectangle box surrounding the selected Frame.io Upload Drive.

The Scorpio is now ready to upload files to Frame.io.

TO DISCONNECT FROM FRAME.IO

From the Scorpio menu Files>Frame.io select Disconnect (*/** toggle). Disconnecting de-authorizes the Scorpio as a contributing Cloud Device to the Frame.io project.

If a take is already in the process of uploading when disconnecting from Frame.io, a popup appears with the options to disconnect now or after the upload of the take in progress completes. Disconnect Now will leave an incomplete file and therefore unusable take on the Frame.io server.

- It is not necessary to reconnect to a Frame.io Project after power cycling the Scorpio. Reconnection to a Frame.io Project is only necessary after disconnecting or when the Project expires. To find out more about Project expiration, visit Frame.io.
- The Scorpio can only be connected to one Frame.io Project at a time. Disconnect from the current Frame.io project before attempting connection to the new project.

UPLOAD DRIVE

Choose which tracks (ISO, L/R, Bus 1/2) and file type (Mono, Poly, AAC) to upload to the Frame.io Project. First, in the Scorpio Record/Play>Track to Media Routing menu, select tracks and file type for the SSD, SD1, and SD2. Then select Files>Frame.io> Upload Drive and choose whether to upload from SSD, SD1, or SD2.

UPLOAD MODE

Choose whether to automatically upload all takes in the current record folder, new takes in the current record folder, manually upload takes, or pause upload to Frame.io.

REC FOLDER (MIRROR) Automatically uploads all takes in the Scorpio Record Folder to Frame.io

REC FOLDER (NEW TAKES) Automatically uploads only takes that are recorded after entering this mode to Frame.io.

TAKE (MANUAL) Manually upload individual takes from the Scorpio Take List to Frame.io. When set to Take (Manual), an ‘Upload to Frame.io’ option is available in a take’s Edit screen.

PAUSED Pauses uploading of takes to Frame.io. If a take is already in the process of uploading when the upload is paused, a popup appears with the options to pause the upload now or after the upload of the take in progress completes. Pausing Now will leave an incomplete and therefore unusable take on the Frame.io server. The take will be reuploaded to Frame.io when selecting another Upload mode.

When in Paused mode, ‘P’ flashes in the meter view drive field and the Scorpio remains connected to the Frame.io Project.

Note: If file upload is interrupted due to loss of power or loss of Internet connection, the Scorpio automatically reconnects and reuploads the file upon reconnection to Frame.io.



MONITORING FRAME.IO UPLOAD STATUS

METER VIEW

Blue rectangle box surrounding drive: Drive is set to upload and is connected to Frame.io
 Flashing '→' icon on the drive icon: Drive currently uploading files to Frame.io.
 Flashing 'P' on the drive icon: Upload Drive paused.

TAKE LIST

The Take List uses different colors to identify a take's upload status.

Take List Left Pane:

- White take: Take not uploaded or queued for upload.
- Orange take: Take is uploading to Frame.io.
- Purple take: Take uploaded to Frame.io.

Take List Right Panel > Media:

- White SSD, SD1, or SD2: Take not uploaded to Frame.io from drive.
- Orange SSD, SD1, or SD2: Take is uploading to Frame.io from drive.
- Purple SSD, SD1, or SD2: Take uploaded to Frame.io from drive.

FRAME.IO WEB BROWSER AND IOS APPS

From the Frame.io Web Browser or iOS app you can:

- Confirm file upload
- Playback uploaded Scorpio WAV or AAC files
- Add comments to files for collaboration purposes
- Rename, Delete, Move, and Copy uploaded files
- Share and download files plus more

For more information, visit Frame.io

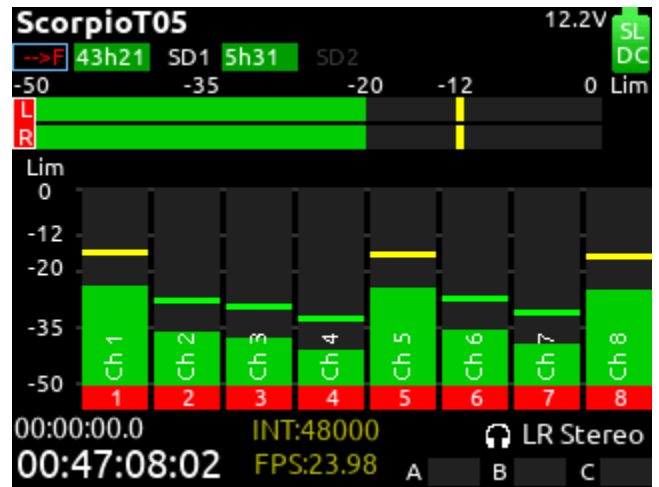

TAKE LIST	
ScorpioT05 [next]	TC: 00:31:17:00
ScorpioT04	Duration: 00:00:03:00
ScorpioT03	Media: SSD SD1 SD2
ScorpioT02	Folder: Scorpio
ScorpioT01	Scene: Scorpio
T05	Take: 04
T04	Date: 03/19/21
T03	Notes:
T02	

At the bottom of the table are buttons for FILES, REC FOLDER, and EDIT.

Slate/Coms/Returns

SLATE/COM MIC SOURCE Selects the slate and com mic source. [Off, Int Mic*, Ext Mic, Ext 12 V Mic]

SLATE/COM MIC GAIN Selects the gain for the slate/com mic. [-10-20 dB in 1 dB steps for the internal mic, 0-60 dB in 1 dB steps for the external mic].

SLATE ROUTING Selects the destination(s) for the slate mic.

- a. Track- [1-32]
- b. Output- [L,R, X1-X8, A1,A2]
- c. Bus- [L,R, 1-10]
- d. HP- [HP-L, HP-R]
- e. Duck Bus Prgrm By: [0- -40 dB, -inf]
- f. Duck HP Prgrm By: [0- -40 dB, -inf]

COM SEND 1 ROUTING Selects the destination(s) for Com Send 1.

- a. Output- [L,R, X1-X8, A1,A2]
- b. Bus- [L,R, X1-X8]
- c. HP- [HP-L, HP-R]
- d. Duck Bus Prgrm By: [0- -40 dB, -inf]
- e. Duck HP Prgrm By: [0- -40 dB, -inf]

COM SEND 2 ROUTING Selects the destination(s) for Com Send 2.

- a. Output- [L,R, X1-X8, A1,A2]
- b. Bus- [L,R, X1-X8,
- c. HP- [HP-L, HP-R]
- d. Duck Bus Prgrm By: [0- -40 dB, -inf]
- e. Duck HP Prgrm By: [0- -40 dB, -inf]

COM RTN1 GAIN Selects the gain for Com Rtn 1 in 1 dB increments. [0-30 dB]

COM RTN2 GAIN Selects the gain for Com Rtn 2 in 1 dB increments. [0-30 dB]

RTN A GAIN Selects the gain for Rtn A in 1 dB increments. [0-30 dB]

RTN B GAIN Selects the gain for Rtn B in 1 dB increments. [0-30 dB]

RTN C GAIN Selects the gain for Rtn C in 1 dB increments. [0-30 dB]

DUCK BUS PROGRAM BY Ducks all audio sent to the bus by a user defined amount.

DUCK HP PROGRAM BY Ducks all audio sent to headphones by a user defined amount.

When sending coms or slate signal to outputs the program routed to that output is replaced by the com or slate signal.

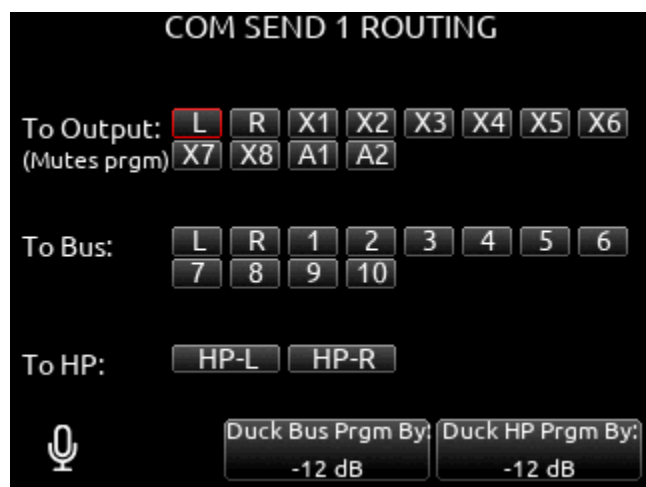
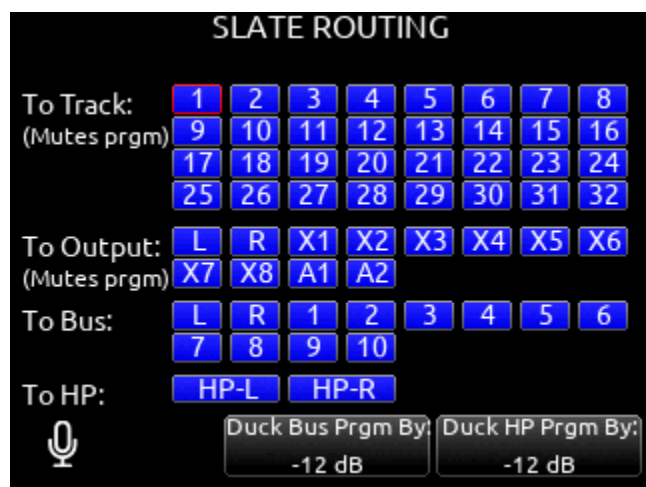
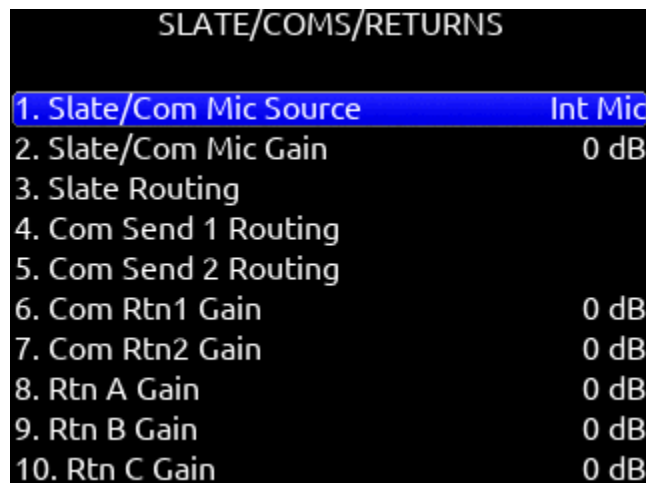

SuperSlot

When combined with Scorpio, the SL-2 and SL-6 SuperSlot wireless accessories offer integrated control of SuperSlot compatible receivers, monitoring, powering, and RF distribution for multiple channels of wireless audio.

Selecting the SuperSlot menu item (or shortcut Meter+HP) navigates directly to the Rx Overview screen. This screen varies based on which SuperSlot accessory is attached to Scorpio.

See SL-2 Receiver Overview and SL-6 Receiver Overview for more details.

The SuperSlot menu is grayed out and inaccessible unless either a Sound Devices SL-2 Dual SuperSlot Wireless Module or a SL-6 Powering and Wireless System is attached to the Scorpio.

The SL-2 or SL-6 Receiver Slot Power or the 8-Series power must be cycled after performing any action that causes a receiver to reboot. Powering receivers on and off from the receiver's user interface is not supported.

SL-2

The SL-2 is a two slot-in wireless receiver integration system that easily mounts to the top panel of any 8-Series mixer-recorder. It accepts UniSlot and SuperSlot™ wireless receivers from a variety of manufacturers. Power to the SL-2 and receivers is supplied by the 8-Series Mixer-Recorder – no external DC connector is needed on the SL-2. Analog or digital audio is sent from the receivers into the mixer-recorder via the expansion port, reducing messy cabling for power and audio connectivity.

The SL-2 offers antenna distribution to slot-in receivers, spreading out the placement of antennas for better RF performance. Additionally the SL-2 allows for control of smart antennas and includes two filtered antenna outputs to external receivers via MCX ports. The rear panel of the SL-2 is equipped with two TA3 connectors for an additional four inputs of AES3 audio and two 4-pin Hirose DC Outputs, each supplying up to 500 mA.

Up to eight channels of audio can be routed from the SL-2 to the Scorpio. The eight channels can be comprised of audio from dual or quad channel slot in receivers and/or the four AES inputs.

The SL-2 mounts to the Scorpio via the multi-pin expansion port located on the top panel. Please refer to the SL-2 User Guide for panel descriptions and installation instructions.

WARNING! *To avoid potential hardware damage, turn off power to the SL-2 slot prior to removing and inserting receivers. Slot power can be turned off in Menu>System>Expansion Port, Menu>SuperSlot>Options>Slot Power, or by powering off the 8-Series Mixer-Recorder.*

Supported SuperSlot receivers for use in the SL-2 are:

- Audio Ltd. A10-RX
- Lectrosonics SRb, SRc, SRc-941, SRb5P (Slot A only), SRc5P (Slot A only)
- Sennheiser EK6042 (does not support scan)
- Shure ADX5D
- Sony DWR-S03D
- Wisycom MCR42
- Wisycom MCR54

SL-2 SHOWN ON THE 833



POWERING THE SL-2

The SL-2 is powered by the Scorpio via the Expansion Port. No additional power source is needed to power the SL-2. To activate the SL-2, set the System>Expansion Port menu to On. Save power when the SL-2 is not in use by setting the Expansion Port menu to Off. When the Expansion Port is set to Off, the SuperSlot menu is grayed out.

ROUTING SL-2 SOURCES TO CHANNELS

The SL-2 has a total of 12 sources, up to eight channels of wireless from the two slots (A1-A4, B1-B4) plus four channels of AES from the rear panel TA3 ports. Only eight of these sources can be used at any one time. AES 3 and 4 cannot be selected when a slot receiver output is analog.

To route an SL-2 Source to a channel, access a channel's source screen and select from A1-A4, B1-B4, AES 1-4. When A1-A4, B1-B4 are selected as source, use the */** toggle as a shortcut to the selected receiver's setup screen.

For SL-2 A1-A4, B1-B4, and AES 1-4 sources, channel trim gain range is -20 to 50 dB.

When the A10-RX is receiving signal from the A20-Mini, the trim gain of the associated 8-Series channel is 0 to 60 dB. See GainForward.

RF OVERLOAD LEDS Each antenna input on the front panel of the SL-2 has an associated LED that displays incoming RF level status. Red = approaching RF overload threshold of the SL-2
Orange = approaching overload threshold of digital wireless systems
Off = no overload
To disable the LEDs go to SL-2 Options>Antenna LEDs and set to Off.

SL-2 RECEIVER OVERVIEW Select the SuperSlot menu to enter the SL-2 Receiver Overview screen which displays information for all receivers connected to the SL-2. Hold Meter then press the HP knob to quickly access the Receiver Overview screen.

A1-A4, B1-B4 Use the Select knob to scroll and select an SL-2 channel to access the individual Receiver Setup screen. See Receiver Setup Screen for more details.

POST-TRIM CHANNEL METERING Displays the post-trim audio level of the Scorpio channel receiving audio from the SL-2 source. *When the SL-2 source is not routed to a Scorpio channel, no signal is displayed on the meters.*

RF FREQUENCY Displays the frequency of the receiver in MHz.

TRANSMITTER BATTERY LEVEL Displays the battery level of the paired transmitter, if applicable.
Green = over 50%
Yellow = over 20%
Orange = over 10%
Red = less than 10%.

TRANSMITTER RECORD STATUS Indicates the record status of the paired transmitter, if applicable. Red = recording

TRANSMITTER STATUS BOX (A10-RX only)
A10-TX: Indicates paired transmitter Mute, Limiter, and Audio Overload status.
A20-Mini: Indicates paired transmitter Mute status. The Limiter and Audio Overload indicator are displayed for the 8-Series channel receiving the A20-Mini signal.
Blue with 'M' = Transmitter Mute On
Yellow with 'L' = Limiting
Red with 'O' = Audio Overload

RF LEVEL HISTORY Displays the RF level over a period of time. Duration of RF History is set in SL-2 Options>RF History Duration parameter from 30 to 600 seconds in 10 s steps, default duration is 30 seconds. The taller the green bar, the healthier the received RF signal. A red bar signifies receiver RF overload (A10-RX only).

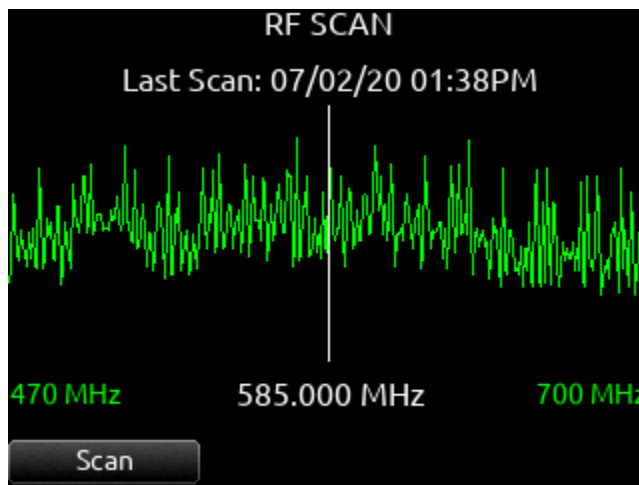
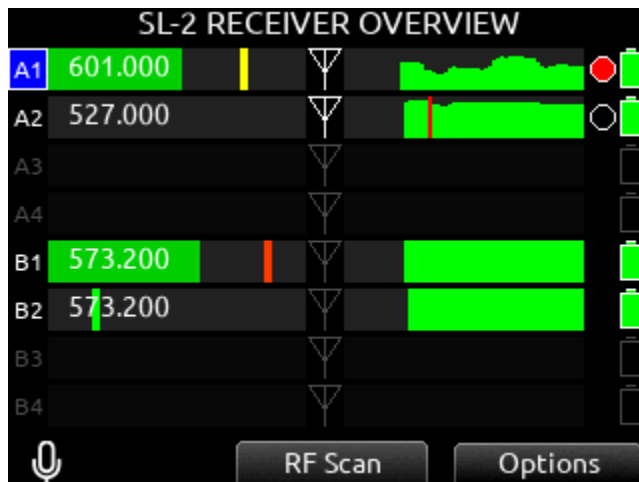

RX ANTENNA ICON Indicates RF signal status.

- Solid white = locked to antenna signal
- Flashing white = antenna signal unlocked
- Solid Red = antenna signal overload
- Gray = no receiver detected

RF SCAN Instigates an RF Scan of the environment using both slot receivers. Use the */** toggle switch to start the scan.

OPTIONS Access the SL-2 Options menu by using the Rtn/Fav toggle switch.

SL-2 OPTIONS

Provides access to various SL-2 settings including:

RECEIVER SLOT POWER Each slot can be individually turned On/Off to save power when not in use.
Powering receivers on and off from the receiver's user interface is not supported.

DC OUTPUTS Enable/disable DC Outputs 1 and/or 2.

ANTENNA A/B POWER (BIAS) Provides 12 V DC bias power for active or smart antennas.

ANTENNA ATTENUATION Apply attenuation to reduce the possibility of RF overload. Select from 0 to -18 dB in 6 dB steps.

ANTENNA FILTER Select the SL-2's front end filter to reduce the likelihood of out-of-band RF noise affecting range. Select from Wideband, 470-614 MHz, 542-694 MHz, 606-770 MHz, 770-960 MHz, 1240-1260 MHz.

ANTENNA LEDS Antenna LEDs can be toggled On*/Off.

REMOTE ANTENNA CONTROL Enables/disables Remote (Smart) Antenna Control.

REMOTE ANTENNA SETUP Configures the various settings for connected remote (smart) antennas. The menu is grayed out if Remote Antenna Control is Off and/or no remote antenna is detected. A remote antenna requires bias power. The SL-2 supports the Wisycom LFA-B-F1 antenna.

a. Antenna A/B Gain: Sets gain of Antenna A or B in 1 dB steps. [Off, Bypass, -12 to 27dB]

b. Antenna A/B Filter: Sets the filter type of Antenna A or B. [WB (Selected in Freq field: 410-810, 410-700, 410-600, 470-810, 470-700, 470-600, 510-810, 510-700, 510-600); NB (940-960MHz, freq is fixed at 940-960 and cannot be changed)]

c. Antenna Frequency: Sets the filter freq of Antenna A or B. [When Filter is set to NB, Frequency is fixed at 940-960 and cannot be changed. When Filter is set to WB, Freq can be set to 410-810, 410-700, 410-600, 470-810, 470-700, 470-600, 510-810, 510-700, 510-600. When Filter is set to Tunable, Filter Frequency can be adjusted in 40 MHz blocks from 410-450 to 690-730 in 1 MHz steps.]

d. Antenna A/B Settings: Provides access to additional Antenna A or B settings.

1. Name: Displays name of Antenna A/B.
2. Display Brightness: Sets Antenna A/B display brightness in increments of 1. [1-10]
3. Display Color; Sets Antenna A/B display color. [White, Black]
4. Display timeout: Sets the duration of Antenna A/B display timeout in steps of 1 second. [5 to 240 seconds]
5. Display Rotate: Sets the rotation of the Antenna A/B display. [0 or 180]
6. LED: Sets Antenna A/B LED activity. [On or Off]
7. Version Info: Displays system information about the Wisycom LFA-B-F1.

SL-2 OPTIONS	
1. Receiver Slot Power	
2. DC Outputs	
3. Antenna A Power (Bias)	Off
4. Antenna B Power (Bias)	Off
5. Antenna Attenuation	0 dB
6. Antenna Filter	Wideband
7. Antenna LEDs	Off
8. Remote Antenna Control	Off
9. Remote Antenna Setup	
10. RF History Duration	30 s

ANTENNA CONTROL	
1. A Gain Mode	Normal
2. A Gain	0 dB
3. A Filter Type	Fixed
4. A Filter Freq	410-810 MHz
5. A Settings	INTERIOR
6. B Gain Mode	Normal
7. B Gain	0 dB
8. B Filter Type	Fixed
9. B Filter Freq	410-810 MHz
10. B Settings	TEST

ANTENNA A SETTINGS	
1. Name	INTERIOR
2. Display Brightness	10
3. Display Color	Black
4. Display Timeout	240 s
5. Display Rotate	0
6. LED	On
7. Version Info	

RF HISTORY DURATION Sets the duration of the RF HISTORY plot. Select from 30 to 600 seconds in 10 second steps, default duration is 30 seconds.

USE WIRELESS NAMES When On the name associated with the receiver channel is automatically applied to the isolated track receiving the signal. This feature is supported by the Audio Ltd. A10-RX and the Shure ADX5D.

SL-6

When combined with Scorpio, the SL-6 offers easy integration of multiple channels of wireless connectivity, mixing, recording and power management in a lightweight and easy to use package. The SL-6 simplifies interconnection between the Scorpio and multiple channels of wireless by accepting three dual-channel slot-in receivers providing a total of six separate audio feeds. Easily attaching to Scorpio's top panel, the SL-6 offers all powering and audio interconnection for standard slot-in receivers and additional control and monitoring when used with SuperSlot compatible receivers. The SL-6 also distributes RF from external antennas to the receivers, creating a more efficient, compact configuration.

The SL-Riser accessory is required for connection of the SL-6 to Scorpio. See the SL-Riser installation instructions here: <https://www.sounddevices.com/sl-riser-assembly/>

The Scorpio must be powered via the SL-6 DC or NP-1 power source to use the SL-6.

WARNING! Remove all batteries and disconnect DC inputs from both the SL-6 and Scorpio prior to connecting the SL-6 to the Scorpio. Failure to remove power could result in damage to the hardware.

Supported SuperSlot receivers for use in the SL-6 are:

- Audio Ltd. A10-RX
- Lectrosonics SRb, SRc, SRc-941, SRb5P (Slot B or C only), SRc5P (Slot B or C only)
- Sennheiser EK6042 (does not support scan)
- Shure ADX5D
- Sony DWR-S03D
- Wisycom MCR42
- Wisycom MCR54 (2 channels per receiver only)

SL-6 FRONT PANEL

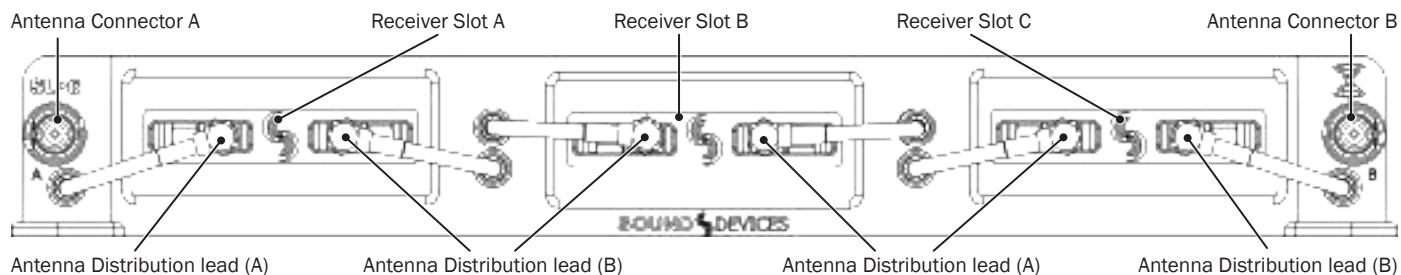

Feature	Description
Receiver Slots	Each slot accepts one (single- or dual-channel) SuperSlot or Unislot receiver. The connection provides power to the receiver and connects the receiver's audio output directly to the Scorpio.
Antenna Distribution leads	SMA connectors with right-angle adapters are used to connect receivers to the SL-6 antenna distribution system.
Antenna Connectors	BNC connectors are used for attaching external antennas to the SL-6 antenna distribution system. <i>Use BNC to SMA adapters, included with the SL-6, for antennas with SMA connectors.</i>

SL-6 LEFT PANEL

The left panel of the SL-6 provides the NP-1 battery compartment, which accepts NP-1 batteries (14 V, Li-ion).

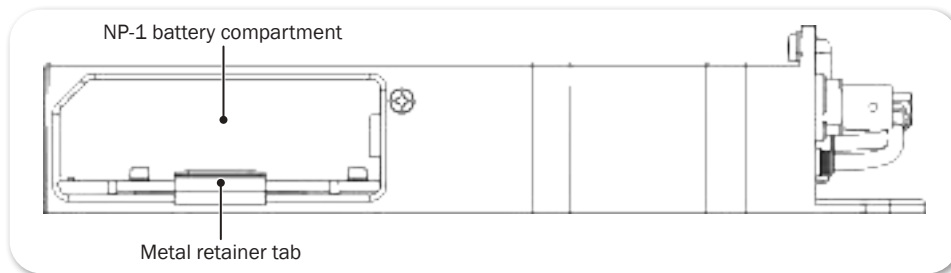

SL-6 RIGHT PANEL

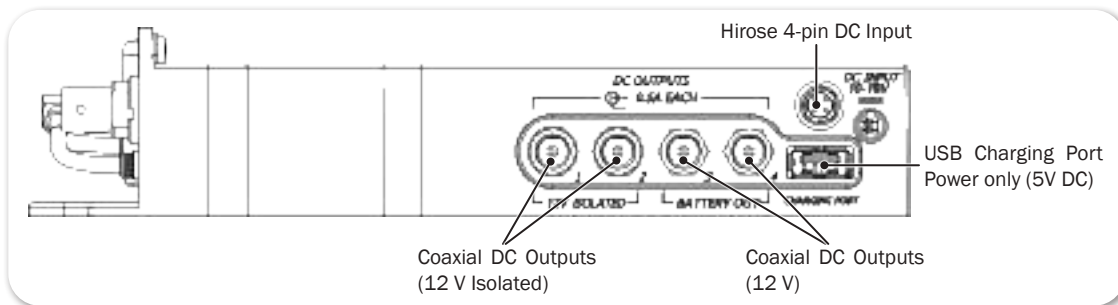

Feature	Description
Hirose 4-pin DC Input	Hirose 4-pin DC input for powering the SL-6 and Scorpio. Power must be attached to this connector or an NP-1 battery must be inserted to power the SL-6 and Scorpio.
Coaxial DC Outputs (12 V Isolated)	Isolated 12 V DC outputs that draw from the active SL-6 power source (Hirose 4-pin or NP-1). Each output is on by default but can be switched off from the Power section of the Main menu.
Coaxial DC Outputs (12 V)	12 V DC outputs that draw from the active SL-6 power source (Hirose 4-pin or NP-1). Each output is on by default but can be switched off from the Power section of the Main menu.
USB Charging Port	Standard USB 5 V DC output that draws from the active SL-6 power source (Hirose 4-pin or NP-1). The USB port on the SL-6 is designed for charging only, not for data transfer.

POWERING WITH THE SL-6

The SL-6 features two power inputs: NP-1 battery and external DC. The SL-6, its attached receivers, the Scorpio, and any devices powered from the SL-6 DC outputs require one of these power sources to operate. When both SL-6 power sources are depleted or disconnected, the SL-6 PowerSafe™ battery will keep the SL-6 and attached devices powered for 10 seconds while recording is stopped as long as an L-mount or DC power source is connected to Scorpio.

Power sources connected directly to the Scorpio (external DC or the L-mount batteries) will not power the SL-6 or any peripheral devices attached to the SL-6.

Remove DC1 and DC2 powering from the Scorpio while using the SL-6. L-Mount batteries can be left inserted in Scorpio while the SL-6 is being used.

When an SL-6 is attached, the following settings are available in the Power menu.

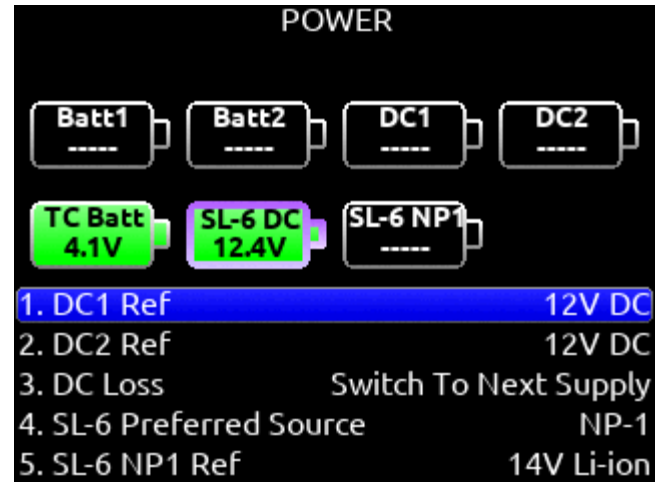

SL-6 PREFERRED SOURCE Selects whether the NP-1 or DC input takes priority.

SL-6 DC REF Allows proper power level based on the type of DC power source used [12 V DC, 14 V Li-ion, 12 V Lead Acid, Full Range]

SL-6 POWER OUTPUTS Selects whether SL-6 power outputs 1-4 and USB charging port are on or off.

When using an external BDS switch to power the entire Scorpio/SL-6 system, set DC Loss to 'Turn Off' and ensure no NP-1 battery is connected to the SL-6 and no DC power is connected to the DC-1 or DC-2 jacks on the Scorpio. Leaving these power sources connected will cause the Scorpio to auto-reboot after powering down the BDS. L-Mount batteries can be left inserted in Scorpio and will not cause a reboot after powering down from an external BDS.

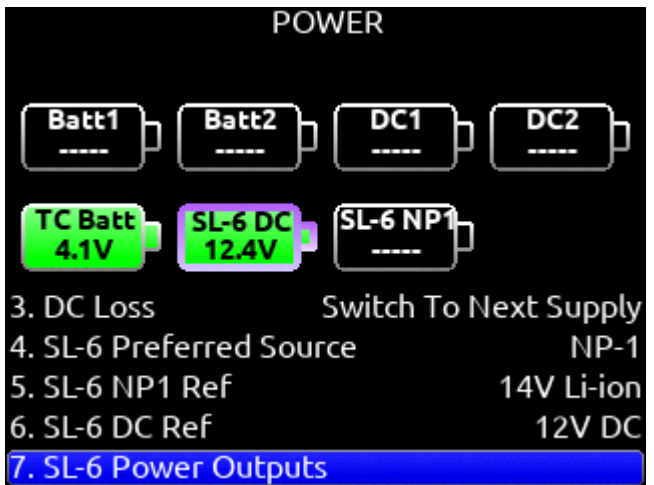

ROUTING SL-6 SOURCES TO CHANNELS

The SL-6 has a total of six channels of wireless from the three slots. To route an SL-6 Source to a channel, access a channel's source screen and select from A1, A2, B1, B2, C1, or C2. When an SL-6 channel is selected as the source, use the */** toggle as a shortcut to the selected receiver's setup screen.

For SL-6 A1-A2, B1-B2, C1-C2, channel trim gain range is -20 to 50 dB. When the A10-RX is receiving signal from the A20-Mini, the trim gain of the associated 8-Series channel is 0 to 60 dB. See GainForward.

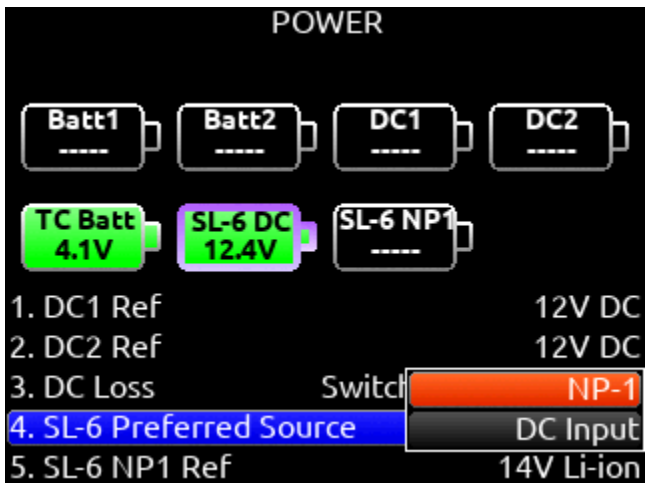

SL-6 RECEIVER OVERVIEW Select the SuperSlot menu to enter the SL-6 Receiver Overview screen which displays information for all receivers connected to the SL-6.

Hold Meter then press the HP knob to quickly access the Receiver Overview screen.

A1, A2, B1, B2, C1, C2 Use the Select knob to scroll and select an SL-6 channel to access the individual Receiver Setup screen. See Receiver Setup Screen for more details.

POST-TRIM CHANNEL METERING Displays the post-trim audio level of the Scorpio channel receiving audio from the SL-6 source. *When the SL-6 source is not routed to a Scorpio channel, no signal is displayed on the meters.*

RF FREQUENCY Displays the frequency of the receiver in MHz.

TRANSMITTER BATTERY LEVEL: Displays the battery level of the paired transmitter, if applicable.

- Green = over 50%
- Yellow = over 20%
- Orange = over 10%
- Red = less than 10%.

TRANSMITTER RECORD STATUS Indicates the record status of the paired transmitter, if applicable.

Red = recording

RF SCAN Instigates an RF Scan of the environment using all slot receivers. Use the */** toggle switch to start the scan.

OPTIONS Access the SL-6 Options menu by using the Rtn/Fav toggle switch.

SL-6 Options

Provides access to various SL-6 settings including:

RECEIVER SLOT POWER Each slot can be individually turned On/Off to save power when not in use. *Powering receivers on and off from the receiver's user interface is not supported.*

ANTENNA A AND B POWER (BIAS) Provide 12V DC bias power for active or smart antennas.

ANTENNA FILTER Select the SL-6's front end filter to reduce the likelihood of out-of-band RF noise affecting range. Select from Wideband, 470-700 MHz, 470-590 MHz, 580-700 MHz.

RF HISTORY DURATION Sets the duration of the RF HISTORY plot. Select from 30 to 600 seconds in 10 second steps, default duration is 30 seconds.

USE WIRELESS NAMES When On the name associated with the receiver channel is automatically applied to the isolated track receiving the signal. This feature is supported by the Audio Ltd. A10-RX and the Shure ADX5D.

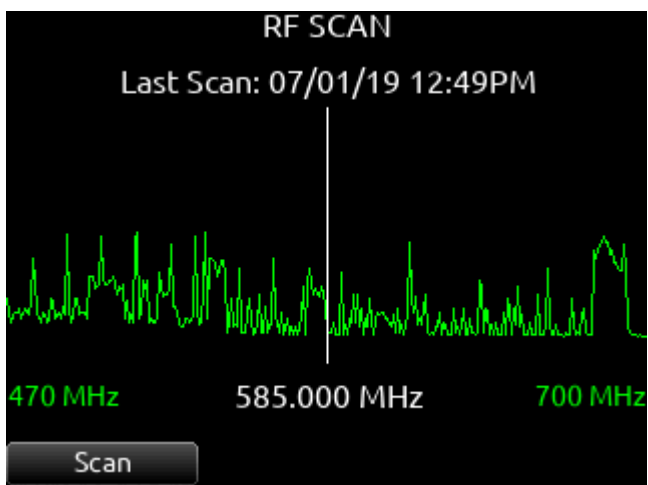
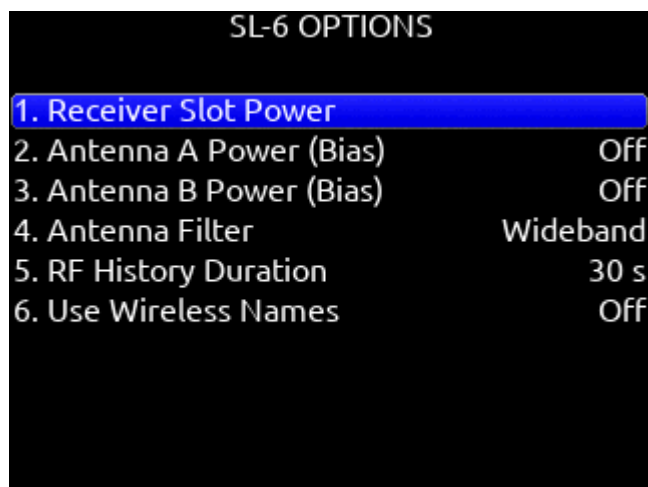

Receiver Setup Screens

When the SL-2 or SL-6 is attached, you can access Receiver Setup screens for any of the supported SuperSlot receivers available. Receiver Setup screens provide access to individual receiver RF scanning, menus for receiver setup, RF frequency adjustment, RF and audio level monitoring, transmitter recording status, transmitter Limiter/Overload/Mute status (A10-RX only), and more. The transmitter status and menu settings available depend on the receiver. Access the Receiver Setup screen from within the Receiver Overview screen by selecting the receiver channel (A1-A4, B1-B4 on the SL-2 or A1, A2, B1, B2, C1, C2 on the SL-6) using the Select knob.

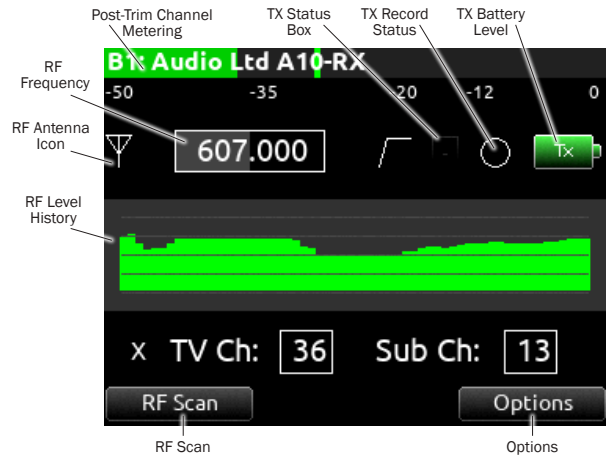

POST-TRIM CHANNEL METERING Displays the post-trim audio level of the Scorpio channel receiving audio from the SL-6 or SL-2 source. *When the SL-6 or SL-2 source is not routed to a Scorpio channel, no signal is displayed on the meters.*

RF FREQUENCY Set Receiver channel frequency in MHz or by TV channel and Sub channel.

TX BATTERY LEVEL: Displays the battery level of the paired TX, if applicable.
 Green = over 50%
 Yellow = over 20%
 Orange = over 10%
 Red = less than 10%.

TX RECORD STATUS Indicates the record status of the paired transmitter, if supported.
 Red = recording

TX STATUS BOX (A10-RX only)
 A10-TX: Indicates paired transmitter mute, Limiter, and Audio Overload status.
 A20-Mini: Indicates paired transmitter mute status. The limiter and audio load indicator are displayed for the 8-Series channel receiving the A20-Mini signal.
 Blue with 'M' = TX Mute On
 Yellow with 'L' = Limiting
 Red with 'O' = Audio Overload

RF LEVEL HISTORY Displays the RF level over a period of time. Duration of RF History is set in SuperSlot>SL-2/SL-6 Options>RF History Duration parameter from 30 to 600 seconds in 10 s steps, default duration is 30 s. The taller the green bar, the healthier the received RF signal. A red bar signifies receiver RF overload (A10-RX only).

RX ANTENNA ICON Indicates RF signal status.
 Solid white = locked to antenna signal
 Flashing white = antenna signal unlocked
 Solid Red = antenna signal overload
 Gray = no receiver detected
 (Not applicable to the Lectrosonics SRb/SRc which uses 'P' to indicate pilot tone lock status.)

RF SCAN Instigates an RF Scan of the environment using an individual SuperSlot receiver. Use the Mic/Tone toggle switch to start the scan.

OPTIONS Provides access to additional settings of the selected receiver. Options vary depending on the manufacturer and model of the receiver selected. Please refer to the user guide provided by the manufacturer of the receiver for more details.

AUDIO LTD A10-RX

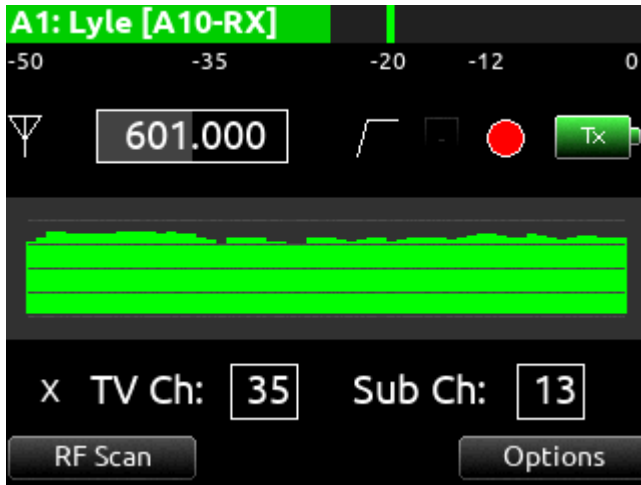

GAINFORWARD (A20-MINI)

The A20-Mini transmitter introduces GainForward, a new feature that eliminates the need to adjust microphone preamplifier gain at the wireless transmitter. Audio levels from the transmitter are controlled directly at the mixer’s trim control. If the talent speaks too softly or emotes too loudly after being “wired” with the transmitter, simply adjust the transmitter gain with the mixer’s gain trim. Read more about GainForward at:

<https://www.sounddevices.com/gainforward-explained/>

ADJUSTING AUDIO OF THE A20-MINI SIGNAL FROM SCORPIO

When the A10-RX receiving A20-Mini signal is slotted into the SL-2 or SL-6, the A10-RX Input menu settings are bypassed and all gain, low cut, and limiter activity are performed and controlled by Scorpio. See the A20-Mini and A10-RX User Guides for more information.

When Scorpio is receiving A20-Mini signal via SuperSlot the Scorpios’ trim gain is adjustable from 0 to 60 dB. The A10-RX Receiver screens display the associated Scorpio channel’s low cut, audio overload, and limiter activity.

A10-TX does not support GainForward.

USE TRANSMITTER NAMES FOR TRACK NAMES

A10-TX and A20-Mini transmitter names can be set to automatically be applied as the Scorpio’s isolated track name for the channel receiving the signal. Set Use Transmitter Names to On in the SL-2 or SL-6 Options menu.

THIRD-PARTY SUPPORTED SUPERSLOT RECEIVERS

The following pages show the Receiver Setup screens and the options menus for third-party supported SuperSlot receivers. Refer to the manufacturer for full details on features and functionality of these receivers.

LECTROSONICS SRB

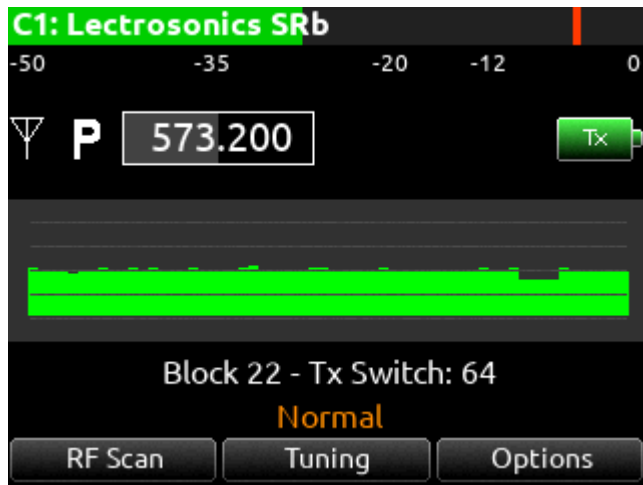

B1: Lectrosonics SRb

1. Compatibility	Hybrid
2. Diversity Mode	Switch
3. Smart Noise Reduction	Normal
4. Pilot Tone Bypass	Off
5. Tx Battery Type	AA (Timer)
6. Calibration Tone	Off
7. Show Receiver Info	

LECTROSONICS SRC

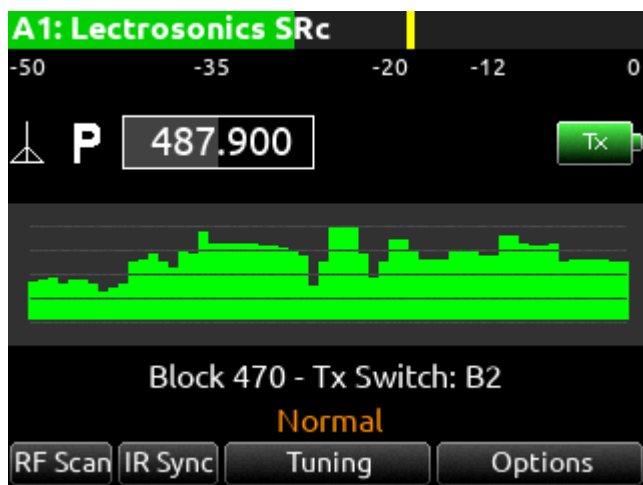

A1: Lectrosonics SRC

1. Compatibility	NA Hybrid
2. Diversity Mode	Switch
3. Smart Noise Reduction	Normal
4. Pilot Tone Bypass	Off
5. Tx Battery Type	LB-50 (Timer)
6. Calibration Tone	Off
7. Tuning Step Size	25kHz
8. Block 606 Legacy Mode	Off
9. Show Receiver Info	

SENNHEISER EK6042

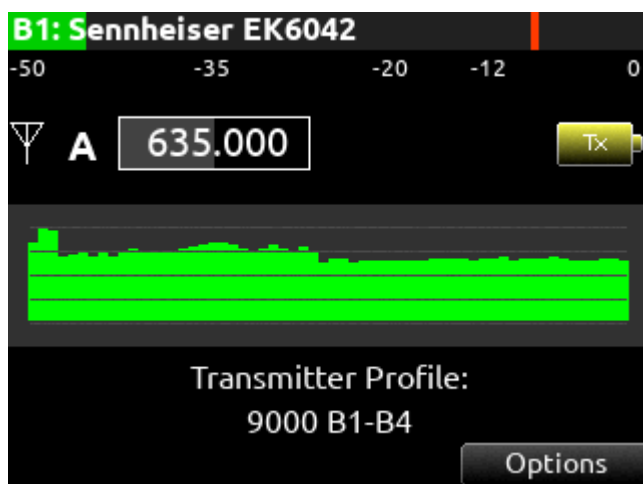

B2: Sennheiser EK6042

1. Calibration Tone	Off
2. Squelch Level	19 dBµV
3. Pilot Squelch	Active
4. Show Receiver Info	

SHURE ADX5D

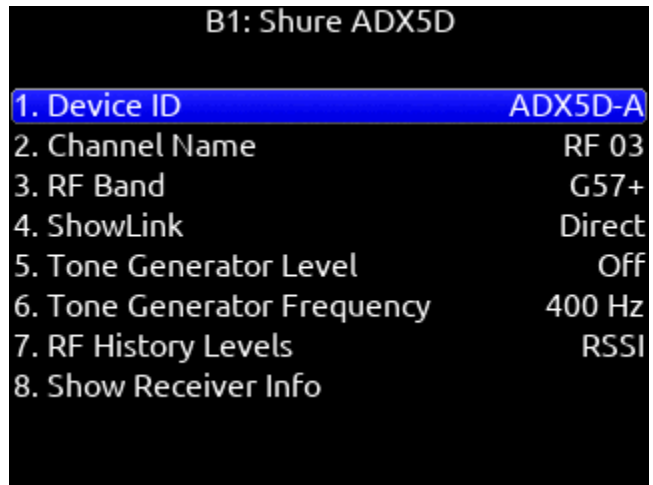
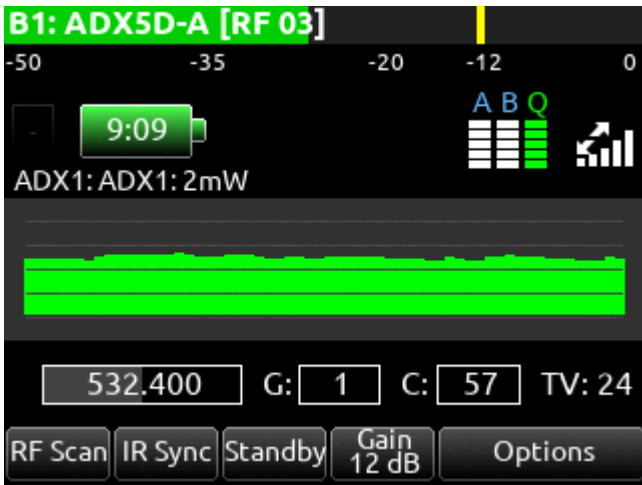

The SL-2 or SL-6 Receiver Slot Power or the 8-Series power must be cycled after performing any action from the Shure ADX5D user interface requiring the receiver to reboot. This includes powering the Shure ADX5D on and off, changing Transmission Mode, changing 3rd Party Control, or performing a Factory Reset.

SuperSlot Control of the Shure ADX5D is only available when Device Cfg >> Advanced >> 3rd Party Control is On.

When the Shure ADX5D is in High Density Transmission mode, Groups and Channels must be set from the ADX5D interface.

SONY DWR-S03D

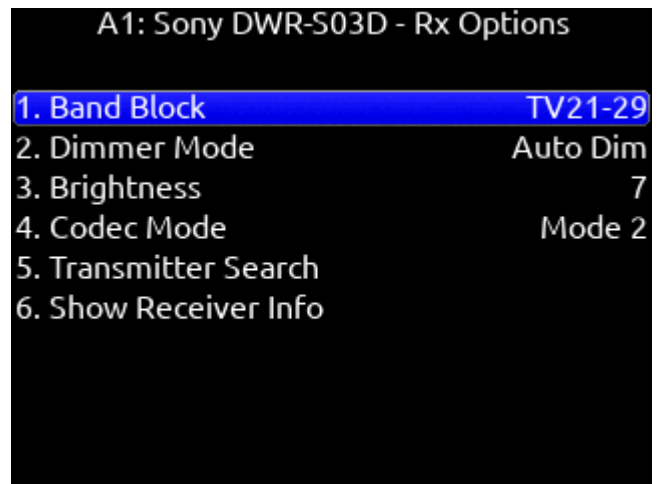
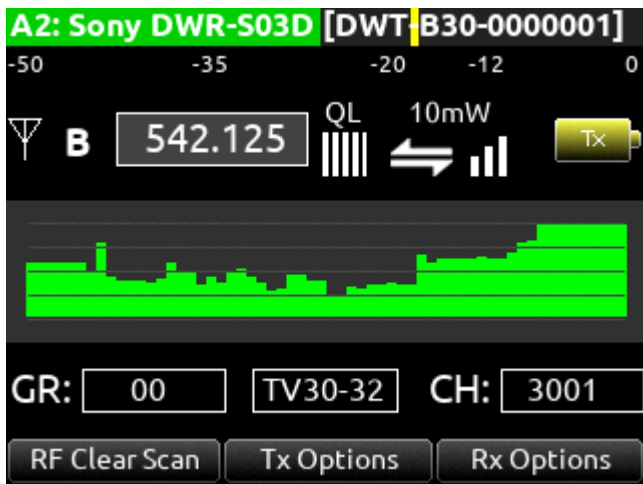

WISYCOM MCR42

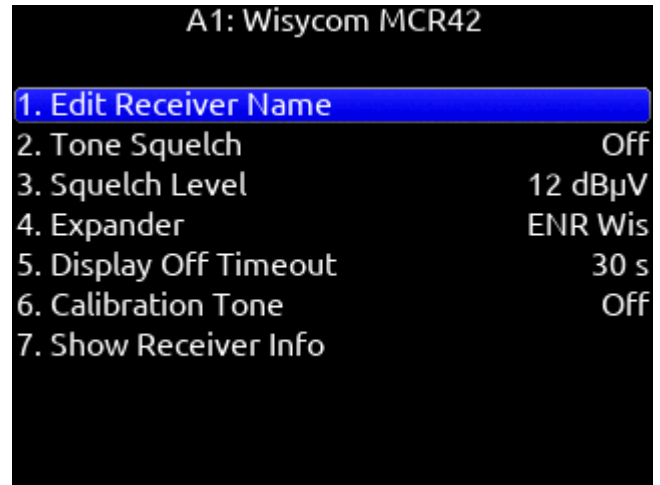

WISYCOM MCR54

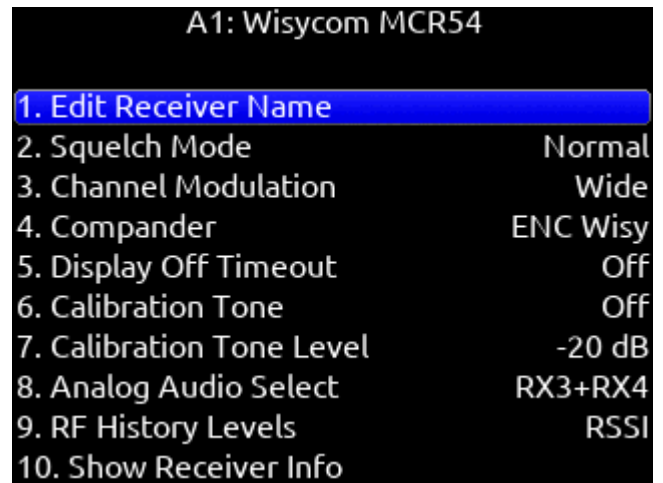

System

tone SETUP Selects the level, frequency, and routing of the internal tone generator.

- a. Level- Selects the level of the tone generator from -20 - 0 dBFS in 1 dB increments. [-20 - 0 dBFS]
- b. Frequency- Selects the frequency of the tone from 100 to 10 kHz in 10 Hz steps. [100-10 kHz]
- c. Track- [1-32]
- d. Output- [L,R, X1-X8]
- e. Bus- [L,R, 1-10] (Use toggle Switch Action menu to select tone as Continuous or L-ident.)

NOTIFICATION BELLS Selects settings for the notification bells.

- a. To HP- Routes notification bell tones to the headphones. [HP-L, HP-R]
- b. To Bus- Routes notification bell tones to the buses. [L,R, 1-10]
- c. When...- Selects when the notification bell tones are used. [Rec/ Stop, Space Low, Power Low, Warning Popup]
- d. Level- Selects the level at which the notification bell tones will be played in 1 dB increments. [Muted, -60 to -12dBFS]

FADER CALIBRATION Selects the option to manually calibrate all faders.

TIMECODE CALIBRATION Tunes Scorpio's system clock to an external LTC signal.

BRIGHTNESS Selects the brightness of the LED display and front panel LEDs.

- a. LED Brightness- Selects the front panel LED brightness in 1% steps. [1%-100%]
- b. Selects the front panel LCD display brightness in 10% steps. [10%-100%]

TIME/DATE Selects the current date and time.

- a. Time Format- [12*, 24 hr]
- b. Date Format- [mm/dd/yy*, dd/mm/yy, yy/mm/dd]
- c. Set Time/Date- Selects the current date and time.
- d. Time Zone- [-12 to +13 hours GMT]
- e. Daylight Saving- [On, Off*]

TOGGLE SWITCH ACTION Chooses what function is assigned to the toggle switches.

MENU + PFL SWITCH ACTION Chooses what menu is assigned to a Menu + PFL Switch action.

HEADPHONE ENCODER MODE Selects default operation of the HP encoder. [Vol/Preset*, Preset/Vol]

BLUETOOTH Enables or disables Bluetooth LE [On, Off]. Set to On to connect to iPad or Android SD-Remote application. Setup a password to protect against unauthorized remote control.

EXPANSION PORT Enables powering of accessories via the top panel multi-pin port [On, Off]. Accessories include the XL-AES and SL-2.

VERSION INFO Indicates current firmware version.

REGULATORY Displays relevant compliance information.

FIRMWARE UPDATE Selects any *PRG update files present on any media.

PLUGINS Shows plugins installed on the 8-Series mixer-recorder. Activates plugins on the SSD or SD card stored as LIC files. Plugins can be purchased at store.sounddevices.com

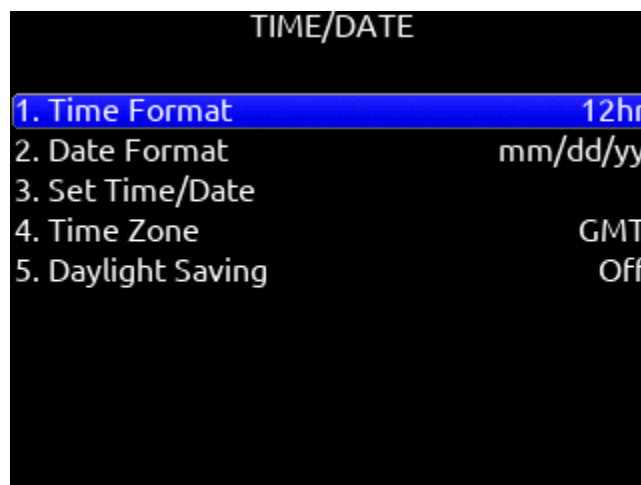
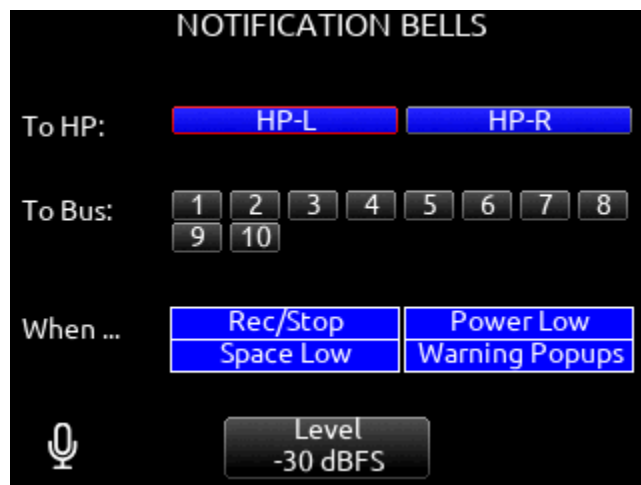
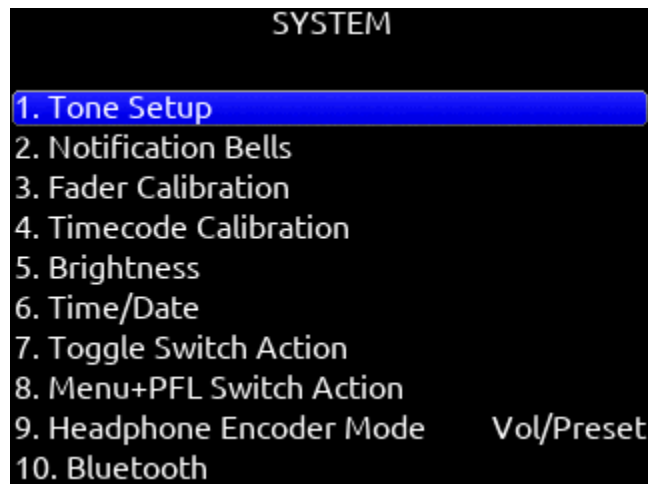

Plugins

Plugins can be purchased and downloaded from store.sounddevices.com.

AVAILABLE PLUGINS FOR SCORPIO

The following Plugins are available for the Scorpio:

- ▶ **NOISEASSIST**
 Suppress background noise instantly on-location with the optional NoiseAssist plugin for 8-Series mixer-recorders. Choose between 2, 4, and 8 instances that can be applied to any channel or bus!

- ▶ **CEDAR SDNX**
 CEDAR sdnx brings CEDAR Audio Ltd.'s highly-regarded noise suppression technology to 8-Series mixer-recorders. Choose between 2, 4, and 8 instances that can be applied to any channel or bus!

TO INSTALL A PLUGIN

Ensure the firmware version is compatible with the plugin.

1. Download the plugin file from the plugin store.
2. Unzip the folder and locate the license (LIC) file.
3. Place the LIC file on the root of an SD card formatted by the 8-Series or place on the SSD while in file transfer mode.
4. Insert the SD card into the 8-Series.
5. Navigate to Menu>System>Plugins.
6. Enter the Plugins menu and select "Apply Plugins".
 The plugin will install and the 8-Series mixer-recorder will restart.

SHOW PLUGINS Allows you to see which Plugins have been installed on the device.

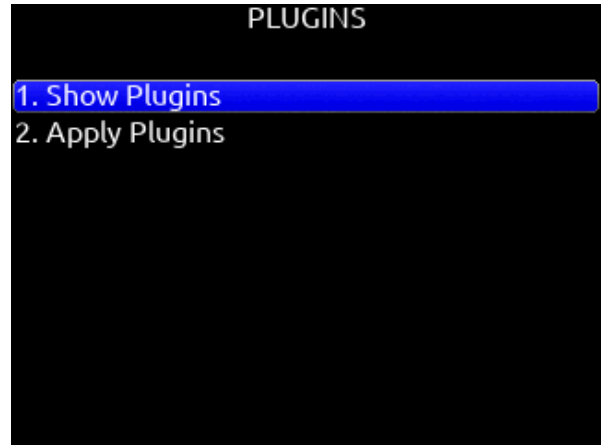

Noise Suppression Plugins

Suppress background noise instantly on-location with the optional CEDAR sdnx or Sound Devices NoiseAssist plugins for 8-Series mixer-recorders.

CEDAR SDNX

Over the last few decades, CEDAR has become synonymous with real-time, low-latency, and artifact-free audio restoration and noise suppression. CEDAR Audio Ltd.'s sdnx brings CEDAR's highly-regarded noise suppression technology to 8-Series mixer-recorders. This optional plugin reduces unwanted background noises so you can better capture dialog.

CEDAR sdnx has near-zero latency and one simple control for adjusting the amount of suppression. Up to 8 instances of CEDAR sdnx are available per mixer-recorder/device. These instances can run on any combination of isolated channels (excluding 17-32 on Scorpio) or bus. The plugin functions at sample rates up to and including 96 kHz.

Previously, using CEDAR with an 8-Series mixer-recorder required a separate hardware unit like the CEDAR DNS 2. This collaboration between CEDAR and Sound Devices marks the first time CEDAR technology has been available in-unit for any portable mixer-recorder. Now, even ultra-light portable recording setups have access to CEDAR noise suppression.

CEDAR sdnx requires 8-Series firmware v7.40 or higher. Want to try before you buy? The 2-instance version of the plugin is available as a demo on 8-Series running v7.40 or higher.

SOUND DEVICES NOISEASSIST

NoiseAssist is an advanced signal processing algorithm that reduces background noises such as traffic, generators, HVAC noise, and more. The plugins continuously monitor background noise to give you clean audio for the entire take.

Using NoiseAssist is easy and fast - simply adjust the amount of background noise to suppress and NoiseAssist will do the rest. Suppression happens in real time with just 1 ms of latency - no "learning" required. Depending on the plugin purchased, two-, four-, or eight-instances of NoiseAssist can run on any combination of isolated channels (excluding 17-32) and/or any bus.

This algorithm is optimized specifically for high-end professional film and television dialog. It accurately distinguishes the desired speech signal from background noise using proprietary advanced multi-band frequency, level, and statistical calculations. NoiseAssist maintains the excellent frequency bandwidth of the audio channel, while effectively suppressing the background noise and reverberation. NoiseAssist Plugins are available for purchase at store.sounddevices.com

Try the two-instance version of NoiseAssist Plugin in demo mode (tone bursts replace audio every 10 seconds) until the NoiseAssist Plugin license is purchased and installed. The NoiseAssist demo mode is disabled when the 8-series is powered down.

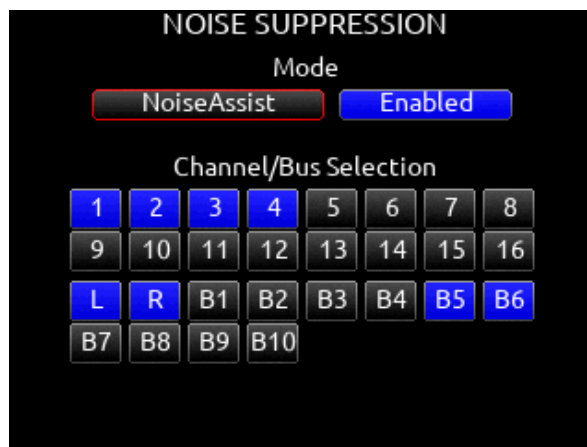
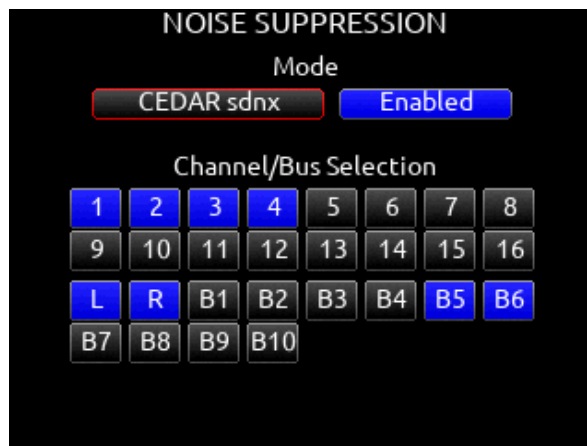

MODE Selects NoiseAssist or CEDAR sdnx and whether Noise Suppression is disabled* or enabled. The Noise Suppression field in the channel and bus screens shows as NA when NoiseAssist is active and NX when CEDAR sdnx is active.

Note: Set a toggle shortcut or mapped controller button to enable/disable Noise Suppression to allow you to quickly compare the effect of it being on or off.

CHANNEL/BUS SELECTION Selects up to eight (depending on plugin installed) instances of Noise Suppression and which channels 1-16 and/or Buses it is applied to. If the maximum number of instances are already selected, deselect one instance before selecting another.

Note: Noise Suppression only affects the mix of ISOs and return bus sources when applied to buses receiving audio from L, R, B1, B2 buses.

Note: NoiseAssist and CEDAR sdnx cannot be used at the same time. NoiseAssist is only available at sample rates of 48.048 kHz and less. CEDAR sdnx is only available at sample rates of 96 kHz and less.

ADJUSTING NOISE SUPPRESSION

In the Noise Suppression menu, ensure Noise Suppression is enabled and the required channel and/or bus is selected.

For a Channel (1-16): Enter the channel screen using the PFL toggle. Use the Select knob to scroll to and enter the NoiseAssist (NA) or CEDAR sdnx (NX) field. Rotate the Select knob to set the amount of Noise Suppression applied to the channel.

For Bus L,R: Go to Menu>Buses and select Bus L or Bus R, whichever has been enabled for Noise Suppression. Push the */** toggle to the right to select the NA or NX parameter and rotate the Select knob to set the amount of Noise Suppression applied to the bus.

For a Bus B1-10: Go to Menu>Buses and select Bus 1-10, whichever has been enabled for Noise Suppression. Push Tone toggle to display more options then push the */** toggle to the right to select the NA or NX parameter and rotate the Select knob to set the amount of Noise Suppression applied to the bus.

Noise Suppression values range from 0 dB to -20 dB with 0 dB representing no noise attenuation and -20 dB being the maximum amount of noise attenuation.

Channels or Buses enabled for Noise Suppression show a diamond in their meters. The diamond moves based on the amount of Noise Suppression averaged across all the frequency bands that have signal in them. The lower the diamond on the meter scale, the more the background noise is being attenuated. The diamond moves towards the top of the scale as the audio signal changes (for example, when a mic picks up dialog) - this indicates that the Noise Suppression algorithm is learning and adapting to the signal in real-time.

To effectively use Noise Suppression, start with the default setting of -6 dB and dial in more or less depending on your environment. An ideal setting will reduce the background noise without coloring the sound.

Note: NoiseAssist and CEDAR sdnx are not automatically linked when channels or buses are linked.

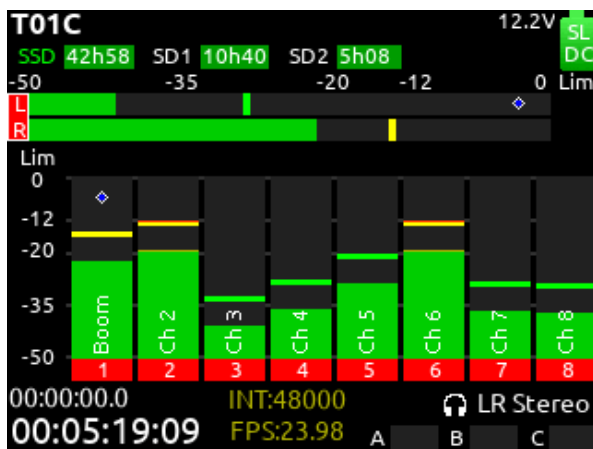
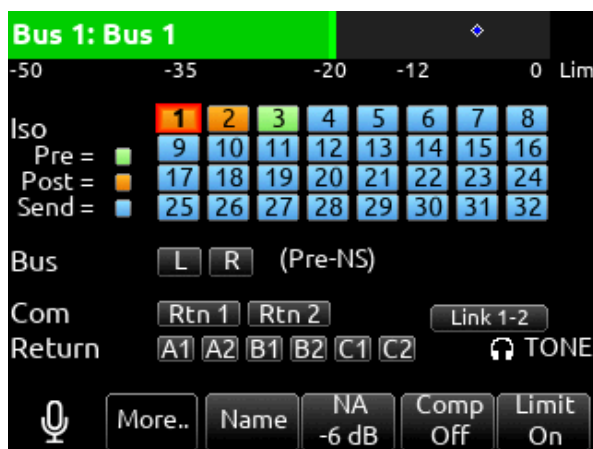
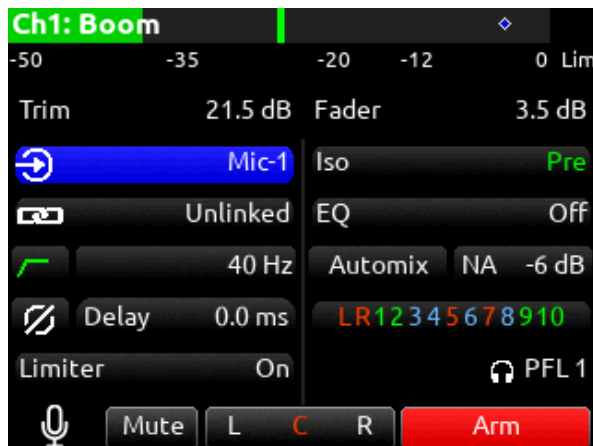

Controllers

Scorpio can be controlled from the Sound Devices CL-16 or CL-12 linear fader controllers or supported third-party external controllers that conform to the MCU protocol.

Controllers connect via the Scorpio’s USB-A port either directly or via a USB hub.

MAPPING Selects Mapping menu.

Mapping provides the ability to learn controller button presses and map them to a desired function.

- a. Name- Allows for custom naming of controller button
- b. MIDI- Toggles between the button name and MIDI code of the selected button function
- c. Load- Loads a saved button mapping preset
- d. Save- Saves a button mapping preset to any/all media. Toggle “Fav” after media selection to save.
- e. Learn- Selects learn function. To use, toggle Learn and press the desired button to be learned on the controller. Once the button has been learned, press the HP knob to scroll through the possible list of available functions (shown below) that can be assigned and select the desired function.
- f. Reset- Deletes the currently selected button mapping in the Mapping menu.

REQUIRE SHIFT FOR ARM When selected, “Shift” on external control surface must be pressed simultaneously with “Rec” to arm tracks. [Off*, On]

Applies to supported 3rd party controllers only.

REQUIRE SHIFT FOR MUTE When selected, “Shift” on external control surface must be pressed simultaneously with “Mute” to mute channels, buses, and outputs.

Applies to supported 3rd party controllers only.

DISPLAY CH. FADER GAINS Selects whether the fader gains are displayed in the controller’s display. [Off, On*]

Applies to CL-16 and 3rd party controllers.

SOLO FOLLOWS SELECT Selects whether solo (PFL) mode is engaged on a channel when pressing “Select” from the controller [Off, On*]

Applies to supported 3rd party controllers only.

DISPLAY CH. FADER GAINS Selects whether the fader gains are displayed in the controller’s display. [Off, On*]

Solo Follows Select- Selects whether solo (PFL) mode is engaged on a channel when pressing “Select” from the controller [Off, On*]

Applies to CL-16 and 3rd party controllers.

SOFT FADER/TRIM PICKUP [Off*, On] When enabled, physical faders and trims on the 8-series front panel, CL-16, CL-12, and 3rd party controllers with non-motorized faders resume gain control only when their physical position reaches the last stored gain value. This prevents sudden jumps in gain levels when setting gains from more than one control interface.

Note: Last stored gain values are held over a power cycle and may require the adjustment of a physical fader or trim control to pickup the last stored gain value.

Note: Soft Fader/Trim Pickup also works in conjunction with the SD-Remote. The 8-series trim/faders pickup control only once they have reached the last gain set in SD-Remote.

When Soft Fader/Trim Pickup is Off and a controller is connected, the 8-series front panel controls are disabled unless controlled by SD-Remote. Use SD-Remote Hide Faders function to prevent SD-Remote changing fader gains accidentally.

Note: When a non-motorized fader controller and SD-Remote are both used at the same time, the controller will not soft pickup fader or trim control.

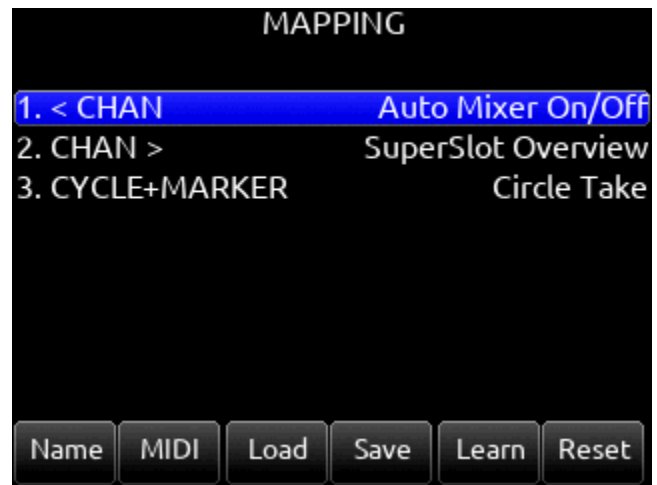
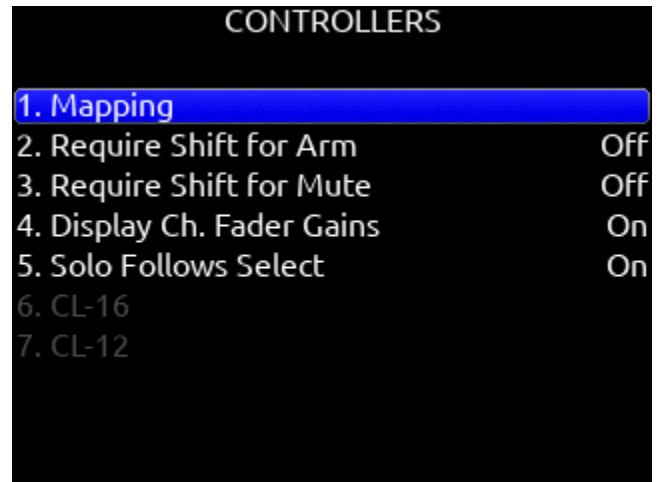

CL-16 Selects CL-16 menu.

1. LED Brightness: 5-100% in increments of 5% (100% is default)
2. LCD Brightness: 5-100% in increments of 5% (100% is default)
3. Long Button Press: 300-1000 ms in increments of 5 ms (500 ms is default)
4. Bank Disable: On or Off (off is default)
5. GPIO Configuration: Opens menu to display GPIO_1 - GPIO_8 (see below for options and details)
6. Channel Colors: Opens a menu to assign background colors to LCD channel strips 1-32.
7. Group Colors: Opens menu to assign Group 1-4 Color (Defaults: 1=Yellow, 2=Orange, 3=Light Blue, 4=Light Green). Color options: Yellow, Orange, Light Blue, Light Green, Green, Light Brown, Brown, Violet, Pink.

CL-16 Operation is covered in the [CL-16 User Guide](#).

CL-16 GPIO (GENERAL PURPOSE INPUT/OUTPUT)

The 10-pin Phoenix connector labeled Remote provides eight GPIO ports. These can be used as simple contact-closure inputs, and to drive LEDs or relays.

CL-16 REMOTE PIN FUNCTIONS

- Ground (-) - for triggering logic-low connections.
- 1 - 8 - Configurable as inputs or outputs, activate high or low, and assigned a function.
- +5 V DC - for triggering logic high connections.

Active High inputs trigger when +5V is applied.
 Active Low inputs trigger when ground is applied.
 Active High outputs go to 5 V when the mapped function is active.
 Active Low outputs go to ground when the mapped function is active.

GPIO Outputs can be used to drive LEDs with a proper series resistor. Resistor values vary from LED to LED, 470 ohms is a good starting point.

Although the CL-16 has protection against ESD (static electricity), highly inductive loads (like relays, bells etc) may require extra diode protection to protect against inductive voltage spikes. Make sure to protect the CL-16 with an anti-parallel diode across the coil of what is being driven.

CL-16 GPIO CONFIGURATION MENU

INPUT/OUTPUT toggle on Mic/Tone Switch

ACTIVE HIGH/ACTIVE LOW toggle on */** Switch

DEFAULTS GPIO_1=Record, 2=Play, 3=Stop, 4=None, 5=None, 6=Record, 7=Play, 8=Stop

AVAILABLE OPTIONS None, Auto Mixer On/Off, Bus Mode, Channel Groups Edit, Channel Sends on Faders, Channel Source Edit, Circle Take, Com Send 1, Com Send 1 (Latch), Com Send 1 (Momentary), Com Send 2, Com Send 2 (Latch), Com Send 2 (Momentary), Com Rtn 1, Com Rtn 2, Create Sound Report, Dante Out Edit, Edit Scene Name, Edit Take Notes, Edit Take Number, EQ Mode, Fader Bank Left, Fader Bank Right, False Take, Fast Fwd, Fat Ch Mode, Fat Ch Mode Bus, Fav HP Preset, Fav Toggle, Home, HP Presets Menu, Jog Is HP, Jog Is Select, Jog Wheel Press, L-Ident, LR Returns Meter, Menu, Meter, Mic Toggle, Mix Low Cut Mode, Mix Pan Mode, Mix Trim Mode, Nav Down, Nav Left, Nav Right, Nav Up, Out Mode, Play, Play Remain Time, Record, Rewind, Rtn A, Rtn B, Rtn C, Rtn Toggle, SL-6 Receiver Overview, Scene Inc, Scene Name, Select, Slate, Slate (Latch), Slate (Momentary), Stop, Take List, Take Notes Edit, Take Number Edit, Timecode Jam, Toggle Jog is Select, Tone, Tone Toggle, *Toggle, **Toggle



CL-16 GPIO WIRING DIAGRAM EXAMPLE

In this example, an external contact-closure switch starts recording and the GPIO outputs are used to sound a record bell and turn off a lighting fan.

Record bell:

GPIO pin 1 settings:-

- Output
- Active Low
- Record

Record contact-closure switch:

GPIO pin 4 settings:

- Input
- Active Low
- Record

Lighting fan control (Fan requires +5 V on its trigger input to turn off):

GPIO pin 6 settings:

- Output
- Active High
- Record

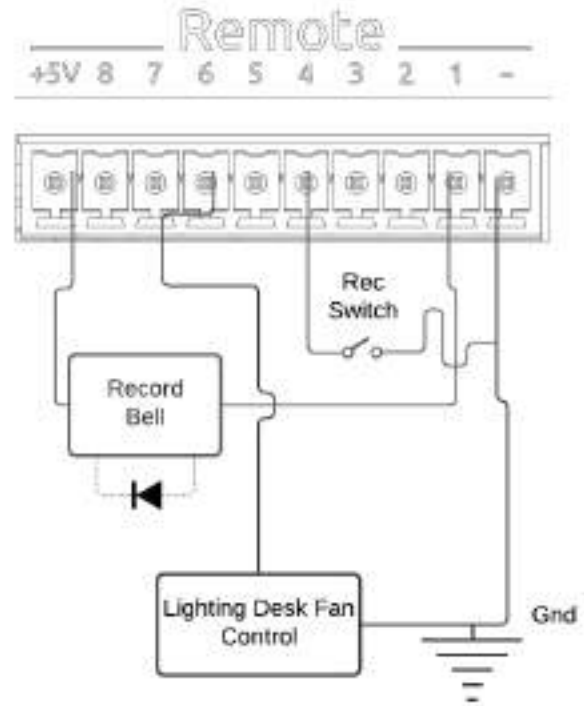

CL-12 Selects CL-12 menu.

1. L-X2 Level Controls: sets whether the L-X2 pots control bus level or output level or whether they are disabled altogether.
2. L-X2 Metering: sets whether the L-X2 meters display bus or output levels.
3. L-X2 Routing: sets whether L-X2 routing is to buses L-X2 or outputs L-X2.
4. LED Brightness: sets CL-12 LED brightness
5. SEL Follows PFL: selects whether a channel is automatically selected when its PFL is engaged.

CL-12 CONTROLLER

12 channel linear fader controller with control over fader gain, PFL, Arm, EQ, buses, outputs, coms, transport, metadata, and more. For detailed setup and operational information, please refer to the [CL-12 User Guide](#).

Tips:

When CL-12 is connected to Scorpio, trim gains are controlled from Scorpio.

Slate mic can be toggled on/off by pressing both COM 1 and COM 2 simultaneously.

When adjusting EQ from the CL-12, the EQ values are displayed at the bottom of the meter view.

A USB-A to USB-A cable is required to connect the CL-12.

Pressing stop while in stop will toggle between editing the next take and current take's scene, take and notes metadata.

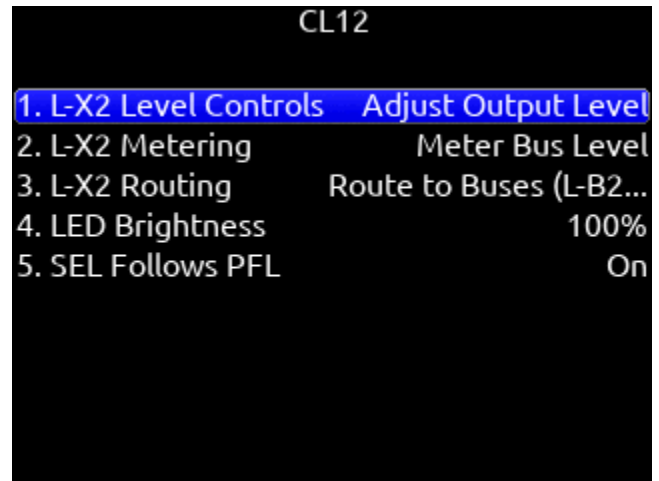

Supported Third-party Controllers

Scorpio supports some third-party external controllers that conform to the MCU protocol. Two controllers may be connected simultaneously for extended control. The CL-12 Linear Fader Controller cannot be used with another control surface.

SONOSAX SX-LC8+ Eight channel compact fader bank with faders and channel selects for channels 1-8 plus controls for slate mic, record, and stop. The Mic, Rec, and Stop buttons are mappable to other functions using the Mapping menu.*Only one LC8+ can be connected.

Ensure the Sonosax is set to USB Midi mode

1. Press and hold buttons 6 + 7 + 8 and connect the USB cable to the 8-Series USB-A port. The mode change is confirmed by a blinking REC
2. Reboot the 8-series.

ICON PLATFORM M+ AND D2 DISPLAY Eight channel fader bank with control over gain, bus, sends, coms, trim and pan. Dedicated Select, Mute, Solo and Arm buttons for each channel. Bank switch to access Scorpio channels 1-32 in four banks of eight channels.

ICON PLATFORM X+ Eight channel expansion fader bank with single assignable knob and Select, Mute, Solo and Arm buttons.

ICON PLATFORM B+ Assignable illuminated 50 pad button surface. *Connects via USB-A cable, not mini DIN.*

BEHRINGER X-TOUCH Eight channel trim and fader panel with master volume and additional mappable buttons. Bank switch to access Scorpio channels 1-32 in four banks of eight channels.

MACKIE MCU PRO Eight channel trim and fader panel with master volume and additional mappable buttons. Bank switch to access Scorpio channels 1-32 in four banks of eight channels.

All MCU controllers have custom-mappable buttons for performing any of the following actions on Scorpio:

Function	Action
Add Q-mark	Adds a Q-mark during record, playback, scrub or pause
Auto Mixer On/Off	Toggles the Auto Mixer on/off
Bus Mode	Bus Masters
Channel Groups Edit	Create/Edit channel groups
Channel Sends on Faders	Shortcut to put Bus sends on linear faders/toggle on/off
Channel Source Edit	Patch input to channel
Circle Take	Circle take
Com Send 1	Activates Com Send 1
Com Send 1 (Latch)	Activates Com Send 1 latching operation
Com Send 1 (Momentary)	Activates Com Send 1 momentary operation
Com Send 2	Activates Com Send 2
Com Send 2 (Latch)	Activates Com Send 2 latching operation
Com Send 2 (Momentary)	Activates Com Send 2 momentary operation
Com Rtn 1	Activates Com Rtn 1
Com Rtn 2	Activates Com Rtn 2
Create Sound Report	Creates Sound Report to selected media
Dante Out Edit	Shortcut to Dante Output Routing screen
Delete Q-mark	Deletes a Q-mark during record, playback, scrub or pause
Edit Scene Name	Edits the current scene name
Edit Take Notes	Edits the notes for the current take
Edit Take Number	Edits the number for the current take
EQ Mode	Spills EQ parameters over scribble strips, Fader Bank right to view last parameter. Push and hold V-Pot 1 to toggle EQ on/off, push each band's amplitude V-Pot to toggle on/off each band, push each band's Q V-Pot to toggle EQ type Shelf/Peak.
Fader Bank Left	Switches faders to left banks on connected controller
Fader Bank Right	Switches faders to right banks on connected controller
False Take	Activates False Take function
Fast Fwd	Press and hold to fast forward during playback
Fat Ch. Mode	Spills fat channel parameters across scribble strips
Fat Ch. Mode Bus	Spills fat channel bus parameters across scribble strips
Fav HP Preset	Recalls Fav HP Preset from Main Menu>Outputs>HP Presets
Fav Toggle	Emulates Fav toggle on Scorpio
Home	Activates Home screen and Trim knobs mode
HP Presets Menu	Shortcut to Main Menu>Outputs>HP Presets
Jog is HP	Switches Jog wheel to emulate HP knob on Scorpio
Jog is Select	Switches Jog wheel to emulate Select knob on Scorpio
Jog Wheel Press	Acts as "Select" while using jog wheel
L-ident	Identifies left channel output by varying amplitude vs. right channel with constant amplitude
LR Returns Meter	Activates the returns meter view
Menu	Emulates the Menu button on Scorpio
Meter	Emulates the Meter button on Scorpio
Mic Toggle	Emulates the Mic toggle on Scorpio
Mix Low Cut Mode	Activates all V-Pots to Low Cut mode on every channel. Push to reset to 0 Hz.
Mix Pan Mode	Activates all V-Pots to Pan mode on every channel. Push to center pan
Mix Trim Mode	Activates all V-Pots to Trim mode on every channel. Push to enter pan mode.
Nav Down	Moves the highlighted selection up one in matrix screens, emulates HP knob down in Home screen
Nav Left	Navigates back to previous screen
Nav Right	Selects the currently highlighted selection

Nav Up	Moves the highlighted selection down one in matrix screens, emulates HP knob up In Home screen
Noise Supp. Menu	Enters the Noise Suppression Menu
Noise Supp. On/Off	Toggles the noise suppression
Out Mode	Selects the output masters mode
Play	Plays the last recorded take
Play Remain Time	Selects the remaining time in the LED timecode display
Record	Starts record
Record Folder	Navigates to the record folder
Rewind	Rewinds during playback
Rtn A	Selects Rtn A toggle on/off
Rtn B	Selects Rtn B toggle on/off
Rtn C	Selects Rtn C toggle on/off
Rtn Toggle	Emulates the Rtn toggle on Scorpio
SuperSlot Overview	Opens the SuperSlot Overview screen
Scene Inc	Brings up the Scene Inc Dialog box for incrementing Scene Name according to the setting in Files>Scene Increment Mode
Scene Name	Brings up the Scene Name Edit virtual keyboard screen for editing the current take's scene during record and the next take's scene during stop
Select	Selects the currently highlighted selection in menus and matrix screens
Slate	Toggles Slate on/off
Slate (Latch)	Toggles Slate latching operation
Slate (Momentary)	Toggles Slate momentary operation
Stop	Stops playback
Take List	Brings up the Take List
Take Notes Edit	Brings up the Notes Edit virtual keyboard screen for editing the current take's notes during record and the next take's notes during stop
Take Number Edit	Brings up the Take Number Edit screen for editing the current take number during record and the next take number during stop
Timecode Jam	Brings up the Timecode Jam screen
Toggle Jog is Select	Toggles between Select and HP knob press on Scorpio
Tone	Toggles tone on/off
Tone Toggle	Emulates Tone toggle on Scorpio
* Toggle	Emulates * toggle on Scorpio
** Toggle	Emulates ** toggle on Scorpio

Toggle Switch Action

SELECT + MIC, HP + MIC, MIC Selects Slate, Slate (Latch), Slate (Moment), Com Send 1, Com Send 1 (Latch), Com Send 1 (Moment), Com Send 2, Com Send 2 (Latch), Com Send 2 (Moment), Ch 13 Trim/PFL (latch), Ch 14 Trim/PFL (latch), Ch 13 Fader/PFL (latch), Ch 14 Fader/PFL (latch), Add Q-mark, Delete Q-mark, Create Sound Report, Record Folder, or No Action.

SELECT + TONE, TONE Selects Continuous Tone, L-ident Tone Add Q-mark, Delete Q-mark, Create Sound Report, Record Folder, or No Action.

/* [Jam Menu, Jam A20-Menu, Circle Take, Slate, Slate (Latch), Slate (Moment), Com Send 1, Com Send 1 Latch, Com Send 1 Moment, Com Send 2, Com Send 2 Latch, Com Send 2 Moment, Rtn A, Rtn B, Rtn C, Com Rtn 1, Com Rtn 2, Automixer On/Off, Noise Suppression On/Off, Take List, Next Scene Name, Take Notes, Take Number, Current Scene Name, New Scene Name, Ch 13 Trim/PFL (latch), Ch 14 Trim/PFL (latch), Ch 13 Fader/PFL (latch), Ch 14 Fader/PFL (latch), Add Q-mark, Delete Q-mark, Create Sound Report, Record Folder, No Action]

*** + SELECT** [Ch 13 Trim/PFL (Moment), No Action]

*** + HP** [Ch 14 Trim/PFL (Moment), No Action]

**** + SELECT** [Ch 13 Fader/PFL (Moment), No Action]

**** + HP** [Ch 14 Fader/PFL (Moment), No Action]

SELECT + RTN/HP + RTN/RTN [Rtn A, Rtn B, Rtn C, Com Rtn 1, Com Rtn 2, Fav HP, Ch 13 Trim/PFL (latch), Ch 14 Trim/PFL (latch), Ch 13 Fader/PFL (latch), Ch 14 Fader/PFL (latch), Add Q-mark, Delete Q-mark, Create Sound Report, Record Folder, No Action]

SELECT + FAV, FAV + HP, FAV [Rtn A, Rtn B, Rtn C, Com Rtn 1, Com Rtn 2, Fav HP, Ch 13 Trim/PFL (latch), Ch 14 Trim/PFL (latch), Ch 13 Fader/PFL (latch), Ch 14 Fader/PFL (latch), Add Q-mark, Delete Q-mark, Create Sound Report, Record Folder, No Action]

SCENE NAME EDITING

NEXT SCENE NAME Edits the next take's scene name.

CURRENT SCENE NAME Edits the current take's scene name and applies that to the next take.

NEW SCENE NAME Creates a new scene name, adds it to the scene name entry list and in record, applies it to the currently recording take and next take. In stop, it is applied only to the next take.

Menu + PFL Switch Action

MENU+PFL SWITCH [1-12] [Power Menu, Channel Setup Menu, Channel Groupings, Channels 13-32 Menu, Buses Menu, Outputs Menu, (LR, X1-X10 Output Routing), L Out, R Out, X1 Out, X2 Out, X3 Out, X4 Out, X5 Out, X6 Out, X7 Out, X8 Out, X9 Out, X10 out, 10-Pin Out, Dante Output Routing, Dante Out 1-32, HP Presets, Limiters Menu, Meter Presets Menu, Meter Preset 1-12, Timecode/Sync Menu, Jam Timecode, Set Generator TC, Set Generator Ubits, Lemo Options, Record/Play Menu, Track To Media, Files Menu, File List, Take List, File Name Format, Sound Report Info, Slate/Coms>Returns Menu, Slate Routing, Com Send 1 Routing, Com Send 2 Routing, SL-6 Menu, System Menu, Tone Setup, Notification Bells, Brightness, Time/Date Menu, Toggle Switch Action, Menu+PFL Switch Actions, Controllers Menu, Automixer On/Off, Noise Suppression menu, Edit Scene Name, Take Number, Take Notes, Scene Name, Record Folder, SuperSlot Overview]

1. Mic	Slate
2. Select + Mic	Com Send 1
3. HP + Mic	Com Send 2
4. Tone	Continuous Tone
5. Select + Tone	L-Ident Tone
6. *	No Action
7. * + Select	No Action
8. * + HP	No Action
9. **	No Action
10. ** + Select	No Action

1. Menu+PFL 1	Power Menu
2. Menu+PFL 2	Channel Setup Menu
3. Menu+PFL 3	Channels 13-32 Menu
4. Menu+PFL 4	Buses Menu
5. Menu+PFL 5	Outputs Menu
6. Menu+PFL 6	Limiters Menu
7. Menu+PFL 7	Meter Presets Menu
8. Menu+PFL 8	Timecode/Sync Menu
9. Menu+PFL 9	Record/Play Menu
10. Menu+PFL 10	Files Menu

	Com Send 1 Routing
	Com Send 2 Routing
1. Menu+PFL 1	SL-6 Menu
2. Menu+PFL 2	System Menu
3. Menu+PFL 3	Tone Setup
4. Menu+PFL 4	Notification Bells
5. Menu+PFL 5	Brightness
6. Menu+PFL 6	Time/Date Menu
7. Menu+PFL 7	Toggle Switch Actions
8. Menu+PFL 8	Menu+PFL Switch Actions
9. Menu+PFL 9	Controllers Menu
10. Menu+PFL 10	Files Menu

Front Panel Shortcuts

The Menu + PFL Shortcuts are set by default. They can be customized by going to System > Menu + PFL Switch Action.

Menu + PFL Shortcuts	Action
Menu + PFL 1	Power Menu
Menu + PFL 2	Channel Setup Menu
Menu + PFL 3	Channels 13-32
Menu + PFL 4	Buses Menu
Menu + PFL 5	Outputs Menu
Menu + PFL 6	Limiters Menu
Menu + PFL 7	Automixer Menu
Menu + PFL 8	Meters Preset Menu
Menu + PFL 9	Timecode/Sync Menu
Menu + PFL 10	Record/Play Menu
Menu + PFL 11	Files Menu
Menu + PFL 12	Slate/Coms/Returns Menu

Toggle Switch Shortcuts	Action
Mic Toggle	As defined in the System/Toggle Switch Action menu. Default: Slate
Sel + Mic Toggle	As defined in the System/Toggle Switch Action menu. Default: Com Send 1
*/** Toggle	As defined in the System/Toggle Switch Action menu. Default: No Action
Rtn Toggle	As defined in the System/Toggle Switch Action menu. Default: Rtn A
Sel + Rtn Toggle	As defined in the System/Toggle Switch Action menu. Default: Rtn B
HP + Rtn Toggle	As defined in the System/Toggle Switch Action menu. Default: Rtn C
Fav Toggle	As defined in the System/Toggle Switch Action menu. Default: Fav HP
Sel + Fav Toggle	As defined in the System/Toggle Switch Action menu. Default: Com Rtn 1
HP + Fav Toggle	As defined in the System/Toggle Switch Action menu. Default: Com Rtn 2

Other Shortcuts	Action
Channel screen, then hold PFL for >1 sec	Edits Channel (Track) Name
Meter + Rotate HP knob	Zooms meter scale
Meter + Rotate Select knob	Adjusts LCD brightness
Meter +Select or Select +Meter	Arm or disarm Selected track.
HP + PFL 1-12	Selects HP Preset 1-12
Sel + PFL 1-12	Selects Bus 1-10, L,R
Meter + PFL 1-12	Selects Meter Preset 1-12
* Toggle + PFL 1-12	Selects Channel Screen/PFL 13-24
** Toggle + PFL 1-8	Selects Channel Screen/PFL 25-32
HP + Left on Transport Control	False Take
Sel + Fav Toggle	As defined in the System/Toggle Switch Action menu. Default: Com Rtn 1
HP + Fav Toggle	As defined in the System/Toggle Switch Action menu. Default: Com Rtn 2
Sel + Tone (hold)	L-Ident Tone
HP + Transport Control Right	Scene Increment
Sel + Transport Control Right	Add Q-mark
Sel + Transport Control Left	Delete Q-mark

USB Keyboard

A USB keyboard may be connected to the Scorpio via the USB-A port. The keyboard may be used for metadata entry as well as the following shortcuts:

Keystroke	Description
F1	Enters Main Menu
F2	Enters Take List
F3	Toggles Meter view
F5	Emulates Mic toggle
F6	Emulates Tone toggle
F7	Emulates * toggle
F8	Emulates ** toggle
F9	Emulates Rtn toggle
F10	Emulates Fav toggle
F12	Returns to LR, 1-8 Meter View
1,2,3 ... 0	Enters Channel Screens 1-10 respectively
Ctrl+1,2,3 ... 6	Enters Channel Screens 11-16 respectively
Ctrl+R	Record
Ctrl+S	Stop
Space Bar	Play/Pause
Up arrow	Emulates HP knob rotating clockwise on most screens, except channel screens where it emulates the Sel knob rotating clockwise. Channel screen and matrix screens: navigates up. HP vol in home screen, row selection in menus, parameter adjust.
Down arrow	Emulates HP knob rotating counterclockwise in most screens except channel screens where it emulates the Sel knob rotating counterclockwise Channel screen and matrix screens: navigates down HP vol in home screen, row selection in menus, parameter adjust
Enter	Home Screen: Emulates HP knob press i.e. HP Monitor Source Select List Menu screens: Emulates HP knob press i.e. Activates selection Channel screens: Emulates HP knob press Virtual Keyboard: OK
Ctrl+Up arrow	Emulates Sel knob rotating clockwise
Ctrl+Down arrow	Emulates Sel knob rotating counterclockwise
Ctrl+Enter	Emulates Sel knob press
Ctrl+P	Screenshot of current screen

X-KEYS® PROGRAMMABLE KEYPADS, STICKS & KEYBOARDS

X-keys include a variety of compact, tactile input devices that can be programmed to emulate USB keyboard commands. Their various buttons and tactile controls are programmed via P.I. Engineering's MacroWorks Windows software. When mapped as individual commands or as macro commands to Scorpio's USB Keyboard shortcuts listed above, they offer quick-access to many functions including Record, Stop, Play, and many more.

To use with Scorpio, the X-Keys device must be connected to the USB-A port. Please visit P.I. Engineering's website for more information.

SD-Remote

SD-Remote is a mobile device application designed to pair with Scorpio. SD-Remote is available for Android tablets and phones in the Google Play Store or as an APK from www.sounddevices.com, and for iPhone and iPad in the App Store. An Android tablet can be hardwired to Scorpio via USB or wirelessly connected via Bluetooth LE. An Android phone, iPhone, or iPad wirelessly connects to Scorpio via Bluetooth LE. SD-Remote offers control and display parameters, including the following:

1. Channel Meters
2. L/R Meters
3. Channel Name
4. Channel Solos/Mutes
5. Channel Record Arm/Disarm
6. Channel Trim and Fader Gains
7. Channel Pans
8. Transport Controls
9. Metadata Editing
10. Info
11. Timecode
12. Take List
13. Reports
14. File Transfer

First download and install the SD-Remote app from the Google Play Store, www.sounddevices.com, or the App Store.

SD-Remote requires the following minimum operating systems:

- ▶ iPad running iOS 12 or iPadOS 13+
- ▶ iPhone running iOS 12+
- ▶ Android tablets require Android 6 Marshmallow for USB connection. The device needs to support MIDI and BLE in order to operate.
- ▶ Android phones and tablets require Android 7 Nougat when connecting via Bluetooth LE. The device needs to support MIDI and BLE in order to operate.

Note: It is recommended to close the SD-Remote app before powering down the 8-series. This will help prevent the SD-Remote app not connecting after the next boot up. Should SD-Remote not connect to the 8-series, FULLY close then restart the app.



USB SETUP PROCEDURE FOR ANDROID TABLET

1. Connect Android tablet to the 8-Series Mixer-Recorder via USB-A port.
2. Open the SD-Remote app, access Settings [gear icon], and choose to connect via USB.
3. On the Android tablet, open the quick settings drop down menu.
4. Touch “USB Android System” twice to open “Use USB to” dialog box.
5. Touch “Connect a MIDI device.”

“No USB Connection” popup will appear when SD-Remote does not detect presence of an 8-Series Mixer-Recorder.



BLUETOOTH SETUP PROCEDURE FOR ANDROID

1. On the 8-Series Mixer-Recorder, set Bluetooth to On in the System>Bluetooth menu.
2. Open the SD-Remote app, access the settings tab, and choose “Connect via Bluetooth”.
3. Access any Metering tab and touch the Sound Devices logo button to display a list of 8-Series devices that can be connected to via Bluetooth. When the Devices Found list is shown, Bluetooth connection to the currently selected device is stopped.
4. Connect to a specific 8-Series device by touching the Bluetooth button next to its serial number. ‘Connecting...’ is displayed. Wait for connection to take place.

When connection is successful, the SD-Remote meter view is displayed.

“No Bluetooth Connection” popup will appear when SD-Remote does not detect presence of the selected 8-Series device.

For optimal Bluetooth LE connection, the Sound Devices XL-ANT2.4 Antenna must be fitted to the SMA port of the 8-Series device.



BLUETOOTH SETUP PROCEDURE FOR IPAD AND IPHONE

1. On the 8-Series Mixer-Recorder, set System>Bluetooth to On.
2. Open the SD-Remote app and touch the Sound Devices logo button to display a list of 8-Series devices within Bluetooth LE range. When the Devices Found list is displayed, Bluetooth LE disconnects from the previously connected 8-Series Mixer-Recorder.
3. Connect to a specific 8-Series device by touching the serial number. ‘Connecting...’ is displayed. When connection is successful, the SD-Remote meter view is displayed.

“No Bluetooth Connection” popup will appear when SD-Remote does not detect presence of the selected 8-Series device.

For optimal Bluetooth LE connection, the Sound Devices XL-ANT2.4 Antenna must be fitted to the SMA port of the 8-Series device.



SETTING A PASSWORD

To prevent unauthorized access to the 8-Series Mixer-Recorder via Bluetooth LE:

1. Navigate to System-Bluetooth-Set Password.
2. Create a password using the on-screen keyboard.
3. Use the Fav toggle to save the password.
4. Press “Ok” in the “Set New Password” dialog box.
5. Connect your tablet via SD-Remote to the 8-Series device as described above.
6. Enter the password and press “Enter” to allow connection.
7. Toggle “Remember Password” to allow the mobile device to connect without reentering password.

TO REMOVE A PASSWORD

1. In the 8-Series menu, navigate to System-Bluetooth-Clear Password.
2. Press “Ok” in the “Clear existing password” dialog box.

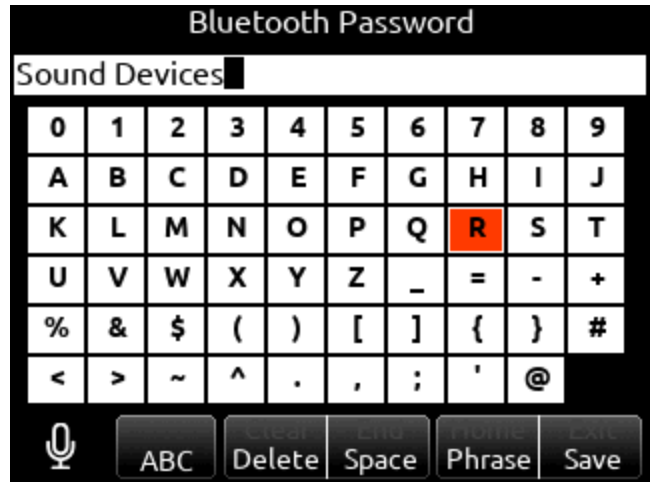

Meters View

TABLET



PHONE

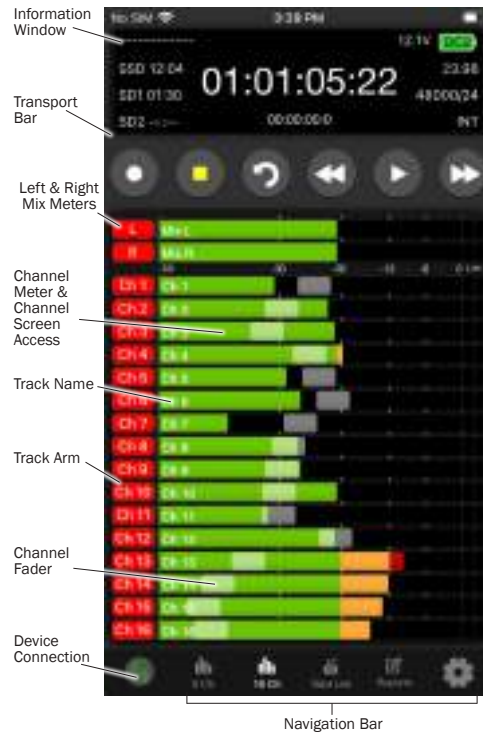

DEVICE CONNECTION Touch the Sound Devices insignia to view a list of available 8-Series Mixer-Recorders to connect via Bluetooth or USB. If already connected to a device, a 'Break Connection' popup will appear to prevent accidental disconnection.

INFORMATION WINDOW Displays current take name, power source icon with remaining voltage (remaining percentage and time with Smart Batteries), timecode, absolute time, remaining time of SSD, SD1, and SD2, Timecode frames per second, sample rate and bit depth, and sync source. Display turns red in record and green during playback.

NAVIGATION BAR Allows quick access to various meter views, Take List, Sound Reports, and Settings. Tablet views allow for quick access to all available meter screens. Phone view allows selection of 8- or 16-Channel Metering. Swipe up on the meters to view the next bank of meters.

TRANSPORT BAR Record, Stop, False Takes, Play, Rewind, and Fast Forward buttons.

CURRENT TAKE METADATA (TABLET) Displays and allows for editing of Current Take Scene, Take, and Notes. This information is also available in the Take List. Phone views do not have access to this field on Meters view.

NEXT TAKE METADATA (TABLET) Displays and allows for editing of Next Take Scene, Take, and Notes. This information is also available in the Take List. Phone views do not have access to this field on Meters view.

LEFT & RIGHT MIX METERS Displays audio activity on the Left and Right Mix Bus. Touch the track arms to arm or disarm the bus for recording.

CHANNEL NAME (TABLET) Touch to edit the channel's name. Blue fill indicates the channel is muted.

CHANNEL NAME (PHONE) Displays the channel's name. The name can be edited from the Channel Screen. Blue fill indicates the channel is muted.

CHANNEL SCREEN ACCESS (TABLET) Touch to PFL the channel and access the channel's channel screen from which Name, Trim, Fader, Pan, Mute, and PFL can be set. Yellow fill indicates the channel is PFL'd.

CHANNEL METER & CHANNEL SCREEN ACCESS (PHONE) Displays the channel's audio activity, touch the meter to access the Channel Screen. A white border around the meter indicates the channel is PFL'd.

CHANNEL FADER Touch and drag to adjust a channel's fader gain. On a tablet, the channel name cell above the meter displays the gain dB value as the fader is adjusted. To prevent accidental fader control, hide the faders by setting Hide Faders to On in the Settings tab.

TRACK ARMS Touch to arm/disarm channels. To arm/disarm multiple channels during record, touch and hold one arm button, then toggle others. A new split take will only be created once the held arm button is released.

ARM LOCK (TABLET) To prevent accidental arming or disarming, enable the Arm Lock button.



Channel Screen

From the channel screen, view a channel's audio activity, arm/disarm the isolated track for recording, edit the track name, adjust trim and fader gains, adjust pan settings, toggle mute and PFL. Tablet views allow for direct access to other channel screens via the tabs on the bottom of the screen.



Take List

From the Take List, enter metadata for Next, Current, or previous takes, select a take for playback, or view take information. The Take List View on a Tablet displays the Take List, Take Edit, and Take Info windows simultaneously. The Take List on a phone displays the Take List, selecting a take will enter the Take Edit view, selecting the 'i' icon will display the Take Info view.

In stop mode, touch a take's play icon to play back that take.

NEXT TAKE METADATA Edit scene, take, sticky notes, notes, and track names for the upcoming take.

CURRENT AND PREVIOUS TAKE METADATA Edit scene, take, notes, track names, and circle the current or previously recorded take.

TAKE INFO Displays timecode, user bits, frame rate, duration, media, roll/folder, date, time, sample rate, bit depth, channels, and whether the take is poly- or monophonic.

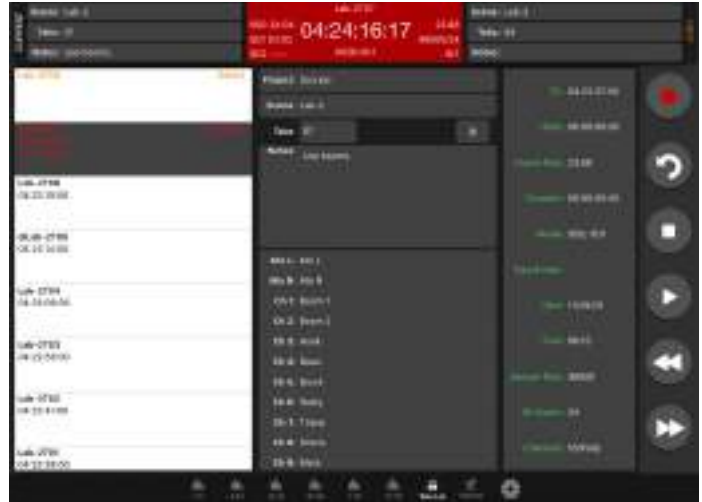

Sound Report

CREATE SOUND REPORT

1. Touch “Reports” icon on the bottom of the screen.
2. Select the source(s) from which the desired info resides. Sibling folders (folders at the same directory level) may be included in the same report by selecting “Sibling Folders.”
3. Select which Sound Report format to send. Select Email CSV and/ or Email PDF.
4. Select whether to send the CSV and PDF files individually or all as a single compressed .zip file.
5. Touch the Create Report button. Sound Reports will be shared via email while simultaneously being created on the selected source drives.

To create a report from a different day’s folder than the currently active one, go to the Scorpio’s Take List > Next Take > Rec Folder and highlight the shoot day folder you want to create the report for, then press ‘Set Folder’.
 “[current]” in orange text appears after the name of the current record folder.

To merge several folders or days into one sound report in SD-Remote, activate ‘Sibling Folders’. This will print all contents of all folders at the same directory level as the current record folder creating a sound report.



Settings

SD-REMOTE VERSION Displays the version number.

CONNECT VIA (ANDROID TABLET) Select whether to connect via USB or Bluetooth. If Bluetooth is selected, use the Connect Icon on the Meter views to connect to a device.

HIDE FADERS Turn On to hide faders in the Meter views. Faders are still available in the channel screen.

METER VIEW ARM LOCK (PHONE) Enable to prevent accidental arming/disarming in the Meter views. Track arming is still available in the channel screen.

FILE TRANSFER MODE Touch to put the 8-series into File Transfer Mode.



Quick Setup

LOAD GLOBAL SETTINGS Selects a saved settings file for loading.
[User-saved Global Settings]

SAVE GLOBAL SETTINGS Saves Global Settings to various destinations. [SSD Drive (internal), INT1-4 (internal), SD1 and SD2]

LOAD FACTORY SETTINGS Selects Factory Settings to be loaded for entire unit.

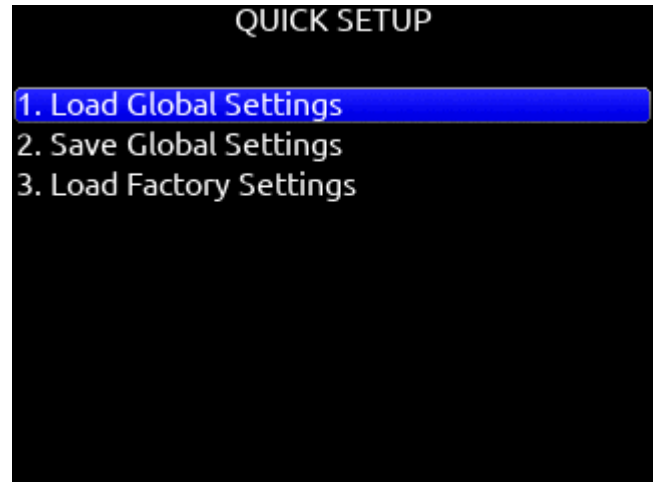

Dante



Scorpio is capable of connecting to a Dante network, simultaneously receiving and sending up to 32 channels of audio at sample rates from 44.1kHz up to 96kHz and 16 channels of audio at 192 kHz. Scorpio channels 1-32 may be sourced from Dante receive channels 1-32. Each Dante input may be selected as a source in the Channel Setup menu. Each Dante output may be sourced from ISOs (pre- or post-fade), Buses and Outputs (post-delay). All network routing should be done through Audinate's Dante Controller application, found at www.audinate.com. Once the initial configuration has been performed, the Scorpio will keep its Dante configuration through power cycles. It is recommended that, in most situations, Scorpio is selected as "Preferred Master" under the "Clock Status" tab of Dante Controller. The Primary Dante connection is the RJ45 jack closest to the center of the unit. Use the Primary connection first. A second Dante device may be connected to the Secondary (outermost) RJ45 jack.

USB-A

USB-A allows multiple devices to be used to control and monitor various functions of Scorpio. Should multiple devices be used simultaneously, the use of a USB-A type hub is required.

USB-C

USB-C allows for high-speed file transfer between a computer and any of the Scorpio's media.

All other functionality is suspended in USB File Transfer mode.

2-In 2-Out USB audio is available via the USB-C port on Scorpio. All routing is handled through the channel and output routing matrices. No special drivers are needed as the built-in OS drivers will work properly.

Windows OS users - 96kHz max sample rate, MacOS users - 192kHz max sample rate.

USB Audio is supported for Windows 10 and above.

Specifications

Specifications are subject to change without prior notice. For the latest information available on all Sound Devices products, visit our website: www.sounddevices.com.

FREQUENCY RESPONSE

10 Hz to 80 kHz \pm 0.5 dB (192 kHz sample rate, re 1 kHz)

THD + NOISE

0.005% max (mic in, 1 kHz, 22 Hz–22 kHz BW, trim at 20, fader at 0, -10 dBu in)

EQUIVALENT INPUT NOISE

-131 dBV (-129 dBu) max (mic in, A-weighting, 76 dB gain, 150 ohm source impedance)

PROCESSING ENGINE

Highly extensible, full FPGA-based audio processing, 3 FPGAs
Six-way ARM multiprocessor system
64-bit audio processing precision

AUDIO OVER ETHERNET

Dante, AES67 compatible
32 channels in, 32 channels out (up to 96 kHz); 16 channels in, 16 channels out (192 kHz)
1 Gb/s Ethernet, 2 ports, transformer-balanced

INPUTS

Mic/Line inputs: 16 total, all fully featured; 6 on full-size XLR, 2 on TA3, 8 on TA5
Mic-level inputs: (XLR, TA3, TA5): Class-A, discrete differential long-tail pair, 4k ohm input impedance
Line-level inputs: (XLR, TA3, TA5): active-balanced, 4k ohm input impedance
48V phantom: full 10mA to all 16 inputs simultaneously
22 Total analog inputs: 16 mic-line inputs, 6 on returns
AES3 or AES42 available on XLR inputs 1 and 6
AES42: +10 V, 250 mA available, mode-1, auto-ASRC
USB Audio: 2 inputs
SL-2 inputs: SuperSlot or UniSlot
SL-6 inputs: SuperSlot or UniSlot
Rtn A, B, C (3.5 mm/10-pin): unbalanced 2-channel, 4k ohm input impedance
Com Rtn 1,2 (TA3, 3.5mm) balanced, 1-channel, 8k ohm input impedance
External Slate Mic (TA5): balanced, 8k ohm input impedance, menu-selectable 12 V phantom

BUSES

12 Buses (L, R, 1-10)
Left and Right Mix Bus receives post-fade isolated channels. Optional NoiseAssist plugin instances can be applied to any bus.
Buses 1-10 can receive pre-fade, post-fade, or independent send level from isolated channels, Returns A, B, or C, and Com Returns 1 and 2.

MAXIMUM INPUT LEVEL

Mic: +8 dBu (2.0 Vrms)
Line: +28 dBu (19.5 Vrms)
Rtn A, B, C: +18 dBu (6.2 Vrms)
Com Rtn 1, 2: +24 dBu (12.3 Vrms)
External Slate Mic: +12 dBu (3.2 Vrms)

HIGH-PASS FILTERS

Adjustable 10 Hz to 320 Hz, 18 dB/oct. 1st stage analog (before preamp), 2nd stage digital.

LIMITERS

Limiters available at all channels, buses, headphones, for all sample rates
Analog first stage, all subsequent stages digital
Attack time: adjustable 1 to 200 ms
Release time: adjustable, 50 ms to 1000 ms
Threshold: adjustable, -2 dBFS to -12 dBFS
Selectable ratio: inf:1, 20:1, 18:1, 16:1, 14:1, 12:1, 10:1
Knee: soft, hard

COMPRESSORS

Compressors available at all channels (pre- or post-fade) and buses for all sample rates
Attack time: adjustable, 1 to 200 ms
Release time: adjustable, 50 ms to 1000 ms
Threshold: adjustable, 0 dBFS to -40 dBFS
Selectable ratio: adjustable, 1:1 to 20:1
Knee: soft, hard

DELAY

Channel Adjustable 0-50 ms
Output Adjustable 0-500 ms

MAXIMUM GAIN

Trim stage (mic input): 76 dB
Trim stage (line input): 50 dB
Fader stage: 16 dB
Bus stage: 16 dB
Headphone stage: 20 dB
Mic-to-Line: 108 dB
Mic-to-Headphone: 112 dB
TA5 (along with mic input pins) for single connection to headset + mic
High output, 4 ohm output impedance, 400 mW + 400 mW at each connector, all individually driven
Compatible with headphones of any impedance

OUTPUTS

XLR (L, R) active-balanced, 250/3.2k/120 ohms (mic/-10/line)
Hirose 10-pin (L, R) active-balanced, 250/3.2k/120 ohms (mic/-10/line)
TA3 (X1-X6) active-balanced, 250/3.2k/120 ohms (mic/-10/line)
3.5mm (X7, X8): unbalanced, stereo, 1.8k ohms

HEADPHONE OUTPUTS

¼", 3.5 mm
TA5 (along with mic input pins) for single connection to headset + mic
High output, 4 ohm output impedance, 400 mW + 400 mW at each connector, all individually driven
Compatible with headphones of any impedance

MAXIMUM OUTPUT LEVEL

(all into 10k load)
Line: +20 dBu (7.8 Vrms)
“-10”: +6 dBu (1.5 Vrms)
Mic: -20 dBu (0.078 Vrms)
X7/X8 Out: +6 dBu (1.5 Vrms)
Headphone outputs (¼", TA5, X9/X10): +14 dBu (4.0 Vrms)

A/D CONVERTERS

32-bit, 120 dB, A-weighted dynamic range typical
Sampling rates 44.1 kHz, 47.952 kHz, 48 kHz, 48.048 kHz, 88.2 kHz, 96 kHz, 192 kHz

DIGITAL OUTPUTS

AES3 transformer-balanced, in pairs; 1-2 (XLR-L), 3-4 (XLR-R), 5-8 (Hirose 10-pin A)
110 ohm, 2 V p-p, AES and S/PDIF compatible

RECORDING

Internal 256 GB SSD, two removable SD Cards
10% over-provisioned for optimum performance
Selectable bit depth 16 or 24-bit
Simultaneous recording to internal SSD and the two SD cards
exFAT formatting
36 tracks (32 ISO channels, 4 buses)
Broadcast WAV monophonic and polyphonic file format
64-bit WAV (RF64) monophonic and polyphonic; support for files > 4 G
AAC 2 track at 48 kHz, selectable bit rate 32, 64, 128, 192, 256 kbps

AUTOMATIC MIXING

Dugan Automixer up to 16-channels on Left and Right Mix bus
MixAssist up to 16-channels on Left and Right bus

NOISE SUPPRESSION

Via optional paid Sound Devices NoiseAssist or CEDAR sdnx Plugins
Two, four, or eight instances of Noise Suppression can run on any combination of isolated channels (excluding 17-32 on Scorpio), or buses.
Attenuation range: 0-20 dB
NoiseAssist operates with sampling rates of 44.1 kHz to 48.048 kHz.
CEDAR sdnx operates with sampling rates of 44.1 kHz to 96 kHz.
NoiseAssist audio path latency: 0.77 ms @ 48kHz
CEDAR sdnx audio path latency: 0.27 ms @ 48kHz, 0.14ms @ 96kHz

USB

USB-C (USB 3.1 type 1) for file transfer of internal SSD, both SD Cards
USB-C 2-in/2 out audio streaming
USB-A host for keyboard, external controller, external USB hubs supported for connecting multiple devices

TIMECODE AND SYNC

Modes Supported: Off, Rec Run, Free Run, 24h Run, External, including External Auto-Record and Continuous modes.
Frame Rates: 23.98*, 24, 25, 29.97 DF, 29.97 ND, 30 DF, 30 ND
Sample/Timecode Accuracy: 0.1 ppm (0.25 frames per 24 hours)
Timecode Input: 20k ohm impedance, 0.3 V - 3.0 V p-p (-17 dBu - +3 dBu)
Timecode Output: 75 ohm impedance, 5 V p-p (+7 dBu)
Word Clock Input: 10k/75 ohm selectable impedance, 1-5 V p-p input sensitivity
Word Clock Output: 75 ohm impedance, 5 V p-p output, at SR

REMOTE CONTROL

Sound Devices CL-16 Linear Fader Controller
Sound Devices CL-12 Linear Fader Controller
USB MIDI MCU Control - supported 3rd party fader controllers
SD-Remote Android Tablet app via USB or Bluetooth LE
SD-Remote Android Phone app via Bluetooth LE
SD-Remote iPad and iPhone app via Bluetooth LE
USB Keyboard
External Timecode Record Trigger

FILE DELIVERY TO CLOUD

Compatible with Frame.io Camera to Cloud
Compatible with Viviana Cloud

LCD

320x240, transfective, excellent sunlight visibility
Larger touchscreen display available via SD-Remote app

POWER

External: 10-18 V input on locking TA4 connector, pin-4 = (+), pin-1 = (-),
Dual rear-mount Sony-style L-mount batteries with chargers
Current Draw, at 12V no battery charging:
All mic preamps off: 950 mA
All mic preamps on: 1.26 A
All mic preamps on, 192 kHz sample rate, recording to internal SSD and 2 SD Cards: 1.42 A
All mic preamps on, 192 kHz sample rate, recording to internal SSD and 2 SD Cards, Dante enabled: 1.67 A
Intelligent power-down of unused mic preamps and other internal circuits
Smart Battery telemetry supported via DC Input

ENVIRONMENTAL

Operating: -20° C to 60° C, 0 to 90% relative humidity (non-condensing)
Storage: -40° C to 85° C

DIMENSIONS (H X W X D)

5.1 cm x 32 cm x 20.5 cm
2.0 in. x 12.6 in. x 8.1 in

WEIGHT

5.8 lbs (unpackaged, without batteries)
2.63 kg (unpackaged, without batteries)

FCC & ISED Compliance Statements



This device complies with part 15 of the FCC Rules. Operation is subject to the following two conditions: (1) This device may not cause harmful interference, and (2) this device must accept any interference received, including interference that may cause undesired operation.

Changes or modifications not expressly approved by the manufacturer could void the user's authority to operate the equipment.

This device contains transmitter module FCC ID: XF6-M7DB6
This device contains transmitter module IC: 8407A-M7DB6

FCC Interference Statement

This equipment has been tested and found to comply with the limits for a Class B digital device, pursuant to part 15 of the FCC Rules. These limits are designed to provide reasonable protection against harmful interference in a residential installation. This equipment generates, uses and can radiate radio frequency energy and, if not installed and used in accordance with the instructions, may cause harmful interference to radio communications. However, there is no guarantee that interference will not occur in a particular installation. If this equipment does cause harmful interference to radio or television reception, which can be determined by turning the equipment off and on, the user is encouraged to try to correct the interference by one or more of the following measures:

- Reorient or relocate the receiving antenna.
- Increase the separation between the equipment and receiver.
- Connect the equipment into an outlet on a circuit different from that to which the receiver is connected.
- Consult the dealer or an experienced radio/TV technician for help.

FCC & ISED User Statement

This device complies with FCC and ISED RF exposure limits for general population / uncontrolled environments.

Cet appareil est conforme à la norme FCC et ISED les limites d'exposition pour la population générale / l'exposition incontrôlée.

A separation distance of at least 20cm must be maintained between the antenna and all persons.
This device must not be co-located with any other antenna or transmitter.

This device (containing FCC ID: XF6-M7DB6, IC: 8407A-M7DB6) has been approved to operate with the antenna type listed below:

Model: GW.71.5153	Type: 2.4/5.8GHz Dipole Antenna
Manufacturer: Taoglas	Max. Gain: 3.8dBi (2.4GHz), 5.5dBi (5.8GHz)

No change to the antenna type is permitted. Any change to the antenna could result in the device exceeding the RF exposure requirements and void the user's authority to operate the device.

This Device complies with Industry Canada License-exempt RSS standard(s). Operation is subject to the following two conditions: 1) this device may not cause interference, and 2) this device must accept any interference, including interference that may cause undesired operation of the device.

Cet appareil est conforme avec Industrie Canada, exempts de licence standard RSS (s). Son fonctionnement est soumis aux deux conditions suivantes: 1) ce dispositif ne peut pas causer d'interférences, et 2) ce dispositif doit accepter toute interférence, y compris les interférences qui peuvent causer un mauvais fonctionnement de l'appareil.

Incorrect use of batteries poses a danger of explosion. Replace only with the same or equivalent type.
Properly recycle batteries. Do not crush, disassemble, incinerate, dispose in a fire or expose batteries to high temperatures.

Declaration of Conformity

Manufacturer's Name: Sound Devices, LLC
Manufacturer's Address: E7556 State Road 23 and 33
Reedsburg, WI 53959 USA



Declares under sole responsibility that the product as delivered

Product Name: Scorpio
Model Number: Scorpio
Description: Premium Portable Mixer-Recorder
Product Options: This declaration covers all options of the above product.

Complies with the essential requirements of the following applicable European Directives, and carries the CE marking accordingly:

Radio Equipment Directive (2014/53/EU)
Article 3.1b:
ETSI EN 301 489-17 v3.1.1
EN 55032:2012
EN 55032:2/AC:2013
CISPR 32:2012
EN 55103-2:2009
Article 3.2:
ETSI EN 300 328 v2.1.1

This Declaration of Conformity applies to the above-listed product(s) placed on the EU market after:

April 20, 2019

Date



Matt Anderson - Sound Devices, LLC President

Warranty

Sound Devices, LLC warrants the items listed above against defects in materials and workmanship for a period of ONE (1) year from date of original retail purchase. Users who register their product directly with Sound Devices Technical Support using the online form or by phone, will receive an additional ONE (1) year of warranty coverage, extending the complete warranty period to TWO (2) years from the date of original retail purchase. In order to extend the warranty coverage period, registration must be completed within the initial ONE (1) year warranty period. Products must be purchased through authorized Sound Devices resellers to qualify for Warranty coverage. Damage resulting from the opening of a Sound Devices product or attempted repairs by a non-authorized Sound Devices repair technician will void warranty coverage.

This is a non-transferable warranty that extends only to the original purchaser. Sound Devices, LLC will repair or replace the product at its discretion at no charge. Warranty claims due to severe service conditions will be addressed on an individual basis.

THE WARRANTY AND REMEDIES SET FORTH ABOVE ARE EXCLUSIVE. SOUND DEVICES, LLC DISCLAIMS ALL OTHER WARRANTIES, EXPRESS OR IMPLIED, INCLUDING WARRANTIES OF MERCHANTABILITY AND FITNESS FOR A PARTICULAR PURPOSE. SOUND DEVICES, LLC IS NOT RESPONSIBLE FOR SPECIAL, INCIDENTAL, OR CONSEQUENTIAL DAMAGES ARISING FROM ANY BREACH OF WARRANTY OR UNDER ANY OTHER LEGAL THEORY. Because some jurisdictions do not permit the exclusion or limitations set forth above, they may not apply in all cases.

For all service, including warranty repair, please contact Sound Devices for an RMA (return merchandise authorization) before sending your unit in for repair. Product returned without an RMA number may experience delays in repair. When sending a unit for repair, please do not include accessories, including SSD drives, CF cards, batteries, power supplies, carry cases, cables, or adapters unless instructed by Sound Devices. Sound Devices repairs and replacements may be completed using refurbished, returned or used parts that have been factory certified as functionally equivalent to new parts.

Sound Devices, LLC

Services Repair RMA #XXXXX

E7556 State Road 23 and 33
Reedsburg, WI 53959 USA
Telephone: +1-608-524-0625

Glossary

¼-inch jack

Common analog audio connector used as both an audio input and output. When a ¼-inch jack is described as TRS (tip-ring-sleeve) it can be wired as either a balanced connection or as a two-channel connection. ¼-inch headphone jacks are typically wired as TRS stereo jacks.

3.5 mm jack

Common small-format audio connector. Often used for headphones and -10 dBV signals for portable audio devices.

10-pin Hirose

A high-density multi-pin connector commonly used to connect an audio mixer with video cameras. Sound Devices has numerous field mixers with 10-pin Hirose connectors. Dedicated fantail breakout cables from Sound Devices and other third parties offer Hirose-to-XLR and 3.5 mm connections to simplify connection.

Advanced Audio Coding (AAC)

An audio coding standard for lossy digital audio compression. Designed to be the successor of the MP3 format, AAC generally achieves better sound quality than MP3 at the same bit rate.

AES3

A standard for the exchange of digital audio signals between professional audio devices. An AES3 signal can carry two channels of PCM audio over balanced, 110 ohm interconnections. AES3 is most commonly interconnected with XLR-3 cables.

AES42

A digital interface protocol for microphones and microphone inputs. Microphones conforming to this standard directly output digital audio through an XLR or XLD male connector, rather than producing an analog output. AES42 microphones require powering.

Attenuation

A reduction in the level of an audio signal. Attenuation can be applied to both analog and digital signals. A fader is used primarily to attenuate signals, though a small amount of positive gain is often available on a fader.

bEXT chunk

Broadcast WAV extension data added to the audio data in a WAV file. The bEXT chunk includes timecode and user bit data. For systems that do not recognize the bEXT chunk this additional information is ignored.

Bias voltage

Voltage typically applied to a lavalier microphone from a wireless transmitter or XLR adapter to power condenser capsules and/or impedance converters. Different from phantom power, bias voltage is most commonly single-ended, being sent only on one connection.

Bit depth

When converting between analog and PCM digital audio the amplitude of an analog signal is measured in finite steps, measured in bits. Higher bit rates result in greater resolution of amplitudes, resulting in higher dynamic range. 24-bit audio, with a theoretical maximum dynamic range of 144 dB, is the standard bit depth used throughout the audio chain for production.

Broadcast WAV, BWAV

Broadcast WAV files are WAV files with additional, non-audio data, such as bEXT chunk data. Broadcast WAV files offer timecode support.

Bus

An audio path that is the destination of one or multiple (mixed) channels. A bus is typically routed to an output, a record track, or both.

Camera return

An audio input on a mixer designed to receive the output, typically the headphone output, of a camera. Camera return inputs allow the user to monitor the level and quality of the signal received at the camera. In Scorpio the camera returns can be used as a source for any channel.

CEDAR sdnx™

CEDAR Audio Ltd.'s highly-regarded noise suppression technology is available as an optional paid plugin from store.sounddevices.com. Use CEDAR sdnx to reduce unwanted background noises so you can better capture dialog. CEDAR sdnx has near-zero latency and one simple control for adjusting the amount of suppression. Up to 8 instances of CEDAR sdnx are available per mixer-recorder/device. These instances can run on any combination of isolated channels (excluding 17-32 on Scorpio) or bus.

Channel

A "slot" of a mixer that is controllable and routable. A given input feeds the channel and the channel's settings process and route the audio as required. It can also be thought of as the path its selected input signal takes on its way to its record track, a bus, or an output.

Channel grouping

With Scorpio any of the first 16 channels can be grouped together so that their faders, record arming state mute states can be controlled together. Channel grouping can be used as an alternative to sending channels to a bus.

Circled take

An identifying character, the @ symbol, which is placed in the file name to highlight a take. Circled takes can either be used to identify good takes or to identify tracks or takes that will be ignored.

Compression

A tool that reduces the overall dynamic range of an audio recording by attenuating louder signals and boosting quieter signals to a more uniform range.

Com return

A dedicated audio input designed to receive signals from a PL, or private line communications circuit. The com return on Scorpio can be routed to an output or a bus.

Com send

A dedicated output designed to send signal to a PL (private line, talkback) communications circuit. The com send is toggled by a front panel switch.

Dante

A combination of software, hardware, and network protocols that deliver uncompressed, multi-channel, low-latency digital audio over a standard Ethernet network using Layer 3 IP packets.

dBFS

A measurement of the signal level of a digital signal in dB increments, dB relative to full scale signal. The maximum signal in dBFS is 0 dBFS, with signals expressed with a negative sign. dBFS signal strength is an internal measurement and does not correspond to analog signals unless the relationship between analog signal and digital signal is known.

Delay (channel)

Time delay that can be applied to an individual channel. Channel delay, typically set in milliseconds, is often used to compensate for different acoustical or electrical arrival times of signals between channels.

Dugan Automix

An automatic mixing algorithm invented by Dan Dugan which when used across multiple microphone inputs for speech, makes decisions about which inputs should be given priority due to speech being present vs. open, but unused inputs. This allows for greatly improved audio by turning down the inputs that aren't used and automatically turning up the inputs that are being used in real-time and transparently.

Ethernet

A family of computer networking technologies. Ethernet commonly refers to the physical interconnection of the network typically using twisted-pair copper connections on CAT cable with RJ-45 connectors. Common Ethernet data speeds include 10 Mbs, 100 Mbs, and 1000 Mbs.

exFAT

A storage volume format that can be read and written from current versions of MacOS and Windows. exFAT supports volume sizes up to 128 PB (gigantic), and individual files can have a maximum size of 16 EB (even more gigantic, bigger than the maximum volume size).

Fader

A physical control on a mixing console, either a rotary or sliding potentiometer, that controls the level of a channel to a bus. Most faders have more attenuation than gain available and a unity gain position where the input trim level established the level to the bus.

False take

A recorded take that was either erroneously recorded, or a take that needs to be repeated. It can be labeled after recording. An identified false take is moved to the trash bin and the auto-incrementing take number is reset to the value prior to the false take.

File list

Every file recorded by a recorder is visible in the file list. It can be viewed either on a recorder or from a computer when the recording volume is mounted. The file list shows all the individual files recorded by a recorder.

Frame rate

The rate at which video or motion picture images are recorded or played back, measured in frames-per second (FPS). All audio and video devices must be running at the same frame rate to keep audio and video synchronized. Timecode frame rates are either an integer or non-integer value. Integer values include 24, 25, and 30 FPS. Non-integer frame rates include 23.976 and 29.97, and 29.97 drop FPS.

Frequency

The period at which a wave oscillates, measured in hertz (Hz). Frequencies audible to humans range from 20 Hz for very low frequency signals to 20 kHz for very high frequency signals.

Gain

An increase (or decrease with negative gain) in the level of an audio signal. Gain can be applied in several locations, to both analog and digital signals. In a field mixer the microphone preamplifier provides a substantial amount of gain at the trim to raise the low level microphone signal to a usable signal in the mixer. Gain is also available at the fader. Gain of digital signals or line level analog signals is often limited. Unity gain is gain stage that neither adds or subtracts level from a signal.

Headphone monitor

Often a separate bus with a dedicated headphone volume control, the headphone monitor typically is normalised to the main left/right output bus of a mixer. Headphone sources can often be selected among soloed tracks or buses. In some products complex headphone monitoring of MS Stereo, LR stereo, and ambisonic sources is available.

High pass filter (audio)

Also referred to as a low-cut filter, this circuit reduces the amount of low frequency content in an audio signal. A HPF is particularly useful when recording speech since the human voice does not generate appreciable energy at low frequencies. The HPF reduces non-speech signals such as environmental noise, wind noise, and microphone handling noise, improving the intelligibility of speech and reducing low frequencies from overloading the input. The high pass filter is placed in the circuit close to the microphone preamplifier. High pass filters are often frequency selectable, ranging from 20 Hz to 200 Hz. HPF also have a slope, generally from 3 dB/octave to 18 dB/octave. Greater/steeper slopes offer more attenuation of frequencies just below the set filter frequency.

Input

The physical connection and associated signal type from external sources connected to a device. Inputs can include microphone inputs on XLR connectors, Dante inputs on audio-over-Ethernet, and USB audio inputs from a computer. Depending on the architecture of the mixing console its inputs may be hardwired to channels or channels can be selected from different inputs.

Input limiter

A limiter circuit reduces the peak signal levels of audio, generally to prevent signal overload. Analog inputs have a maximum input signal level that can be reached before overload/distortion is introduced. Setting the input gain correctly so that input signals do not reach this maximum level prevents most overload conditions. In the presence of very high, unexpected signals an input limiter changes the gain of the incoming signal and prevents it from overloading. Input limiters are sometimes compressor-type circuits with a ratio of infinity:1, meaning that any increase to the input signal into the limiter at the limiter threshold does not increase the output signal of the limiter. Several parameters may be available in a limiter, including knee, ratio, release, and threshold.

Isolated track

A recorded track of an individual microphone or sound source. "ISO" recordings allow for post-record mixing of individual sound elements.

iXML

An extensible data schema for audio and related metadata stored in broadcast WAV files. Manufacturer-specific data generated during recording is stored in iXML.

Line level

An analog audio signal used to interconnect audio equipment. Line level may be balanced or unbalanced, referenced to +4 dBu or -10 dBV, professional or consumer respectively.

Low cut filter

See high pass filter.

Microphone level

The audio signal generated by a microphone. Mic level signals are very low level, requiring a microphone preamplifier to bring them to usable, line levels. Interconnects with microphone level signals can be subject to noise and interference.

Mid-side linking (inputs)

When mid-side (MS) stereo inputs are used and the inputs are set to MS linking and MS decoder is activated for those inputs. This yields a stereo signal with one fader controlling overall input level and the other fader controlling the “width”, or amount of the side signal added. With an MS matrix at the input, the signal is sent to an output bus as left/right stereo. Mixers with MS matrices often allow for discrete mid and side signal recording. In that case the MS decoder can be activated at the headphone selection to monitor left/right stereo.

MixAssist™

An exclusive Sound Devices automatic mixing algorithm which when used across multiple microphone inputs for speech, makes decisions about which inputs should be given priority due to speech being present vs. open, but unused inputs. This allows for greatly improved audio by turning down the inputs that aren't used and automatically turning up the inputs that are being used in real-time and transparently.

Mix track

A recorded track that is a sum of multiple tracks. In production sound the mix track is often a single summed track of all production dialog elements. Mix tracks can also be sub-mixes of like microphones, such as a sub mix of just lavalier microphones or just boom microphones.

Monophonic WAV

A WAV file that is comprised of a single track of audio. When recording multi-track audio with monophonic WAV files each track is recorded to its own WAV file, with a file name indicating the track number. All associated monophonic files that are part of a multi-track recording will be identical lengths.

Mute

A mute control is a convenient on/off switch for a channel and an easy way to remove a channel from appearing in downstream buses. Mute an input or channel does not change levels or settings; when channels are muted and unmuted, their settings remain.

NoiseAssist™

An exclusive Sound Devices noise suppression algorithm which is available as an optional paid plugin from store.sounddevices.com. Use NoiseAssist to suppress background noises such as traffic, generators, HVAC noise, and more. The plugin continuously monitors background noise to give you clean audio for the entire take. Up to eight instances of NoiseAssist can run on any combination of isolated channels (excluding 17-32 on Scorpio), bus L, or bus R.

Notes (metadata)

A metadata field that is saved along with audio data in a recorded sound file, useful for sound report generation. Some workstation software recognizes the notes field and presents it when viewing the sound file.

NP-1(A) battery

A specific class of battery, originally developed by Sony. There are multiple chemistries in this class including lithium-ion and nickel-cadmium.

Output

The physical connection and associated signal type sent from a device. Outputs can be source from inputs, buses, record tracks, and other auxiliary signals.

Output auto-mute

When set, an output signal is muted when recording is stopped, restricting program audio from being sent to listeners “between takes”.

Output delay

A digital delay applied at the output. Signal delay is often set at an output to compensate for the delay introduced by digital imaging systems so that picture and sound remain in correct “lip sync”. Output delay is set in either frames or milliseconds.

Pan

When a channel is routed to a stereo-linked bus the level it appears at each bus is adjusted by a pan control. A channel with its pan control “straight up the center”, or “centered” sends signal at the same level to each bus. A channel that is panned left or right sends the signal to the left or right bus, respectively.

PFL, pre-fade listen

When an input or channel is selected for monitoring/solo with a PFL, the channel is routed to the headphone output before the channel fader so that the fader position has no effect on the headphone level. Trim/gain changes to the input will change the headphone output.

Phantom power

Condenser (capacitor) microphones require power for operation. They use power to charge the diaphragm backplate (for true condensers) and power the impedance convert located adjacent to the microphone capsule. Phantom power is the method for microphone inputs to supply DC power to the microphone through the same connection used for the audio signals from the microphone.

Phantom power provides a positive voltage, typically between 11-52 VDC, with 48 V being the most common, on both pin-2 and pin-3 with pin-1 used as ground. The DC voltage appears as a common-mode signal on the balanced connection and is rejected by the connection's differential amplifier. Phantom power has no effect on dynamic microphones.

Phase

The relationship one audio signal has in time with respect to another audio signal, defined in degrees of phase. When audio signals are generated at identical times, they are “in phase” with each other. When one audio signal is time-delayed with respect to another the signals are “out of phase”. Differing phase relationships can be introduced several ways, including when microphones are placed at varying distances from a sound source, or electrical/digital delay is introduced to one signal with respect to another.

Phrase

A pre-set text string which can be used to quickly fill out the notes field.

Pre-fader routing

The signal from a channel is routed to a bus before the fader in the signal path. The input trim, if available, controls the channel level sent to the bus. Isolated tracks are typically recorded pre-fader so that any level changes made to the faders don't affect the recorded signal.

Pre-roll

A continuous buffer that is always writing to memory offering a recording that begins prior to when the record button is activated. Pre-roll is set in seconds, and the recording begins the set number of seconds prior to the button being pressed. This is helpful in applications where an operator missed a cue to begin recording.

Polarity (audio)

The direction of the current flow of an audio signal is defined as polarity. The polarity of a signal can be reversed when a balanced audio signal connection has its pin-2 and pin-3 connections reversed. Single-ended signals can have their polarity reversed when going through an “inverting” gain stage. It is best practice to have all incoming and outgoing signals with the same polarity relationship.

Polyphonic WAV

An individual WAV file that contains multiple audio tracks. When recording multi-track audio with polyphonic WAV files all recorded tracks are contained within a single WAV file.

Post-fader routing (after fade routing, AFL)

The signal from a channel is routed to a bus after the fader in the signal path. The fader controls the level of the channel at the bus. Channels sent to a master bus, such as the left/right bus, are typically sent post-fader.

Post-roll

An extra period of time that is appended to the end of a recording when stop is pressed. If record is pressed during this period of time, recording will resume within the same file with no audio lost. This is particularly useful should a Director call 'cut' prematurely or accidentally.

Project

An option available for file organization on Sound Devices recorders. Projects are the highest level of file folder organization. The project folder can contain sub-folders of scene files or recorded files directly.

Record bell

A tone generated in headphones to alert the listener that recording has started. The bell is also produced when recording has ended with the stop button, when the recording volume is full, or when power is in a critical state.

Record Folder

The destination folder for recorded takes. The 8-series supports a three-tier folder hierarchy allowing for flexibility in organizing recordings.

Sampling rate

When converting between analog and PCM digital audio the analog signal is measured (sampled) in unique steps at a data rate specified in kHz. Higher sampling rates allow for representing higher frequency analog audio. 48 kHz is the standard sampling rate for production, worldwide. Higher sampling rates including 96 kHz and 192 kHz are used for high-precision applications where the representation of audio above 20 kHz is required. A general rule is that the maximum analog audio frequency is 1/2 the sampling rate.

Scene

On Sound Devices recorders the scene becomes part of the file name for a take. Scene names can be pre-loaded to quickly change between scenes.

Slate microphone

A microphone, built-in or external microphone, on an audio mixer used to notate takes or communicate with sound team members by the mixer's user speaking into the microphone. Slate microphones are often routable to buses or tracks.

Smart Battery

A lithium-ion rechargeable battery with integrated telemetry indicating battery condition, run time and other useful data.

Stereo linking (inputs)

When active for stereo sources such as stereo microphones, linked inputs are hard panned to the left and right bus. Controls including gain (trim), fader, high pass filter, delay, limiter, mute, and routing are controlled together.

Sticky Notes

Notes that persist to subsequent takes.

Solo

A control on a mixer to route a channel to headphones while muting all others. Solo and PFL are related controls and in many consoles are the same. Solo circuits can be exclusive—only one channel is sent to headphones at a time—or non-exclusive—any number of channels can be sent to the solo circuit and appear in headphones.

SuperSlot™

SuperSlot™ is an electro-mechanical connection protocol, developed by Sound Devices, to simplify the interconnection of wireless audio transmitters and receivers with audio mixers and cameras. SuperSlot provides, power, audio, and control signals over a single multi-pin connection. SuperSlot-compatible products will be offered by multiple manufacturers, including wireless system manufacturers, camera manufacturers, and audio mixer manufacturers.

TA-type connector (TA3, TA4, TA5, TA6)

Miniature XLR-type, locking connectors. TA3 connectors are used by Sound Devices for various inputs, outputs, and as balanced and unbalanced connections. TA4 connectors are used by Sound Devices for DC power connections to the Scorpio mixer-recorder. TA4 is also used for audio connections from lavalier microphones to some wireless transmitters. TA5 connectors are used for Mic/Line inputs and the headset on the Scorpio. TA6 connectors are presently not used by Sound Devices though they are used for audio connections by other manufacturers.

Take

A recorded take is an individual recorded file (or files when recording monophonic WAV files) generated by a recorder. Take numbers are auto-incrementing. Take numbers are added to the end of the file name.

Take list

Separate from a file list, a take list consolidates related files such as a group of monophonic WAV files generated by a single take and presents them as a single take.

Test tone

See tone oscillator.

Timecode

A numerical clock value expressed in hours:minutes:seconds:frames, i.e. 04:59:39:05, used to synchronize cameras, video decks, and audio recorders. Timecode requires clocks on devices to be synchronized, either through a wired or wireless connection between devices, or through a process called "jam sync" where each device, which requires a high-precision clock, runs independently after their clocks are synchronized.

Timecode mode

Sound Devices recorders offer multiple timecode modes. Different modes correspond to different timecode workflows. Common modes available in Sound Devices recorders include:
 record run - timecode advances only when recording is engaged
 free run - timecode run continuously, typically with the start of production being at 0 hour
 24 hour - similar to free run except the start time corresponds to time-of-day
 ext TC - the recorder applies the value of an external timecode source.

Tone oscillator

A sound generator producing a sine wave tone at a given frequency at a given output level. With its known output level tone oscillators are helpful to set gain structure between audio equipment.

Track

A single recorded audio signal. Common recorded tracks are the main left/right master audio bus and isolated (ISO) channel recordings. ISO tracks are typically identified by the channel of the same number, e.g. channel 1 is sent to track 1, channel 2 is sent to track 2, etc.

Track arm

Tracks that are active and ready for recording are said to be “armed”. When recording begins all armed tracks begin recording. Depending on the production it may be advantageous to arm and disarm tracks, especially to disarm unused tracks.

Track name

Individual tracks of a multi-track recording can be named to indicate microphone type or character name.

Trim

Also defined in mixers as “gain”, the trim adjustment is the first stage of gain of a microphone or line level input. Typical microphone trim values range from 10 dB to 50 dB, depending on microphone sensitivity and volume of the sound source.

User bits

Static, numeric data that is available as part of a timecode signal. User bits are often used to indicate the date of a file. User bits are four sets of two-digit hexadecimal numbers from 00 to ff.

WAV File

A universal, well-supported file type for sound file recordings. WAV files can contain one or more (up to 65,535) tracks of PCM audio data at any sampling rate and bit depth. A standard WAV file is limited to a maximum file size of 4 GB. Sound Devices uses the WAV extension for recorded files, including for files with Broadcast WAV metadata and WAV RF64 files.

WAV RF64

An extension of the WAV file type that supports file sizes larger than 4 GB. When recording high track count, high sampling rate polyphonic WAV files, the 4 GB size limitation of WAV can be reached quickly. RF64 files larger than 4 GB require recording to a volume type than can support file sizes larger than 4 GB.

Word clock

A reference signal used to synchronize the sampling rate of multiple digital devices.

XLR female

Industry-standard 3-pin locking audio connector for microphone and line-level sources. Predominantly used as an input. Also shown as XLR-F.

XLR male

Industry-standard 3-pin locking audio connector for microphone and line-level sources. Predominantly used as an output. Also shown as XLR-M.

This product incorporates software subject to the BSD license:

Copyright 2001-2010 Georges Menie (www.menie.org)

All rights reserved. Redistribution and use in source and binary forms, with or without modification, are permitted provided that the following conditions are met

* Redistributions of source code must retain the above copyright notice, this list of conditions and the following disclaimer.

* Redistributions in binary form must reproduce the above copyright notice, this list of conditions and the following disclaimer in the documentation and/or other materials provided with the distribution.

* Neither the name of the University of California, Berkeley nor the names of its contributors may be used to endorse or promote products derived from this software without specific prior written permission.

* THIS SOFTWARE IS PROVIDED BY THE REGENTS AND CONTRIBUTORS "AS IS" AND ANY EXPRESS OR IMPLIED WARRANTIES, INCLUDING, BUT NOT LIMITED TO, THE IMPLIED WARRANTIES OF MERCHANTABILITY AND FITNESS FOR A PARTICULAR PURPOSE ARE DISCLAIMED. IN NO EVENT SHALL THE REGENTS AND CONTRIBUTORS BE LIABLE FOR ANY DIRECT, INDIRECT, INCIDENTAL, SPECIAL, EXEMPLARY, OR CONSEQUENTIAL DAMAGES (INCLUDING, BUT NOT LIMITED TO, PROCUREMENT OF SUBSTITUTE GOODS OR SERVICES; LOSS OF USE, DATA, OR PROFITS; OR BUSINESS INTERRUPTION) HOWEVER CAUSED AND ON ANY THEORY OF LIABILITY, WHETHER IN CONTRACT, STRICT LIABILITY, OR TORT (INCLUDING NEGLIGENCE OR OTHERWISE) ARISING IN ANY WAY OUT OF THE USE OF THIS SOFTWARE, EVEN IF ADVISED OF THE POSSIBILITY OF SUCH DAMAGE.

Two Level Segregated Fit memory allocator, version 3.1.

Written by Matthew Conte

[Http://tlsf.baisoku.org](http://tlsf.baisoku.org)

Based on the original documentation by Miguel Masmano:

<http://www.gji.upv.es/tlsf/main/docs>

This implementation was written to the specification of the document, therefore no GPL restrictions apply.

Copyright (c) 2006-2016, Matthew Conte All rights reserved.

Redistribution and use in source and binary forms, with or without modification, are permitted provided that the following conditions are met:

* Redistributions of source code must retain the above copyright notice, this list of conditions and the following disclaimer.

* Redistributions in binary form must reproduce the above copyright notice, this list of conditions and the following disclaimer in the documentation and/or other materials provided with the distribution.

* Neither the name of the copyright holder nor the names of its contributors may be used to endorse or promote products derived from this software without specific prior written permission.

** THIS SOFTWARE IS PROVIDED BY THE COPYRIGHT HOLDERS AND CONTRIBUTORS "AS IS" AND ANY EXPRESS OR IMPLIED WARRANTIES, INCLUDING, BUT NOT LIMITED TO, THE IMPLIED WARRANTIES OF MERCHANTABILITY AND FITNESS FOR A PARTICULAR PURPOSE ARE DISCLAIMED. IN NO EVENT SHALL MATTHEW CONTE BE LIABLE FOR ANY DIRECT, INDIRECT, INCIDENTAL, SPECIAL, EXEMPLARY, OR CONSEQUENTIAL DAMAGE (INCLUDING, BUT NOT LIMITED TO, PROCUREMENT OF SUBSTITUTE GOODS OR SERVICES; LOSS OF USE, DATA, OR PROFITS; OR BUSINESS INTERRUPTION) HOWEVER CAUSED AND ON ANY THEORY OF LIABILITY, WHETHER IN CONTRACT, STRICT LIABILITY, OR TORT (INCLUDING NEGLIGENCE OR OTHERWISE) ARISING IN ANY WAY OUT OF THE USE OF THIS SOFTWARE, EVEN IF ADVISED OF THE POSSIBILITY OF SUCH DAMAGE.

SOUND  DEVICES

Post Office Box 576
E7556 State Rd. 23 and 33
Reedsburg, Wisconsin 53959 USA

support@sounddevices.com

+1 608.524.0625 main
+1 608.524.0655 fax
800.505.0625 toll free

www.sounddevices.com